

"Towards an Earth-Moon Economy - Developing Off-Planet Resources"

Moon Miners' Manifesto



www.MMM-MoonMinersManifesto.com

MMM Classic Themes **The Lunar Economy**

A Lunar Economy will Rest on 3 Foundations

- 1. Elements fairly abundant on the Moon**
Iron, Aluminum, Magnesium, Titanium – the four “engineering metals” – plus Oxygen, Silicon, and Calcium. Any products that can be made for local use from these and other available elements will represent significant cost savings over “upports” of equivalent items made on Earth’s surface
- 2. The Moon sits on the shoulder of Earth’s Gravity**
Well so that “downports” to markets in **Low Earth Orbit** (space stations, space hotels, space industrial parks, etc.) and **Geosynchronous Orbit** (space platforms hosting hundreds of satellites; solar power satellites and power relays) will have a 23:1 cost advantage in terms of shipping costs over equivalent items made on Earth’s surface.
- 3. The MUS/cle Strategy** – Lunar industries focus on items that are **Massive, Unitary** (many needed), and **Simple** while things that are complex, lightweight, and/or **electronic** are shipped up from Earth.

Here we bring together the many articles that have developed these themes through the years.

Related Online Documents:
MUS/cle Strategy for Lunar Industrial Diversification
http://www.moonsociety.org/publications/mmm_papers/muscle_paper.htm

TANSTAAFL!

“There Ain’t No Such Thing As A Free Lunch!”

– Robert A. Heinlein
In “The Moon is a Harsh Mistress”



The Moon Would Seem to be a Tough Nut to Crack Until we look Closer

At first we may not be able to produce “first choice” alloys and other building and manufacturing materials, but what we can produce early on will be adequate to substitute for enough products that the gross tonnage of imports from Earth can be cut to a fraction. Power Generation is essential.

Better, as we point out in Foundation 2 above, the Moon has the real estate advantage of “location, location, location.” As a result, anything produced on the Moon could be shipped to space facilities in Low Earth Orbit (LEO) and Geosynchronous Orbit (GEO) at a cost advantage of equivalent products manufactured on Earth. Thus the cost of importing to the Moon those things that cannot yet be manufactured there, could be offset by exports of Lunar manufactured goods and materials to markets in LEO and GEO. Production of consumer goods will be important and enterprise will be a key factor.

It will take time, but financial break-even is possible in time. The obstacles are great. But once you look closely at the options, these obstacles fall in the ranks of those that faced

MMM Theme Issues: The Lunar Economy - Years 1-25 Dec 1986 - Nov 2011

pioneers of other frontiers on Earth in eras gone by. Establishing and then elaborating the roots and possibilities of a lunar economy sufficient to support permanent pioneer frontier settlements are there, and treating them one by one has been a major theme of Moon Miners' Manifesto through the years. **MMM**

PUBLICATION SEQUENCE INDEX MMM THEMES: THE LUNAR ECONOMY

- MMM # 2 "M is for Market"
- MMM # 3 Moon Mall
- MMM # 4 Paper Chase II
- MMM # 5 Lunar Architecture
- MMM # 6 "M is for Missing Volatiles;" "M is for Methane & 'Mmonia;"
"M is for Minimizing the cost of importing Methane, Ammonia, and Hydrogen"
- MMM # 16 Glass-Glass Composites & "Spin-Up"
- MMM # 18 A Strategy For Following Up Lunar Soil-Processing With Industrial M.U.S.-c.l.e.
- MMM # 22 1st Exports
- MMM # 23 Helium-3
- MMM # 24 Gas Scavenging
- MMM # 32 Import Export Equation; Diversification Subsidies; Not In My Back Yard (NIMBY):
The Import/Export Sleeper; Gross Imports that Could Count as Net Exports
- MMM # 34 Recycling; The "4th R"
- MMM # 38 Primage: Key to Lunar Industrial-Agricultural Success;
How an Earth-Moon-Mars Economy Might Work
- MMM # 65 Lunar Industrialization: Substitutions Game; Fast Road to Lunar Industrial "MUS/cle;"
Stowaway Imports
- MMM # 69 Producing for Export: Bringing Home the Bacon and Brass;" Tourist Earnings;
Cosmotive Inc. (Scavenging and reconditioning Orbital "Debris")
- MMM # 77 Homestead Furnishings and Decor as a Cottage Industry
- MMM # 88 Profits from Entertainment Ventures; Prize Lunar Real Estate
- MMM # 91 MMM Dictionary Entry "Commercial Space;" Commercial Moonbase Workshop
- MMM # 116 Uranium and Thorium and a Lunar Nuclear Fuels Industry
- MMM # 123 Thorium the Key to Opening Up Mars
- MMM # 126 "Potentiation" - Getting Through the Nightspan on the Moon's Own Terms
- MMM # 128 Justification for Early Operation of a Lunar Mining Facility
- MMM # 129 Self Sufficiency Tests and Goals; Balance of Trade Questions
- MMM # 132 "Spinning-up" Frontier Enterprise Profitable for both Earth & Space
- MMM # 135 Cast Basalt: Startup Industry With Two Great Tricks
- MMM # 144 Stay-at-home Shadow Settlers Brains & Skills "Tele-Participate" to reduce labor
costs on the Moon; Moongas: as the Moon Burps
- MMM # 149 Homestead Gardens as Early Cottage Industries
- MMM # 155 "As Long as We're Here" Secondary Profit Generators for Moon and Mars Bases
- MMM # 165 Deep Pocket Heroes to the Rescue of the Space Frontier?
- MMM # 168 Working Vacations: Change of Pace and Scenery for Lunan Pioneers
- MMM # 174 Modular Container Factories to Industrialize Early Settlements
- MMM # 181 Human-Robot Synergies
- MMM # 188 Zero-Mass Products & Services as a Major Part of a Lunar Frontier Economy
- MMM # 190 CO-OPs as Enterprise Accelerators
- MMM # 191 First Lunar Manufacturing Industries, before we start building habitat modules

MMM Theme Issues: The Lunar Economy - Years 1-25 Dec 1986 - Nov 2011

- MMM # 196 Scientific-Industrial Utilization of the "Lunar-Unique" Environment: Marius Hills
- MMM # 198 Outpost Trap: Technologies Needed to Break Free: I. Transportation Technologies; II. Expansion-friendly Modular Outpost Architectural Language, Construction/Assembly Systems Design; III. Locate for local, regional, and global expansion options; Teleoperation for Maximum Productivity
- MMM # 199 Outpost Trap: IV: ISRU, In Situ Resource Utilization; V Industrial Diversification Enablers; VI The Entrepreneurs; VII Moonbase Personnel
- MMM #200 The Outpost Trap: VIII: Strategies for Organizations tasked with making it happen; IX: A Lunar Analog Station Program can pave the way, if well-focused
- MMM # 207 A Spartan 11-Step Industrialization Scenario for a Lunar Mining Base: Magnesium: Workhorse Metal for the Lunar Frontier
- MMM # 208 Service Hooks for a Commercial Moonbase
- MMM # 209 Thinking Outside the Mass-Fraction Box; NASA's Lunar Architecture Design Goals are not what we need to maximize lunar presence investment
- MMM # 210 Thinking Outside the Mass-Fraction Box: ii. Improving NASA's Design Goals
- MMM # 211 Thinking Outside the Mass-Fraction Box: iiii. Power of Leveraging Concurrent Space Developments to deliver much more to the Moon; Hewn Basalt Products
- MMM # 216 Shadow Pioneers; KREEP Deposits
- MMM # 221 Investing in Fuel Tank Infrastructure in the Architecture of Lunar Exploration; Paradigm Shift (in Fuel Tank Infrastructure); Raw Glass Products
- MMM # 224 An International Lunar Research Park; Research & Development Priorities List: 1-5 Magnesium and Iron: Lunar Workhorse Metals
- MMM # 229 Resources of Mare Imbrium and Oceanus Procellarum; Lunar Industrialization: Defining the Lunar Industrial Seed: What Comes Before and How?
- MMM # 230 Lunar Industrialization: Defining Lunar Industrial Seed: What Comes Before How?; Defining the Lunar Industrial Seed: Manufacturing
- MMM # 231 Lunar Industrial Seed: The "cle" part of Industrial Development MUS/cle Strategy; A Basalt Fibers Industry
- MMM # 234 Lunar Basalt: What, Where, Critical Role for Lunar Industrialization & Settlement
- MMM # 235 Successful Opening of a Lunar Frontier Will Require More Than One Settlement
- MMM # 237 Research & Development Projects For an International Lunar Research Park
- MMM # 238 "In This Decade:" 3 words which won us the Moon Race but lost us the Moon; For the Sake of Science, Science should not be in the Lunar Exploration Driver's Seat
- MMM # 239 Could the Best Place to Mine Asteroids be on the Moon?: An Avatar Moonbase?
- MMM # 242 Telepresence-operated "Robonauts" will revise all "Scenarios;" Role of Robonauts & Robots on the Moon once Humans have settled in to stay; O'Neil's High Frontier Updated and Modified; New Space Age of Human-Robot Synergy
- MMM # 244 Could the "Space Experience" Sector Open the Moon Faster, for Less?
- MMM # 246 Could Some Lunar Lavatubes be Hiding Valuable Resources? - Speculation
- MMM # 247 Moon Mining Machines: A Materials Challenge; Lunar Iron and Alloys of Iron
- MMM # 248 10 Billion Dollars to Industrialize the Space?; Postscript to the preceding article; Differences between this and former Visions
- MMM # 249 A Prelude to Space Industrialization; The Moon: What's in it for Earth? Part II: Lunar Materials to Grow Earth's Economy
- MMM #259 Lunar Toll Roads: Taming the Magnificent Desolation of the "Out-Vac"

Comment: As you can see from this list of topics, we have tried to approach the subject of a many-faceted Lunar Economy invigorating the greater Cis-Lunar Earth-Moon Economy. We

MMM Theme Issues: The Lunar Economy - Years 1-25 Dec 1986 - Nov 2011

believe that the prospects are greater than any of us can imagine from our current position in history. We have tried to illuminate many of the potential roots of this economy, going well beyond mainstream current speculation, but grounded in real potential, given the Moon's makeup and key position on the shoulder of Earth's Gravity Well. Enjoy!

Peter Kokh, Dave Dietzler, Dave Dunlop and others

THEME THREADS INDEX - THE LUNAR ECONOMY

PRELUDE

- MMM # 16 Glass-Glass Composites & "Spin-Up"
- MMM # 18 A Strategy For Following Up Lunar Soil-Processing With Industrial M.U.S.-c.l.e.
- MMM # 22 1st Exports
- MMM # 132 "Spinning-up" Frontier Enterprise Profitable for both Earth & Space
- MMM # 144 Stay-at-home Shadow Settlers Brains & Skills "Tele-Participate" to reduce labor costs on the Moon
- MMM # 155 "As Long as We're Here" Secondary Profit Generators for Moon and Mars Bases
- MMM # 165 Deep Pocket Heroes to the Rescue of the Space Frontier?
- MMM # 176 Tele-Crafted Art Objects
- MMM # 181 Human-Robot Synergies
- MMM # 188 Zero-Mass Products & Services as a Major Part of a Lunar Frontier Economy
- MMM # 198 Outpost Trap: Technologies Needed to Break Free: I. Transportation Technologies; II. Expansion-friendly Modular Outpost Architectural Language, Construction/Assembly Systems Design; III. Locate for local, regional, and global expansion options; Teleoperation for Maximum Productivity
- MMM # 199 Outpost Trap: IV: ISRU, In Situ Resource Utilization; V Industrial Diversification Enablers; VI The Entrepreneurs; VII Moonbase Personnel
- MMM #200 The Outpost Trap: VIII: Strategies for Organizations tasked with making it happen; IX: A Lunar Analog Station Program can pave the way, if well-focused
- MMM # 208 Service Hooks for a Commercial Moonbase
- MMM # 209 Thinking Outside the Mass-Fraction Box; NASA's LunaR Architecture Design Goals are not what we need to maximize lunar presence investment
- MMM # 210 Thinking Outside the Mass-Fraction Box: ii. Improving NASA's Design Goals
- MMM # 211 Thinking Outside the Mass-Fraction Box: iil. Power of Leveraging Concurrent Space Developments to deliver much more to the Moon; Hewn Basalt Products
- MMM # 216 Shadow Pioneers
- MMM # 221 Investing in Fuel Tank Infrastructure in the Architecture of Lunar Exploration; Paradigm Shift (in Fuel Tank Infrastructure); Raw Glass Products
- MMM # 224 An International Lunar Research Park; Research & Development Priorities List: 1-5
- MMM # 237 Research & Development Projects For an International Lunar Research Park
- MMM # 238 "In This Decade:" 3 words which won us the Moon Race but lost us the Moon; For the Sake of Science, Science should not be in the Lunar Exploration Driver's Seat
- MMM # 239 Could the Best Place to Mine Asteroids be on the Moon?
- MMM # 244 Could the "Space Experience" Sector Open the Moon Faster, for Less?

ISRU - "IN SITU" (ON LOCATION) RESOURCE DEVELOPMENT

- MMM # 16 Glass-Glass Composites
- MMM # 18 A Strategy For Following Up Lunar Soil-Processing With Industrial M.U.S.-c.l.e.
- MMM # 116 Uranium and Thorium and a Lunar Nuclear Fuels Industry
- MMM # 126 "Potentiation" - Getting Through the Nightspan on the Moon's Own Terms

MMM Theme Issues: The Lunar Economy - Years 1-25 Dec 1986 - Nov 2011

- MMM # 128 Justification for Early Operation of a Lunar Mining Facility
- MMM # 129 Self Sufficiency Tests and Goals; Balance of Trade Questions
- MMM # 135 Cast Basalt: Startup Industry With Two Great Tricks
- MMM # 144 Moongas: as the Moon Burps
- MMM # 174 Modular Container Factories to Industrialize Early Settlements
- MMM # 196 Scientific-Industrial Utilization of the "Lunar-Unique" Environment: Marius Hills
- MMM # 207 A Spartan 11-Step Industrialization Scenario for a Lunar Mining Base:
Magnesium: Workhorse Metal for the Lunar Frontier
- MMM # 216 KREEP Deposits
- MMM # 224 Magnesium and Iron: Lunar Workhorse Metals
- MMM # 229 Resources of Mare Imbrium and Oceanus Procellarum; Lunar Industrialization:
Defining the Lunar Industrial Seed: What Comes Before and How?
- MMM # 230 Lunar Industrialization: Defining Lunar Industrial Seed: What Comes Before How?;
Defining the Lunar Industrial Seed: Manufacturing
- MMM # 231 Lunar Industrial Seed: The "cle" part of Industrial Development MUS/cle Strategy;
A Basalt Fibers Industry
- MMM # 234 Lunar Basalt: What, Where, Critical Role for Lunar Industrialization & Settlement
- MMM # 239 Could the Best Place to Mine Asteroids be on the Moon?:
- MMM # 246 Could Some Lunar Lavatubes be Hiding Valuable Resources? – Speculation
- MMM # 247 Moon Mining Machines: A Materials Challenge; Lunar Iron and Alloys of Iron
- MMM # 248 10 Billion Dollars to Industrialize the Space?; Postscript to the preceding article;
Differences between this and former Visions

SETTLEMENT DOMESTIC FREE ENTERPRISE ECONOMIES

- MMM # 3 Moon Mall
- MMM # 4 Paper Chase II
- MMM # 5 Lunar Architecture
- MMM # 6 "M is for Missing Volatiles;" "M is for Methane & 'Mmonia;"
"M is for Minimizing the cost of importing Methane, Ammonia, and Hydrogen
- MMM # 77 Homestead Furnishings and Decor as a Cottage Industry
- MMM # 88 Profits from Entertainment Ventures; Prize Lunar Real Estate
- MMM # 149 Homestead Gardens as Early Cottage Industries
- MMM # 168 Working Vacations: Change of Pace and Scenery for Lunan Pioneers
- MMM # 190 CO-OPs as Enterprise Accelerators
- MMM # 191 First Lunar Manufacturing Industries, before we start building habitat modules
- MMM # 235 Successful Opening of a Lunar Frontier Will Require More Than One Settlement
- MMM #259 Lunar Toll Roads: Taming the Magnificent Desolation of the "Out-Vac"

MOON-EARTH TRADE

- MMM # 22 1st Exports
- MMM # 23 Helium-3
- MMM # 24 Gas Scavenging
- MMM # 32 Import Export Equation; Diversification Subsidies; Not In My Back Yard (NIMBY):
The Import/Export Sleeper; Gross Imports that Could Count as Net Exports
- MMM # 38 Primage: Key to Lunar Industrial-Agricultural Success;
How an Earth-Moon-Mars Economy Might Work
- MMM # 65 Lunar Industrialization: Substitutions Game; Fast Road to Lunar Industrial "MUS/cle;"
Stowaway Imports
- MMM # 69 Producing for Export: Bringing Home the Bacon and Brass;" Tourist Earnings;

MMM Theme Issues: The Lunar Economy - Years 1-25 Dec 1986 - Nov 2011

Cosmotive Inc. (Scavenging and reconditioning Orbital "Debris")

MMM # 91 MMM Dictionary Entry "Commercial Space;" Commercial Moonbase Workshop

MMM # 249 A Prelude to Space Industrialization; The Moon: What's in it for Earth?

Part II: Lunar Materials to Grow Earth's Economy

MOON-MARS-ASTEROID TRADE

MMM # 123 Thorium the Key to Opening Up Mars

MMM # 239 Could the Best Place to Mine Asteroids be on the Moon?

MMM # 2 February 1987

Essays in "M"

M IS FOR MARKET:

The customary "prospectus" for the Moon is that it will be a major, or the major, supplier of liquid oxygen to low Earth orbit depots and of raw ores to L5 colonies or "Space Settlements" where it will be turned into metal alloy components of more space colonies and solar power satellites, the slag left over being used for shielding. Really, this depends on where people actually choose to live, how big the lunar settlement becomes, and whether it chooses to deliver low value raw materials or higher price value-added processed materials and / or finished goods. The assumption that the great bulk of manufacturing will be done at L5 rather than on the Moon on the grounds that humans cannot tolerate 1/6th G for long is an untested, unproven, unwarranted, and gratuitous opinion. There is enough room, enough of a market, and enough volunteers for both kinds of settlements. The rivalry between L5 colonies and the Moon will be both healthy and productive.

LUNOX Corporation, selling liquid oxygen to the various low Earth orbit (LEO) space stations and staging depots, probably in exchange for equal volumes of liquid hydrogen (nitrogen, ammonia, methane will also be needed) may well be the Moon's first employer. But current writing shows lack of imagination. Raw materials from the Moon can be processed into many things that can be sold and delivered to LEO at great cost advantage, e.g. modules and trusses of the space station itself, windows and glassware, ceramic table ware, fiberglass insulation and fabrics, tools and instruments, some furniture items, and so on. And all of these items will find a market in GEO (Earth synchronous orbit) and L5 as well. LUNOX will supply oxygen not only as fuel oxidizer but as the major component of water and the breathable component of air. Even food items grown on the Moon with "upported" hydrogen, carbon, and nitrogen are still about 50% lunar oxygen and can be delivered to LEO, GEO, and L5 more cheaply from the Moon than from the Earth.

Even the heavy parts of satellites might better be made on the Moon to be mated with the lighter "works" in an LEO or L1 station. The hulls for ships to take men to Mars might better be made on the Moon, and on and on and on. The day may come when competition from the Moon restricts Earth-bound aerospace giants to producing high value light weight components that require materials that are not abundant on the Moon, e.g. copper, gold, platinum, silver, tin, niobium, hydrocarbon plastics, etc.

Yes, the markets are there, and the Moon can pay its way!

MMM

MMM # 3 March 1987

MMM Theme Issues: The Lunar Economy - Years 1-25 Dec 1986 - Nov 2011



Moon Mall

[The second in a series of articles on the need to predevelop the SOFTWARE for a Lunar Civilization]

By Peter Kokh < kokhmmm@aol.com >

I remember as a young man too many years ago [1955] my first time in Hudson Bay Company (yes, the original Canadian Trading Co.) department store in Calgary Alberta. How impressed I was by the great variety of goods imported from all over the British Commonwealth -- an abundance of choices unsuspected by the shopper in Milwaukee's Gimbel's or Schusters of that era. Things are different now. Today's shopper in any mall in America is confronted with a bewildering variety of offerings from all over the world. No one is limited to the goods and services made in his/her own city or town. Indeed, to be so limited, even in a great world-class city like Chicago, New York, or Montreal, would be quite a come down.

How will it be for the shopper in a lunar or Martian mall the first few decades? The settlements will be small, though growing, and "upports" from Earth's gravity well will be prohibitively expensive. Almost certainly and without exception, they will be restricted to items, and even to mere components of items, that are both indispensable on the new worlds and as yet impossible to manufacture locally. For everything else, the settlers must be willing to make do with local resources and materials as best they can. No one ever said pioneering would be easy. The frontier may be exciting, but like frontiers from time immemorial, it will of necessity have its rough edges.

Will this mean one style, one color only of dishes, for example? One model, one color only for radios, stereos, and television sets? Only one style and color of sofa, or chair, or dresser? Uniform-like sameness in clothing? Unless we do some resourceful and ingenious planning now the answer might well be yes; and the consumers' paradise of Earth will have no counterpart in the consumers' pits on the Moon and Mars. There will simply be too few people to make more than the simplest variety of goods with no supplemental selection available through the Sears or any other mail order catalog.

Two approaches to this problem suggest themselves: one high tech, one low. For a small factory, changing styles, colors, shapes, etc. of whatever it makes in order to satisfy a variety of tastes usually involves expensive dies, molds, etc., and extensive downtime for setup changes. The challenge here is to design production equipment which is set-up friendly so that limited runs can be made on a dial-a-style or insert-a-card basis with little loss in efficiency. Some modern production facilities on Earth are already being designed in the fashion. I am not privileged to work at one. In this way, just as one can dial a pretty pattern by the turn of a kaleidoscope, a consumer could order a unique set of dishes, for example, or a unique bolt of fabric. At the least, small production runs in each of many styles could be made without extra expense. Without this commitment to design Lunar or Martian factories to produce such kaleidoscopic product lines, life on the new worlds will be very drab.

[In the decades since this was written, computer aided manufacturing techniques have indeed made all this possible.]

Remember, the people back on Earth won't care, and governments will give it bottommost priority. It's up to us to see that such possibilities come to realization.

The second approach which might work well on some lines of goods or be available as an alternative choice to the Lunar or Martian consumer is for the factory to produce (either exclusively or in addition to a regular line) a line of unfinished goods -- ready for the consumer or venturesome craftsman to custom finish for him/herself or for resale. Some examples might be ready-to-glaze ceramic ware, ready-to-upholster furniture frames, and electronics chases

MMM Theme Issues: The Lunar Economy - Years 1-25 Dec 1986 - Nov 2011

sold without cabinets or with unfinished cabinetry, ready to dye, print, or otherwise embellish plain fabric bolts. Such secondary or co-manufacturing or custom craft finishing will likely become an important part of the frontier economy. And the person with crafting skills who can take a common ho-hum product and give it a unique and interesting touch might well enjoy the highest local prestige and social status. Those who do not have -- or refuse to develop -- the talent to custom finish purchased raw goods or who lack the income to pay someone else to put such touches on what they buy, might well be condemned to a home filled with the dull, boring, and commonplace.

Lunar and Martian society will greatly reflect this totally new set of rules in the consumer sport of acquiring a satisfying and personality-expressing collection of goods. On the Moon and Mars will dawn the new golden age of the artisan and craftsman. A "designer" item on these new worlds will mean something quite different from on Earth, for it will signify not a mass produced edition of a product designed by a famous name with high snob appeal, but rather a line of unfinished goods which have been designed to be easily, satisfyingly, interestingly, and kaleidoscopically finishable. And so there will be designer mediums, designer palettes, and designer frames and chases, etc. The designer who leaves the most scope for unique finishability will have the most honor.

Prospective settlers may be screened and accepted or rejected not only on the basis of their primary skill and occupation or profession but also on the basis of what they can contribute by their secondary talents, skills, hobbies, and avocations. If the new settlements are to avoid terminal blahs, the population will have to have a very high talent density in comparison with Earth.

We have already pointed out what we must seek to guarantee in the design of production equipment shipped to the Moon or Mars. We must also seek to guarantee a high priority for artistic and craft talent amongst the selection criteria for prospective settlers.

But we can make their lot far easier by doing some experimenting beforehand to develop new means of artistic expression limited to the materials and elements commonplace to the new worlds. Lead, gold, silver, copper, etc., are vanishingly present on the Moon, for example. Thus ceramics cannot use glazes based on the lead oxides; certain kinds of stained glass will not be producible; new forms of jewelry will have to be developed; new stains, and paints, and enamels formulated. Pre-clayed soils will be unavailable for ceramics and water will have to be worked into utterly dry Lunar soils to make fireable clay, etc. If those of use who are into arts and crafts here on Earth take Lunar restrictions as a starting point and through lots of work develop work-able new crafts, that will give the colonists a head start. Without such SOFTWARE predevelopment, any Lunar civilization founded on hardware alone will surely suffer a fatal morale collapse. Can you help? MMM

The above essay is online at: www.asi.org/adb/06/09/03/02/003/moonmall.html

MMM # 4 April 1987



Paper Chase II

[Third in a series of articles on the need to pre-develop the Software of a Lunar Civilization]

By Peter Kokh kokhmmm@aol.com

MMM Theme Issues: The Lunar Economy - Years 1-25 Dec 1986 - Nov 2011

On Earth with its vast atmosphere, oceans, and still extensive forests, we can arguably afford to withdraw such organic ingredients as hydrogen and carbon from the environmental cycle in the form of paper, plastics, etc. After all, Nature has been doing the same thing, "banking" these elements for geologically long times as coal, oil, and gas.

On the Moon the situation is quite different. Hydrogen and carbon do exist in amounts worth scavenging in the upper layers of Lunar soil, put there by the incessant solar wind. From Apollo samples we might expect every thousand tons of soil processed to yield (besides over 400 tons of oxygen) one ton of hydrogen, 230 lbs. of carbon, and even 164 lbs. of nitrogen (source: Stuart Ross Taylor. Planetary Science: A Lunar Perspective. Lunar and Planetary Institute, 1992, p 159). This is hardly abundance. Polar permashade fields certainly must be searched, but this scenario requires that the Moon's axis will not have shifted more than a degree or so in the past 3.5 billion years: a tall order. If any ices of water or carbon oxides are found there, they will certainly be needed to expand the biomass of the colony. Withdrawal and banking will still be quite out of the question. Hydrogen and carbon for non-biological uses will still be priced as "import elements."

[The above was written in 1987, eleven years before Lunar Prospector confirmed the existence of ice deposits at both poles. Yet the caution remains. Even billions of tons of hydrogen, carbon, and nitrogen (presuming that the ice contains carbon and nitrogen oxide ices as well, which one might expect if the source is comet impacts) -- even so much is not enough to support (a) lunar biosphere(s) if the population on the Moon grows to a considerable size. A conservative approach is still the best strategy, if we are not to stunt the growth of lunar development -- Ed.]

Paper is basically cellulose, a carbohydrate, half hydrogen & carbon, half oxygen. Its production in modern forms is very taxing on environmental air and water. While this may be a justifiable tradeoff on the bounteous Earth, the toxic burden of its production would soon overwhelm the very limited environments of Lunar (or in-space) settlements even if "waste papers" were recycled 100% (which would necessitate brainwashing all would-be settlers.) Luna City (and "New Tucson" at L5 as well) must be a paperless society. Throwaway addicts will argue this, of course, but then addiction has always been resistant to treatment.

What will this mean in practical terms? First let's set everyone's mind (some double entendre here) at ease. With so many of the engineering problems of human outmigration already solved, it would be ironic if having to apply fiberglass to one's exit zone proved to be the show stopper. Fortunately toilet tissue that is 100% biodegradable and environment friendly is already being made and sold on the mass market. This is also a fast cycling usage, the hydrogen and carbon involved not long withdrawn from circulation. "But ye who enter here," (the gates of Moon settlements) "forever give up all hope" of paper plates, cups, towels, napkins, and junk mail.

Now a paperless society, Lunar or L5, is an enormous challenge and we had better begin preparing for it. A entire spectrum of alternatives must be developed and ready-to-go to address the diversified applications of paper in our civilization that have so insinuated themselves into our way of life as to almost define it.

Books, magazines, newspapers: electronics to the rescue, you say. Well, only if there are some quantum leap improvements over what is available today. Cathode ray tube (CRT) eye strain is a common enough complaint to show that the final format of electronic reading media is not yet on the scene. The Lunar "EZ-Read" must not only be eye-friendly, it must be lightweight, even pocketable. Rainbow-color capacity should not be a luxury.

Electronic books, magazines, and newspapers, etc. to be inserted into the reader must be quite compact especially if hydrocarbon plastics are involved so that the weight ratio to paper replaced is as high as possible. All metal alloy and / or silicon would be the best.

Downloading from central library / databases may well fill much of the need. But if this is all that is available, the right to freedom of information will be imaginary. The Lunar Bill of Rights (even the American one) should include the right to own individual books in whatever

MMM Theme Issues: The Lunar Economy - Years 1-25 Dec 1986 - Nov 2011

applicable format. The desire to own one's own core library should be unroot-able in anyone who fancies him/herself more than a cog.

However much progress is made on the electronic front, a kosher all-Lunar substitute for organic fiber paper would be most desirable. 100% fiberglass papers have been successfully produced, but so far as I have been able to determine, these are used primarily as filter papers. If an all fiberglass paper with a suitable texture or "hand" can be developed, then a method of printing it without organic based inks and toners (using metals and their oxides, for example) must be found. Perhaps some of the research done on the various forms of xerography might indicate directions for further experimentation?

Whatever the eventual repertoire of Lunar print media, one thing is sure. Printed materials will not be physically imported from Earth. Rather whole libraries will be electronically transmitted to Lunar receiving stations to be re-materialized in the new media and formats. And this presents a unique, once-in-history opportunity. The use of appropriate interfaces on the Lunar side of this information stream would allow for spelling reform, modest or drastic (even a whole new alphabet would be possible) of the English language. The merits of pursuing this option are beyond the scope of this article.

[In 1987, when the above was written, the Internet was still very much in the future! As was the Kindle and other "reading tablets."]

Checks, invoices, statements, bills, inventories, etc. The coming "smart card" may point the way to handling these needs. But a whole family of "smart cards" will be needed to handle the full variety of personal, in-house, and commercial transactions.

Cereal boxes and all other food item packaging: There can be no exception to the use of glass, fiberglass, metal, and foil. Plastic is just as taboo as paper. Food will probably be available only in bulk, and one would purchase the desired container type and size separately, a strong motive for reuse. The same goes for most other normally convenience packaged items.

Labels, tags, and stickers: fiberglass papers and foils with not-yet-developed kosher ways of imprinting or perhaps embossing them seem the only way. Some mechanical way of affixing them must be worked out as hydrocarbon and other organic adhesives are likely to be unavailable.

Paper bags, gift wrap, cardboard boxes, and dividers: Ingenuity must be applied to such kosher materials as metal and fiberglass fabrics and netting and reinforced foil (how about a vacuum laminated foil/fiberglass gauze/foil sandwich?)

Greeting cards and love notes: One can foresee a non-commercial and unpoliceable use of homemade art papers (such as are now well represented in art fairs) and vegetable inks for this purpose. Maybe the contradiction of personal mass produced greeting cards will at last give way to something that really does show individual effort. A possible "black market" item.

I am sure I have not covered it all, but I hope the idea is clear. Lunar culture in full bloom will be quite different from ours. But one can be assured that given preparation NOW, these differences will not be impoverishing. On the contrary, they should be refreshing and enriching. Certainly there will be lessons learned that may help Earth bound culture find its way to a somewhat less disharmonious relationship with our own host world.

MMM

The above article is online at: www.asi.org/adb/06/09/03/02/004/paperchase2.html

The Above articles and the one following, by addressing what we can and cannot make on the Moon given the relative abundance of key elements, sets limits for the initial Lunar Manufacturing Capacity.

5 May 1987



LUNAR ARCHITECTURE

[Fourth in a series of articles on the need to pre-develop the "Software" for a Lunar Civilization]

by Peter Kokh kokhmmm@aOL.COM

Through the years, a variety of suggestions have been made for the erection of the First Lunar Base. Most common is to make use of fully prefabricated shelters (such as space station modules or re-outfitted space shuttle external tank) imported from Earth and / or a low-Earth orbit (LEO) space station and burying these in the Lunar soil. A less expensive method of erecting a base of similar limited scope is Dr. Lowell Wood's plan (of Project Columbus) to use inflatable kevlar (carbon fabric) bags (air pressure would be more than enough both to inflate them and to support the overburden of protective soil).

Construction techniques may seem to be a HARDWARE question. But what is built on the Moon will depend _entirely_ on the philosophy behind our presence there. Without the right SOFTWARE of purpose, nothing significant will happen.

The stated purpose of most lunar base proposals seems shortsighted: to serve as a base for doing Lunar Science (Selenology, but the lazier term Lunar Geology is in vogue) and for mining engineers tending a largely auto-mated operation.

A word about Lunar Science. Few laymen perhaps have as high a "selenology curiosity quotient" as the writer, but science is properly the function of a living community already in place. Many would-be Lunar Scientists want only to titillate their own curiosity and then go home. But our purpose has to be different: to make the Moon a second human world. Science in the long run -- much, much more of it -- will follow naturally, science done not by visitors from Earth but by people who have adopted the Moon as their new home.

The type of small prefabricated initial base described above makes better sense as a construction shack for a much larger facility to be built with as high a percentage of native Lunar materials as is initially possible. T. D. Lin's proposed 90,000 square ft, three level, 210 ft diameter concrete structure might be ideal (see the sketches on the last page of MMM #3) in which 55 tons of terrestrial hydrogen is called for in comparison to 250 tons of Lunar steel, 1500 tons of Lunar highland cement, over 10,000 tons of Lunar soil used as aggregate, and over a million tons of soil used as shielding.

If expansion is to be an afterthought, it will end up being a forgotten dream. Such a truly Lunar base might be large enough to support open-ended goals of developing non-token Lunar agriculture, pilot materials processing industries, and production-scale 100% Lunar sourced building materials and construction / erection equipment and methods. If (expansion is to be an afterthought, it will end up being a forgotten dream (and you can carve that quote in marble). The only base it is worth building on the Moon is one whose function it is to prepare the methods and tools needed to expand into a full blown settlement.

Only if we make it possible for several thousands (not dozens) of people to live on the Moon from generation to generation (not just through short tours of duty) can we:

- (1) develop a Lunar economy that is truly full and autonomous
- (2) develop a genuinely Lunar human culture and civilization to express and unfold potentialities hidden in humanity since the dawn of time ("Be all that you can be")
- (3) say truly, that the human presence on the Moon is more than that caricature we find in Antarctica and that we have securely established humanity beyond Earth. Only then will we begin to cut the umbilical cord that ties us to the womb world.

So Lunar Architecture, or "LunArchitecture", must be a charter function of a bona fide base. Considerations flowing from the goal make several things clear.

MMM Theme Issues: The Lunar Economy - Years 1-25 Dec 1986 - Nov 2011

1. Speed of "labor-light" construction is essential.

To begin with, "Lunarchitects" must develop a system that can provide shelter at a pace sufficient to house settlers as fast as the growing Lunar market / trade / economy can absorb them. This means that not even lip service can be given to the time-honored slow, labor intensive housing construction methods. What is important is to build secure shelter as simply and quickly as possible -- let us be so bold as to aim at one per day per crew!

There is a place for labor-intensive, artful, craft-rich, proud work, and that is in the leisurely discretionary finishing of interiors. This can be do-it-yourself or contracted on a pay-as-you-go basis, etc. and can be stretched out over years or even generations. We'll thus employ the analogs of brickmasons and carpenters for interiors, but they have no place in erecting the pressure shells of Lunar indoor / middoor spaces.

2. The "Dirt Cheap" Goal

The pressure shells of buildings must be literally dirt-cheap. One cannot "live off the land" nor "sleep under the stars" on the Moon. The place for flaunting affluence is in interior finishing. To keep the basic construction "regolith-cheap" two things are necessary: extrusion of the shelter from the site itself and the use of the least amount of construction energy necessary to do the job well.

3. The Concept of the Lunar "Great Home"

The "right to ample living space" ought to be "religiously" pursued, unammendably, unpostponably. Add-on space will be difficult, risky, and expensive. All the pressurized shell-volume that even an extended family might want should be provided at the outset. Young families might make a "cozy place" in only a part of this and slowly grow into the rest. Included should be solarium and garden space large enough to provide a respectable fraction of their food needs and to help to keep their air fresh as well as provide an oasis of serenity and delight. Another bonus of this "right to ample space" approach would be the availability of in-home areas for starting entrepreneurial cottage industries.

It is necessary then to purge the mind of the facile but inappropriate examples of the prefab-ricated space station habitat module. Even if manufactured on the Moon, they would be more energy intensive in their construction and almost guarantee a stiflingly stingy allotment of sardine space in turn for the ever unfulfilled promise of more spacious quarters "when the settlement can afford it."

A limited amount of technological home-work has already been done along lines that would enable the realization of the goals just outlined. We already know that the Lunar soil can be compacted and then sinter-fused with a mobile magnetron, a high-power microwave generator (the idea of Tom Meeks of the University of Tennessee). This would be ideal for road surfaces, floors, and exterior walls set into excavations in the soil. We know that the soil can be melted into cast-basalt slabs ideal for interior partitions and roof segments, with the balance of the excavated soil being replaced on top as shielding while the interior is being pressurized. We know how to build safe periscopic Lunar picture windows (see MMM #1) and heliostats to flood the interior with sunshine.

But much work needs to be done. Using imported epoxy resins as sealers would be prohibitive. At the least, the natural glass-like glazing of the cast and sintered surfaces may well reduce the need for sealant to joints. In the temperature stable Lunar underground environment with no vibration to worry about from wind or occasional mini moonquakes, and no water-table-induced settling to worry about, this sealant may not need to be as flexible as one might think. Perhaps glaze patching would do the job. On site experiments will be needed to prove out these ideas and build production-capacity equipment.

The scandal of totally unnecessary cost multipliers built into the present establishment approach has discouraged many, leading them to settle for the little dream, the token base, in the false hope that it is a foot in the door. We must not be sheepish about insisting on the Big Dream, our only chance! **MMM**

MMM # 6 June 1987

Essays in "M"

By Peter Kokh <kokhmmm@aol.com>

M IS FOR MISSING VOLATILES

The Moon, as compared to our bountiful Earth, is very poor in elements with low boiling points, especially hydrogen (and thus water), nitrogen, and carbon (which is volatile in its usual form as carbon monoxide and/or carbon dioxide.) Other relatively volatile elements, like sodium and phosphorus, for examples, while present in usable and probably sufficient quantities, are less abundant than on Earth. This volatile depletion is one of the tests to which any theory of the Moon's origin must be put.

More importantly, this depletion sets constraints on what is economically possible on the Moon. Any Lunar civilization must import the bulk of the hydrogen (barring polar permashade ice fields*), carbon, and nitrogen it needs for biomass and life-support.

Such a civilization must seek to find inorganic substitutes for non-life related uses to which these elements are put on Earth: wood, paper, plastics, coatings, adhesives, oil, and grease, etc.

[This was written eleven years before the exciting confirmation by the Lunar Prospector orbiting geo-chemical mapper that such polar ice reserves do, in fact, exist. But even at "billions of tons" this is a very limited resource which must be used wisely only for recyclable purposes.

MMM

M IS FOR METHANE & 'MMONIA: (poetic license)

The easiest way to ship the missing volatiles is to combine them as methane (CH₄) and ammonia (NH₃) which are easier to liquefy and handle than liquid hydrogen, especially. But any excess needed hydrogen* would have to be imported in the pure form. (Some hydrochloric acid and hydrofluoric acid might be shipped to co-import any needed chlorine -- to combine with Lunar sodium to make salt -- and fluorine. Both may be needed to endow recycling ore extraction processes.)

To increase import efficiency to 100%, containers can be used which are made exclusively of elements the Moon needs to import. Such usable "tare" could be of metal, like copper, or of easily reduced solid hydrocarbons like polypropylene (CH(CH₃)CH₂)ⁿ

* [Actually, of H, C, and N, it is Nitrogen which will probably be in shortest supply in comparison to the amounts we will need, solely as a buffer gas used with oxygen for breathable "air".

Nitrogen can be conserved by reducing the interior air pressure to half sea-level normal, but with the same amount or partial pressure of oxygen, reduced nitrogen accounting for all of the reduced air pressure. If indeed this shortage does turn out to be critical, it will be a strong incentive to keep ceilings low, thus reducing the cubic volume of air needed per square foot of inhabited space. Goodbye visions of high-domed megastructures for the time being! - Editor.]

M IS FOR MINIMIZING THE COST OF IMPORTING METHANE, AMMONIA, HYDROGEN, Etc:

The Moon's top priority in its program to minimize the cost of its import burden will be to learn to replace (with native elements) or do without non-life-related usages of missing elements. Next in priority will be to develop sources of its import staples (hydrogen, methane, ammonia) that are less costly than upporting them from Earth. Any infant Lunar civilization MUST (or die!) open up other parts of the solar system as part and parcel of an integral and viable NTM economy (NTM = non-terrestrial materials). Mars is so close to having everything that is needed that may be a tendency of Martian Pioneers to be isolationist, not caring to open other space markets. If you want to guarantee widespread Solar System development, best to put

MMM Theme Issues: The Lunar Economy - Years 1-25 Dec 1986 - Nov 2011

your eggs in a basket that is strategically deficient! To have an interesting system-wide economy and commerce you need a system-wide community of interdependent places. Any extraterrestrial game in which the name of the start square is not "LUNA" will be a dud. To those who say the Moon lacks the resources to support a civilization, we have a one word answer: Japan.
MMM

M IS FOR MANNED MISSIONS TO MARS AND ITS MOONS FROM THE MOON:

If you want a mission which is not going to be an Apollo-type dead end, or so weight-restricted as to be a token effort you can do two things:

1. Source as much of your throw weight as possible from the Moon. The spacecraft can be made largely from Lunar materials with their bootstrapping 20:1 advantage.
- 2, Depart, fuel tanks topped off (at least Liquid Oxygen), from high on the shoulder of Earth's gravity well, for example from the L1 Lagrangian point about 40,000 Miles in from the Moon towards Earth. While this would restrict departure to the period of the full moon to head you in the right direction with maximum velocity, the advantage will be so great that you could launch from L1 at several successive full moons on either side of the every-780-days window for the same energy cost as departure from LEO -- low Earth orbit -- at the the heart of the "window."

Looking down the road, manufacturing the building, construction, and mining equipment for use on Mars, Phobos, and Deimos will be a growth industry for the young Lunar settlements. Earth could not compete! [That, in many respects, mining and processing "regolith" on Phobos and Deimos will be very similar to operations on the Moon, makes such synergy all the more sensible.
MMM

MMM # 16 June 1988



Glass-Glass Composites

By Peter Kokh

Glass-glass-composites, more exactly glass-fiber/glass-matrix composites, or simply GGC, are a promising new horizon for construction and manufacture. This new bird in the flock of materials available to man is still inside the eggshell but pecking away at it. What we know of GGC's promise we owe to Dr. Brandt Goldsworthy of Goldsworthy Labs in San Francisco, who at the request of Space Studies Institute in Princeton (SSI) made laboratory-sized samples and investigated their properties (his report is available for 3\$ from Space Studies Institute, PO Box 82, Princeton NJ 08540). His work gives reason to believe that GGC building materials will be as strong as steel or stronger, and considerably less costly in energy terms to manufacture. [Note; the above contact information is no longer valid.]

The occasion for this bit of incubation of a theoretical hunch lies in careful analysis by SSI of the possibilities of producing serviceable metal alloys from the common ingredients in lunar soil. While the Moon is rich in iron -- some of it free uncombined fines -- and other important metallic elements such as aluminum, titanium, magnesium, and manganese, these are just starting points; to make alloys with good working properties, other ingredients in lesser amounts must be added. It turns out that our customary and familiar stable of alloys used on Earth often require recipe ingredients that are not easily or economically isolated from the soil. Furthermore, alloy production takes a great deal of energy and therefore represents a technology direction for a very advanced lunar civilization, and not one for an early base trying

MMM Theme Issues: The Lunar Economy - Years 1-25 Dec 1986 - Nov 2011

to justify its existence with useful exports to LEO or elsewhere. Alloys will come on line someday; it will take young metallurgists without defeatist attitudes ready to scrap Earth-customary alloy formulations and experiment from scratch with available elements until they have a lunar-appropriate repertoire which will serve well. But that is another story. Here we want to explore the tremendous potential of GGCs.

A "Spin-Up" Enterprise Plan

But how can we explore the potential of a laboratory curiosity? We can't. Are we to wait until we get to the Moon and then fiddle around, hoping that we come up with something before the base has its next budget review? You would think so from the present dearth of activity.

Why not haul GGC out of the lab and put it through its paces in the real world? Sure that takes money, but with a little imagination it is easy to see that GGC could become a profitable industry, here and now, on good old Cradle Earth. And if so, our newly acquired expertise and experience will be ready to go whenever the powers that be establish a long-term human foothold on Luna.

What is the realistic market potential that would justify the effort and expense of getting off our bottoms and pre-developing this promising technology now? If we are talking about something only useful for Industrial construction material, then the threshold for successful market penetration is high. Our GGC products must come on-line either cheaper than every competing material or have such superior properties as compared to existing alternatives as to force potential customers to take the gamble. But to limit ourselves, especially at the outset, to such a line of products is not only accepting unnecessary barriers to success, it evidences a great lack of imagination.

Does GGC have a potential for consumer products? This is an important question, for with such products cost can be secondary to other considerations such as visual appeal due to inherent special design and style possibilities, etc. The consumer market could be a much easier nut to crack, and once established and experienced there, our infant industry would be better poised for market entry in the industrial-commercial world.

Before we speculate further, we must take a look at this intriguing new material and put it through the paces to see what we can and can't do with it. Without that, we are building castles in the air.

We have a logical plan of attack for these experiments thanks to the analogy of GGC to a long familiar family of materials with which we have abundant experience: fiberglass reinforced plastic resin composites, the stuff of which we make boat hulls, shower stalls, pick-up toppers, whirlpool spas, corrugated porch roofing, and a host of other handy products. Fiber reinforced plastics or FRPs offer the game GGC entrepreneur a handy agenda for exploring the talents of the new material.

First our enterprising hero will want to see what fiberglass-like fabrication methods GGC is amenable to mimicking. Can (or should) the still hot and workable glass matrix with glass fibers already embedded be draped over a mold to take its form, or be compression molded in a die and press? Can (or should) the glass fiber be set in the mold and then impregnated with the molten glass matrix? (The magic of GGC lies in using two glass formulations: one with a higher melting point from which to make glass fibers, and one with a much lower melting point to serve as the matrix in which the reinforcing fibers are embedded.) Can (or should) the glass fibers be first impregnated with a cold frit of the powdered glass that will form the matrix upon heating in the mold to its fusing point? Once the entrepreneur has learned which fabrication methods work best or can be adapted to the idiosyncrasies of GGC in various test formulations, he is ready for the next round of experimentation.

Fabricating a "piece" of GGC of a certain useful size and shape is only the first victory. We must learn how to machine it: can the material be sawed, drilled, routed, tapped, deburred, etc.? We need to know this before we can design assembly methods. If adhesives are to be

MMM Theme Issues: The Lunar Economy - Years 1-25 Dec 1986 - Nov 2011

used, what works best? Thermal expansion properties of GGC formulation will be important, as well. Once our entrepreneur has done all his hands-on homework, knows what he can do with this new stuff, and has outfitted his starter plant with the appropriate machinery, tooling, and other appropriate equipment, it's time to sit down with his market-knowledgeable partner and decide on product lines.

But let's back up a moment. We said we were going for the consumer market as the ideal place to get our feet wet, and for this market one thing is paramount: visual appeal. So we go back to the lab and start playing around with our formulations. Glass of course is easily colored. Coloring the matrix glass will not provide us with a distinctive product. But colored glass fibers in a transparent glass matrix suggest tantalizing possibilities. The fibers could lie in random directions, be cross-hatched or woven, swirled, or combed to give an apparent grain. We will want to see which of these suggestions are most practical, which have the most stunning and distinguished consumer eye-appeal, etc., all without compromising the strength of our material. As to the colors: black, green, brown, blue, cranberry, and amber would give us an ample starter palette. But before buying up binfulls of the needed ingredients we could do some inexpensive footwork, using abundant and inexpensive green and brown bottle glass for our fibers to give us a first feel for likely results of this avenue of product enhancement. Our homework done, we're ready to burst onto the world scene.

Our recycled long-empty plant (the rent is cheap and a lease wasn't necessary) has been humming for a while now. Production hasn't begun because the designers are still working on the molds and dies for the introductory product line. Buyers and outlets are being lined up. At last Lunar Dawn Furniture Company is ready to greet the unsuspecting world. At first we produce only (stunning of course) case goods: coffee and end tables, etageres and book cases and bedroom sets, etc. Then we introduce a line of tubular patio furniture that makes the PVC kind look gauche. Next we branch into an upholstered line with beautiful external frames. Office furniture, striking unbreakable fluted glass lamp shades, stair and balcony railings, and unique entry doors are our next targets. Our prices are somewhat high at first, at least with the initial lines, but we were the rage at the fall furniture show in North Carolina and the spring Home Shows in every town. Lunar Dawn takes it's place beside Early American, Mediterranean, Danish Modern, and Eighteenth Century English.

We introduce less expensive but still appealing lines and franchise our operations, targeting especially the less developed nations that need to curtail their forest-razing and which have an abundance of the raw materials needed for glass making. But we also begin to diversify into the commercial and industrial markets. We've learned to make beams and panels and now offer a whole line of architectural systems for competition with steel and aluminum pole buildings, etc. One of our branches is now marketing GGC conduit and pipe at competitive prices. Another is offering a full range of clear non-laminated safety glass for buildings and vehicles.

Meanwhile, we are not resting on our laurels in the consumer world. Casings for small appliances, cookware, ovenware, and table ware; handles, wash basins, and countertops; boat hulls for boulder-studded white water use; all are now available in GGC. A big hit with the fans is our indestructible flagship in the sports world, our GGC bodied Demo Derby Dragon. The same car has won its first dozen events and looks none the worse for it.

Of course, we've long since abandoned the cumbersome GGC or Glass-Glass-Composite tags. The public got what it needs, a simple one syllable pigeonhole. We're known and recognized everywhere as "GLAX", a word suggesting glass with a difference: strength. And visually, the "ss"-replacing-"x" even suggests the dual composition involved. Glax is a generic term like steel or wool and even has its own generic logo, a symbol for public recognition and promotion.

You'll see in the logo symbol an allusion the Moon. For the ulterior motive inspiring the people behind the successful Glax entry into Earth markets was the need to predevelop a technology suited for early lunar bases and settlements. Glax will provide a relatively

MMM Theme Issues: The Lunar Economy - Years 1-25 Dec 1986 - Nov 2011

inexpensive, uncomplicated industry for the settlers both to furnish badly needed exports, and just as important, a whole range of domestic products that will help hold the line on imports. As such, Glax is an essential keystone in the plan to achieve economic viability and autonomy for the projected City.

There is a lot of enthusiasm on Earth now, not just for a lunar scientific outpost à la Antarctica, but for a genuine settlement. This change of attitude did not happen by accident, and the story of Glax on Earth played a major role in this turn of events. Glax, since the first door-opening day of Lunar Dawn Furniture Company, was aggressively marketed as an anticipatory lunar technology. The public began to get the idea that moon dust might be good for something and that the idea of a self-supporting settlement relying largely on its own resources was not a flake notion, but rather something reasonable, even to be expected! Lunar Dawn helped the process along when after moving into its brand new plant in suburban Milwaukee, it built a simulated lunar home next door, soil-sheltered and all, with solar access, periscopic picture windows, ceramic, glass, and metal interior surfaces, and of course furnished with its own Glax furniture lines. The habitat was accessed by "pressurized walkway" from the meeting hall-display room-library-computer network room and gift shop built alongside and used free of charge by Milwaukee Lunar Reclamation Society.

How did this all happen? Notice the fine print on Lunar Dawn ads and billboards (also used in connection with other Glax product companies): it reads "An Ulterior Ventures Company". Ulterior Ventures isn't some big conglomerate but a unique venture fund which the National Space Society helped to organize to give entrepreneurs willing to predevelop anticipated lunar technologies for Earth markets, a little help to get started. Successful members of the Ulterior Ventures family pay a royalty which helps build the fund for even more ambitious exploits. In future articles we hope to tell you about other successful -- if not so well known -- members of the Ulterior Ventures family.

Future Fact or Science Fiction?

Fiction? Yes. Unrestrained flight of fancy? No! This is the sort of thing that could happen with NSS encouragement, if the society can be persuaded to show the same enthusiasm for direct action as it always has for indirect agitation "to make it happen". Having to start from scratch to build the infrastructure to incubate and support such "ulterior ventures" would mean an unwelcome set-back in time, effort, and personal energies.

The brand new infant industry sketched above does not require expertise in preexisting sophisticated technologies to get started. Almost any of use could get in on the ground floor of such an endeavor in one or more capacities. Any takers? -- Peter Kokh May 1988

MMM # 18 September 1988

A Strategy For Following Up Lunar Soil-Processing With Industrial

M.U.S.-c.l.e.

MUS/cle by Peter Kokh

How can a small settlement (anything less than some hundred of thousands and probably a whole lot smaller) have the most effect industrially? Some "muscle"? Fortunately, we have a clear and precise criterion by which to judge, and it points the way like a beacon: keeping support tonnage from Earth to a minimum, i.e. making do for as much (mass-wise) of the settlement's needs as possible from local lunar resources. To strive in this direction, the settlement -- while not neglecting any possibilities -- will do well to give top priority to items

MMM Theme Issues: The Lunar Economy - Years 1-25 Dec 1986 - Nov 2011

which, multiplying unit weights by quantity needed, embody the greatest opportunity for savings if manufactured locally.

Among equally weighty categories, those items that require less industrial sophistication and diversification and which are not unreasonably labor intensive would naturally get first attention (e.g. one ton of dishes over one ton of electronics).

Shelter itself, with some parts of utility systems (e.g. pipe and conduit at least), and basic furniture and furnishings made of 'lunacrete', iron and steel, ceramics, glass, fiberglass, and glass-glass composites (glax) are obvious items on the list. Such things should account for most of the settlement's physical plant.

What about sophisticated products: machinery of all sorts, vehicles, electronics, appliances? Too ambitious? Only for the unresourceful. Consider that every supposedly more involved product is an assembly of parts that often includes a shell, casing, cabinet, body, hull, table, etc. that is less complex and yet often represents a considerable part of the total weight of the item. If such parts were made in the settlement and final assembly done there (the really complicated and sophisticated portions representing the output of any subcontractors being preassembled on Earth in subassemblies as large and as integral as possible) this would hold down the principally weight-determined support price of everything from major shop tools to telephones to vehicles.

This would mean standardizing the size and interfaces of supported subassemblies, cartridges, chases, etc. to fit the very minimal number of cabinet, casing, and body models, etc. that the small lunar work force could produce. (If the completed item were supported, parts supply would be the only limiting factor on variety). Even so, "standard" cabinets and casings could be made to take varied finishes, textures, and colors.

Now the way we make many items on Earth, especially electronics, would lend itself to this approach. Of course, a central office (on Earth would save lunar manpower from paperwork) would have to coordinate everything, so that only chases and work-trays, etc. that would fit made-on-Luna casings and cabinets would be supported. This should not be hard to arrange on a bid basis.

The weight savings on major appliances in cases in which the settlement is not yet prepared to make more than the housing should be considerable. Many such items could be redesigned so all the sophisticated "works" are in one or a few slip-in cartridges.

By the way, all this reasoning holds just as true if it turns out that the first off-Earth settlements are in free space colonies rather than on the lunar surface. Such settlers would operate under the same restrictions until their numbers are vast enough to support self-manufacture of all their needs. They too will need the right strategy to build industrial "muscle".

Why not vehicles (both surface and intra-biosphere) with the body or coach made on the Moon, designed for easy retrofit of a cartridge-like wiring harness, control panel / dash, and motor (even here major heavy parts could be locally made and designed for ease of final assembly)? The benefits of such a setup would be immense.

To maximize the possibilities for "lunar content" and the ease of final local assembly will require designing such vehicles from scratch with this very goal as utmost priority. In a future article, we will talk about the need for an agency to take the initiative in stockpiling such "cartridge designs" for future lunar need.

Keep in mind that lunar surface vehicles are vacuum-worthy spaceships. So the next step would be Earth-Moon, or rather LEO, low-Earth-orbit to Moon or lunar orbiting depot) ferries of high lunar content (cabin, hold, tankage, etc.) and then even space station modules for LEO and GEO designed for easy snap-in outfit-ting of "works" from Earth.

"M.U.S.-c.l.c." a 2-part Acronym

You will have noticed the unusual way we spelled "muscle." For our strategy calls for the: **M.U.S. (Massive, Unitary, Simple)** parts to be made by the settlement and the

MMM Theme Issues: The Lunar Economy - Years 1-25 Dec 1986 - Nov 2011

C.L.E. (Complex, Lightweight, Electronic) components to be made on Earth to support up the gravity well and be mating on the Moon (or early space colony).

Here then is the logical formula for giving industrial muscle to the early settlement still too small to diversify into a maze of subcontracting establishments. It is a path that has been trod before. It plays on the strengths of the lunar situation and relies on the early basic industries: lunacrete, iron-steel, ceramic, and glass-glass composites (glax).

And not surprisingly, it is the path of lunar development that will produce the most in exports to LEO, GEO, L5 (?), and even Mars.

Importance of the M.U.S.-c.l.e. Plan for the Opening of Mars

Yes, Mars. That strangely romantic, sirenic world that so many are so impatient to get to just once even at the cost of perhaps never being able to return. It is possible to go direct to Mars from an LEO depot around Earth. The plan would send humans and cargo not needed till later separately. But if it is worth going to at all, it is worth having every advantage in our favor, including the capacity -- for the same total fuel cost -- of sending enough equipment to make a prolonged, even permanent stay possible as well as making follow-up trips economical enough to withstand the inevitable public loss of interest when they find out just how hostile a place Mars really is: that Mars isn't Barsoom, after all!

Using Made-on-Luna "M.U.S." Components to lower the cost of Missions to Mars

Back to our Mars expedition. Think of the weight savings if only the basic core crew cabin (let the crew put up with the sardine-packing of "steerage" for the short trip out to the Moon on the shoulder of Earth's gravity well) and "C.L.E." cargo had to be boosted up from LEO. More spacious quarters in shell form (M.U.S.) and even the hulls of the Mars landers themselves could be added on at the lunar staging port (probably at the L1 Lagrangian point some 36,000 miles Earthward from the Moon). The crew would be highly motivated by the need for more space and could complete the assembly during the months-long journey out to the Red Planet. Give 'em something to do. The fuel savings would translate into more total cargo and, consequently, a much enhanced chance of success on Mars.

After the Mars Frontier is "Opened"

If Mars were truly opened up for settlement, and it is in the Moon's interest that it should be developed as an alternative trading partner to Earth, then until Martian industry developed its own "muscle", there will be a strong market on Mars for made-on-Luna vehicle bodies and hulls, ready-made and portable shelters, and other items. It will be far less expensive for the new Martians to import items co-manufactured on Luna as opposed to those wholly made on Earth. Without this advantage, the Martian settlement effort will last only slightly longer than a snowball on Venus.

The Further Contribution a Phobos-Deimos M.U.S.-c.l.e. Plan Could Make to Mars

Here we think of those items not needed by a Mars expedition until arrival in Mars orbit: aerobrake shields, parachutes, and landing skids / skis. This is in addition to fuel needed for descent and final braking. Ph.D. (Phobos/Deimos) could also make solar panels for Mars-orbiting communications satellites brought from Earth, etc.

By leveraging each new foothold in space on the one before, we can go far! PK

MMM # 22 February 1989

1st EXPORT\$

A 1988 SSI Brainstorming Workshop

FIRST EXPORTS Reported by Peter Kokh

MMM Theme Issues: The Lunar Economy - Years 1-25 Dec 1986 - Nov 2011

The Team

In MMM #20 "STATION MATE" we reported and commented on Space Studies Institute's 1988 brainstorming Lunar Systems Workshop session that addressed commercial and entrepreneurial opportunities in Low Earth Orbit (LEO). In this article we'd like to report on the work of another team at this same workshop, this one addressing Lunar Surface Operations. The team budded a "Quick Payback" Subgroup consisting of Edward Bock of General Dynamics, Gregg Maryniak and Rick Tumlinson of Space Studies Institute, Robert Temple of Pacific Institute, and Brian Tillotson of Space Resources Associates of Seattle. The group's goal was the same: 'to create one or more scenarios or business plans for the productive use of lunar materials', guided by the "philosophy that independent, profit-making space businesses could provide a robust, non-reversible course into space."

Goal: Identify Profitable Opportunities from robotic missions to the Moon

In particular, the Quick Payback Subgroup looked for openings for economic gain from early precursor missions prior to actual human return to the Moon and establishment of a Lunar Base. In this way, the path back to the Moon could be 'terraced' with economically justifiable steps that would both guarantee and hasten the ultimate goal of using lunar resources to build a space-based civilization.

The first product or export to be gained from precursor missions would be salable information. A three tier scenario was outlined in which the information product from one mission would help boot-strap the next mission.

Information from Teleoperated Rovers

The first mission would entail a one-way lunar lander with a ten [metric] tonne payload to include six small teleoperated rovers weighing four tonnes together, a two tonne pilot liquid oxygen production plant, three tonnes of avionics, and one tonne consisting of TV cameras and transmitter, a robot arm and hand, and a demonstration electrostatic or electromagnetic iron beneficiator.

The purpose of the teleoperated rovers is, of course, soil sampling and site investigation. But before they are deployed to their first target assignments, 'income could be earned by a teleoperated rover race' between individuals on Earth from companies that will have built them 'for free for the promotion value', or between teleoperators who will have bid on the rights to participate in this "race of the millennium".

This form of prior sale will cut the costs of such a mission to \$200 million about half of which would go to Energia-class heavy lift vehicle transportation. The camera equipped rovers could earn additional revenues by providing moving pans of lunar landscapes for movie productions and as backdrops for commercials, with a capacity for 'live' footage.

An Ambitious Soil Return Mission

Plus Liquid Oxygen Production

Plus production of glass & iron trinkets

The next mission would be more ambitious and include a 1.5 tonne sample return of lunar material [the sum total of Moon Rocks returned by the six Apollo missions was 841 lbs or .38 metric tonnes] and also a 2nd generation liquid oxygen production plant with the capacity to process small amounts of lunar glass and iron [included in the lunar soil run through the plant] "into high value products for sale on Earth, such as lunar iron 'coins' and lunar glass 'jewelry'".

The value of such products on a back-home market is highly speculative and depends almost entirely on demand. The group optimistically hopes for a sustainable demand for such coins and jewelry in the \$300-500 per carat range. [By way of comparison, this is over 100 times higher than the going rates for gold or platinum. But a check with a local jeweler gives the current (2/'89) price range for diamonds as \$1800 to \$100,000 per carat depending on quality.]

MMM Theme Issues: The Lunar Economy - Years 1-25 Dec 1986 - Nov 2011

This second mission would likewise deliver 10 tonnes to the Moon, but this time, half of that would consist of the sample return rocket. If the target \$500/carats yield is realized, the mission would earn a tidy \$750 million against its cost of \$200 M.

The third mission would bring up a 3rd generation LOX plant, return fuel and an aerobrake equipped rocket. The mission's purpose would be to demonstrate the profitable return to LEO of a sizable 8 tonne payload consisting of LOX (liquid oxygen rocket fuel) and more made-on-Luna trinkets, with up to \$1.4 billion profit at a now slumping \$200/carats.

While the payback figures hoped for remain highly speculative, the study does give much encouragement to the expectation that Lunar EXPORT\$ can commence prior to human return.

**[Cf. FIRST STEPS TO LUNAR MANUFACTURING: RESULTS OF THE 1988 SPACE STUDIES INSTITUTE LUNAR SYSTEMS WORKSHOP by Gregg E. Maryniak, Executive Vice-President of Space Studies Institute. The complete report is available for \$10 from SSI, P.O. Box 82, Princeton, NJ 08542.]

Note: the above contact information is no longer valid

MMM

What is needed is not a one-time sprint to a nearby planet,
But a slow, patient expansion away from Earth,
A long-term program, perhaps taking a century to complete. –
That would equip us not just for a single interplanetary joy ride
for the coordinated exploration of the deep solar system.
– Isaac Asimov

No grimmer fate can be imagined than that of humans, possessed of godlike powers,
confined to one single fragile world. – Kraft Ehrlicke

MMM # 23 March 1989

HELIUM 3

HELIUM 3 By Eric Ryden, Chicago Space Frontier L5

The January 1989 issue of Fusion Technology contains a report of the 1988 NASA Lunar Helium-3/Fusion Power Workshop. The meeting addressed the potential of mining helium-3 (^3He) from lunar regolith for use on Earth in fusion energy, assuming practical ^3He use around 2015. Researchers at the University of Wisconsin-Madison had proposed lunar ^3He mining¹, based on previous analysis of lunar soil samples that showed that the Moon serves as a collector of helium deposited by solar winds. Natural ^3He is scarce on Earth. The workshop assessed fusion energy methods and approaches for lunar surveying, mining, processing, storage, transportation, and facilities required for recovery.

Fusion involves the combination of light element atoms into heavier atoms to produce energy. [Ed. Fusion creation of atoms lighter than iron producing energy, of elements heavier than iron consuming energy.] In comparing deuterium-tritium fusion which uses two isotopes of hydrogen, with deuterium- ^3He fusion, the latter was considered to produce less radioactive wastes and higher electricity conversion efficiency, but would be more difficult to ignite and contain.

MMM Theme Issues: The Lunar Economy - Years 1-25 Dec 1986 - Nov 2011

Analysis of lunar regolith showed that higher titanium dioxide (TiO₂) levels correspond to higher ³He levels, a relationship which could not be explained. Distribution of TiO₂ might be made by remote sensing to infer ³He distribution, since ³He cannot be directly detected. [Ed. Higher titanium concentrations are found principally in some mare basalts. We may also want to map high-titanium basalt distribution in the maria to locate the best concentrations of ilmenite, an iron-titanium ore whose processing would produce liquid oxygen.]

Most ³He is concentrated in regolith [fines] smaller than 50 micrometers, thus screening and sorting collected material for this portion is desired. Following processing, separated helium would require isotope distillation to obtain ³He from the more prevalent ⁴He. Isotope distillation could be performed on the Moon or after transport to Earth [Ed. involving a severe weight penalty for the included unsalable ⁴He].

Lunar oxygen production from ilmenite (FeTiO₃) after 2000 could demonstrate lunar mining and processing, as well as generating metals and small amounts of ³He as byproducts. However, this process is not efficient for ³He production because most helium would be lost in the concentration of FeTiO₃ from regolith. Alternatively, heating regolith for ³He production also creates volatiles such as water, which could be utilized for other lunar activities. Thus the existence of either a lunar base or a ³He production facility could affect the planning and development of the other.

Further details of the workshop are contained in NASA Conference Publication 10018. I Wittenberg, L.J., Santarius, J.F., and Kulcinski, G.L, "Lunar Source of ³He for Commercial Fusion Power. Fusion Technology 10:167-178, 1968.

ER

GAS SCAVENGER

GAS SCAVENGER

Waste-not, Want-not: Available Byproducts of Soil Moving

By Peter Kokh, based on these sources:

1 Lunar & Planetary Institute, Houston and Research School of Earth Sciences, Australian National Univ., Canberra. pp.147-169.

2 "Water and Cheese from the Lunar Desert: Abundances and Accessibility of H, N, and C on the Moon" by Larry A. Haskin, Dept. of Earth and Planetary Sciences and McDonnell Center for the Space Sciences, Washington Univ., St. Louis, MO.

The powder-like dust of the lunar surface is a housekeeping scourge. But this same fine grain texture carries with it a fringe benefit that more than makes up for any nuisance factor. It was one of the biggest surprises of the Apollo Moon Rock studies to find that this pulverized soil had been acting like a sponge soaking up the solar wind for four thousand million years. While the lunar rocks and soils themselves are extremely dry and deficient in volatile elements (those which melt and vaporize at relatively low temperatures) there are plenty of these elements both adsorbed to fine grains and trapped in minute cavities and pockets within soil particles.

Particles from the solar wind, from solar flares, and from cosmic rays, each leave characteristic traces and from these it is clear that the solar wind has been the main source of the volatiles we now find. Other sources include volcanic fire-fountains or fumaroles and meteoritic or cometary bombardment¹. By all these means, the upper meters of the lunar surface has become effectively saturated. A lunar form of fossil sunshine if you will.

Travelers in the Wind

MMM Theme Issues: The Lunar Economy - Years 1-25 Dec 1986 - Nov 2011

Foremost of these guest elements is hydrogen – protons comprise 90% of the solar wind – followed by Helium – alpha particles comprising 10% of the solar wind¹. While no hydrogen has yet been found in lunar rocks proper that gives any indication of being native and while no water or water-ice has yet been found [as of 3/'89, eight years before the Lunar Prospector mission], the amount of adsorbed hydrogen is far from negligible.

It is now estimated that there is enough hydrogen in one cubic meter of lunar topsoil to yield, combined with lunar oxygen more than a pint and a half of water.

Extending this figure to the Moon at large, the total global regolith layer, if it could be harvested 100% for hydrogen, could yield a lake of water 10 km wide x 68 km long by 100 meters deep (roughly 6x40 miles by 330 ft. deep).² While this is hardly an ocean full it is a surprising amount all the same. The real question is whether this endowment can be harvested economically.

Carbon and nitrogen, which are found as traces in the rock (30 and 1 parts per million respectively) are enriched in the regolith soil to 115 and 82 ppm (kg per thousand metric tons).¹ Another way of putting this is that an area mined 6m long x 6m wide and 1m deep contains as much nitrogen as an average human body. Or consider that the amount of carbon locked up in soil organisms on Earth is only 2.7 times the amount of carbon adsorbed to the same amount of moon dust. It's just there in a totally different form than we are used to finding and harvesting it. We need new methods, new tools, a new way of living off the land.

In Earthside laboratories, gasses trapped in lunar soil samples have been released by simple heating. Some gasses will need more heating to scavenge, others less. Further pulverizing may be needed to release compressed gasses trapped in glass cavities and vugs (small, irregular-shaped, rough, crystal-walled cavities inside rocks) at pressures commonly as high as five thousand atmospheres! Laboratory methods are one thing. Engineering the equipment to do the job economically on a large scale in routine fashion is another. Here is a hardware R&D job as ultimately important as any.

While it may be true that extracting the H, C, and N in a finite amount of lunar soil could provide for all the needs of an appreciable biosphere², the first milestone might well be the ability to make up for all leakage losses with the gasses extracted from the soil in the everyday 'lith-moving involved in building roads, excavating shelters, covering new habitats with shielding etc. As this would mean that all imported H, C, and N could go towards increasing the size of the biosphere, it would be a major step on the road to self-reliance.

What we are suggesting then is that any piece of regolith-moving equipment involved in constructing the various parts of the base/settlement-to-be or providing the various processing plants with ores should routinely process all the soil it handles to harvest the gasses trapped in the soil.

This capability should be built-in. On page twelve of this issue, there is a sketch by Pat Rawlings (Eagle Engineering) of a mobile soil harvester in the service of the liquid oxygen industry. This sketch appears in Ben Bova's 1988 book *Welcome to Moonbase*. In our view, such a machine should never be built as depicted. Scavenging soil gasses (not including the oxygen chemically combined in soil minerals, at c. 45% by weight) must not be an afterthought, an accessory to be added later, a luxury to be built into future models.

Scavenging soil gasses will be an exercise in self-endowment and the settlement that does not practice it de rigueur will not deserve to succeed. Gasses harvested in excess of current need will become a capital investment in the settlement's future. A lunar community that practices such gas scavenging will have a friendlier more at-ease attitude to its adopted world than one which, not doing so, chooses by default to remain a stranger in a strange land.

It's hard to say what a proper gas scavenging soil mover would look like. A lot depends on whether or not it is practical to do at least a first sort of the different gasses into separate tanks on the spot, possibly attached to sequential heating chambers, or whether this task is best done in a fixed plant. If the gasses can be stored compressed, the soil mover can do more

MMM Theme Issues: The Lunar Economy - Years 1-25 Dec 1986 - Nov 2011

work before unloading full tanks and taking on empties. Is anyone working on such a gadgetmobile? We would be surprised.

The Noble Gases

As to the noble gasses (chemically inert, not reactive with other elements) each cubic meter of 'lith contains an average 20 grams of Helium, 2 each of Neon and Argon, 1 of Krypton, and a milligram of Xenon. The extent to which these gasses can be economically extracted from the soil may well determine which form of lighting bulbs and tubes it will be most feasible to manufacture on the Moon using the highest possible 'lunar content'.

Will neon lighting, presently undergoing a tremendous renaissance in this country, play a major role in illuminating as well as decorating lunar habitats? As soon as a settlement reaches a certain viable size it will pay for it to provide for its lighting needs by self-manufacture so this question is not an idle one.

The Implications

There are strong implications in all this for lunar city-planning. Contrary to the usual vision of lunar settlements in which personnel are limited to cramped quarters sardine-style, our future lunar sodbusters engaged in routine gas scavenging may find it profitable to construct more square footage of habitat and more footage of pressurized passages and roadways per person. As avoiding cabin fever will be harder than on Earth, this may be the only way to sustain general mental health and morale. Lower density living brings with it lessened vulnerability to impact damage, and a larger biosphere mass per inhabitant i.e. "MM Manifesto!"

MMM

MMM # 32 February 1990

[The following article was published as part of the Milwaukee Lunar Reclamation Society's entry into the 1989 National Space Society's design competition for a Lunar Settlement in the 1,000-5,000 class, (runner-up entry)]

IMPORT / EXPORT EQUATION

IMPORT/EXPORT EQUATION

By Peter Kokh

To survive, a settlement must earn more in exports than it pays for imports

A. Settlement Import Categories And Strategies to Cut and/or Avoid Them

1. CAPITOL EQUIPMENT: "MUS/cle" co-manufacture is easily the most promising approach. A minimal sintered iron and glass composite manufacturing capacity must be imported first. Thereafter, complex lightweight electronics-rich ("cle") "works packages" from Earth are mated to Massive Unitary Simple ("MUS") parts made on the Moon of Lunar materials and assembled on the site to make additional equipment for Energy Generation, Mining & Processing, Manufacturing, Construction, Fabrication & Repair, and for Food Production. [cf.: "M.U.S./C.L.E." in MMM #18 September '88 pp. 10-11 above]

2-SETTLERS: "Bantamweights" will do. For Prinztown will be run with brains rather than brawn. Weight savings on settlers can be applied elsewhere.

3-FARM PLANTS AND ANIMALS: Seeds only, and worms and bee colonies; Seeds packed in hot pure N₂ to kill hitchhiking pests; Unpatented non-hybrid cultivars only; and pregnant female

MMM Theme Issues: The Lunar Economy - Years 1-25 Dec 1986 - Nov 2011

animals only.

4-VOLATILES: Hydrogen, Carbon, Nitrogen: The import burden can be softened by some careful measures faithfully pursued:

(a) Harvesting, by heating, of the significant quantities of H, C, N, and other gases adsorbed to the fine regolith particles, thanks to eons of bombardment by the Solar Wind, during all those construction processes involving soil moving;

(b) Out-sourcing to gravity wells more shallow than Earth's e.g. Phobos and Deimos, Earth-approaching asteroids and comets;

(c) Conservation of volatile-rich organic materials by religiously thorough recycling efforts. In support of this goal Prinztown will need "kosher" (organics not bonded to inorganics) knock-down-friendly ("KD") assembly methods; systematically thorough and foolproof sorting clues and handy routing managements; and above all the help of ingrained second-nature good habits and expected chore assignments.

(d) 'Pre-codesigning' of all single-use containers for volume-matched secondary more durable uses. (An example already attempted was the elusive "World Bottle" design i.e. a bottle that could be reused as a brick; Effort not yet successful.)

(e) Buttoning up pressurized areas for Nitrogen conservation by use of novel airlock systems: Matchlock "intergates" to allow suitless shirtsleeve transfer between vehicles and habitat areas; Liquid airlocks for some freight categories such as goods manufactured inside for use in vacuum and vice versa; and turtle-back spacesuits that back into special mated airlocks for direct entry from suit to habitat and vice versa.

5-RARE METALS: An elegant way to painlessly "co-import" rare metals, and even some synthetics is by making all needed shipping containers end packaging out of such materials i.e. the easily forgotten category of "Tare". [Gross - Net = Tare] Making this standard practice could provide a tidy "cheap" endowment of badly needed materials hard to process from the Lunar soil such as copper, brass, other precious metals, other needed alloying ingredients, and even some volatiles in the form of lightly polymerized synthetics. Crates, Boxes, Barrels, Tanks, Cans, Bottles, and packing stuffing and dividers could all be made of such strategic materials.

6-HABITATS: To make the Prinztown construction camp, an original minimum number of tight-packed space station module type sardine cans can be followed by locally manufactured and constructed Big Dumb Volume Structures in which are placed "Works Core Modules" made on Earth. Such cores would contain Kitchen/Bath facility, electrical service, communications-entertainment center, air conditioning-heating-leaning unit, etcetera. The total core package would be lighter (no massive hull) and cheaper to support from Earth and the host habitat would be much more spacious and cabin-fever resistant. Such Works Core Modules, but with an ever greater Made-on-Luna "MUS/cle" content, also serves in Prinztown's Village Homes.

7-NON SELF-MANUFACTURED GOODS: For those needed and desired items Prinztownians need but are not yet capable of providing for themselves, the "MUS/cle" formula is again part of the answer. But substituting metal, glass, Glax* [composites], and ceramics wherever possible for wood and plastics, and doing without wherever this is impractical must be Plan A. Mail order catalogs from Earth will be taboo and instead items from the hands of local artists and craftsmen will be treasured. A paperless all-electronic society will be a top priority goal. [cf: "Paper Chase," MMM # 4 April 1987, republished in MMMC #1.]

B-Strategies to Lower Import Costs and/or Increase Import Quantities

1-ALTERNATE SOURCES: Prinztown will need to import considerable quantities of hydrogen, carbon and nitrogen, most easily handled in the form of methane CH₄ and ammonia NH₃. Discounting the amortizable capital costs of emplacing the needed equipment, these volatiles can be shipped at a fraction of the total fuel cost, from Phobos or Deimos, moons of Mars, at regular 26 month intervals. Such shallower gravity well sources also include occasional catch-as-catch-can Earth-approaching asteroids, comets, and wildcat-worthy inactive comet-hulks. The Moon's deficiency is the Solar System's gain. For settlers will have a do-or-die urgency in pioneering such markets.

MMM Theme Issues: The Lunar Economy - Years 1-25 Dec 1986 - Nov 2011

2-LOWERING COST-OFF-EARTH will be above all a matter of developing (at last!) more economical surface-to-orbit launch systems. But our crafty settlers will also attempt to lower prices FOB Earth by buying goods on favorable terms Solar Power Satellite customer nations.

3-LOWERING COST-ONTO-MOON. Unlike both Earth and Mars, the Moon has no handy atmosphere to allow aerobrake assistance. But there are other more inventive alternatives to full retrobraking. These may include skid-landing on prepared regolith smoothways. [Lunar Bases and Space Activities of the 21st Century, W.W. Mendell Ed.r, Lunar & Planetary Institute, Houston 1985 pp. 848-50 "The Lunar Slide Lander" by Kraft A. Ehricke] and the "Edportation" scheme of inventor Ed Marwick. Passengers may not line up for such wild rides, but drone "sliders" could bring in needed bulk materials and other hardy cargoes.

C-LUNAR EXPORT CATEGORIES

1-BULK MATERIALS: Liquid Oxygen; Regolith for shielding; Enriched ores for space processing.

2-OXYGEN CONTAINING PRODUCTS such as Water and Foodstuffs cheaper than from Earth even if they contain terrestrial Hydrogen and Carbon.

3-BUILDING MATERIALS AND COMPONENTS: Iron and Steel; Aluminum, Titanium, Magnesium alloy; Glass and Glass-Glass Composites; Ceramics & Concrete.

4-ITEMS MANUFACTURED ON THE MOON to cut imports are also marketable to LEO, GEO, L5, Mars Ph/D (Phobos, Deimos): Furniture and furnishings; Tanks, Holds, Appliance Cases, other items.

D-EXPORT DESTINATIONS

Low Earth orbit Space Stations and other manned facilities, Space Colony Oases at L4/L5 or in other orbits, and Mars-bound expeditions are all Markets for Lunar Lox, Food, Water, building materials products, and sundry finished goods all Lunar or MUS/cle assembly). Geosynchronous orbit is a destination for large multi-satellite capacity platforms and Solar Power Satellites.

E-STRATEGIES TO INCREASE EXPORTS

1-LOWERING EXPORT LAUNCH & DELIVERY COSTS:

Mass Drivers, Bucket, and Pods should be upgraded to launch more profitable value-added goods.. 1st Upgrade: enriched beneficiated ores: Fe, FeO, TiO, Al₂O₃, CaO, MgO, SiO; Batch-loads of glass matrix, glass fiber, and cement. Second Upgrade: right-sized ingots: Fe, Al, Ti, Mg. 3rd Upgrade: shock-proofed pods of small manufactured parts. In addition, goods bound for Earth's surface could be shipped in no-transfer self-contained Earth-aerobrake-and-Land "dynasoar" capsules.

2-INCREASING MARKET DEMAND: Liquid Oxygen: Would-be-Prinztonians should push development of "Stage Plus" Earth Deep-Space Launchers designed for on-orbit LOX refueling. Food deliveries to LEO stations and other space locales, will depend on selection, delivery, marketing.

Building Materials: Lunar-owned Space Architecture and Space Construction Firms will channel a greater share of space construction profits back to the Settlement. Promotion of 1/6th G lunar Gravity as a Standard for rotating space structures will mean quicker, more frequent sales because the rotation rate linked minimum size and mass of such oases will be a magnitude smaller, a more attainable threshold.

Prinzton made Consumer Goods can be promoted along with Lunar-type material culture in general as the appropriate norm for near Earth facilities in the era of still expensive volatiles. Such goods involve material substitutions and a high profile for Art/Craft made wares.

Promotion of the Moon as the "Hub" of the ETM (extraterrestrial materials) economy will be an essential settler policy. Their do-or-die motivation and proven knowhow will drive Lunar-initiated market development of Mars and its moons, and of the Asteroids. Key here may be the development of Minimal Mobile Biospheres. The larger deep-space long-cruising vessels have to be to hold self-contained mini-biospheres, the greater the obstacle to opening the asteroids.

3-MARKET TARGETING: Logical Earth Trading Partners for Prinzton are those nations which are at once • Energy Importing Countries (Solar Power Satellite sales, Helium-3 sales) and •

MMM Theme Issues: The Lunar Economy - Years 1-25 Dec 1986 - Nov 2011

Sources of elements not economically Lunar-sourceable yet strategic to Prinztion development. Many of these countries are in the "Urban Tropics."

4-MAXIMIZING TOURIST INCOME. The lure to well-heeled sightseers can be intensified in several ways.

A "**Seven Wonders**" list, carefully drawn up and publicized, and a variety of enticing itineraries will encourage repeat trips or at least longer stays.

Special ways to taste the settler way of life can be offered to visitors.

- Stays in lunar homes
- working tours
- Art & Craft classes
- special tours e.g. of factories and recycling systems, and
- the opportunity to actually participate in unique Lunan sports.

Customs regulations can entice tourists to trade all their Earth garb (for Lunar Stage/Theater Use) in exchange for souvenir Made-on-Luna apparel.

Shopping Spree Tours for unique arts, craft, and clothing pieces at the Settlements cottage industry flea markets should be marketed.

5-TELEVISION & FILM MEDIA SALES:

Advertising Revenues could be appreciable enough to wholly finance: • Development of Unique Lunan Spectator Sports, which in turn could be televised to Earth audiences hungry for something new and exotic.

- Construction of any facilities such sports may require
- The same goes for the "ethereal" Prinztion Ballet Company, probably awaiting the coming of age of the first native-born generation.
- Documentaries about Prinztion and Lunar activities at large will vie with space adventure films for the use of the Out Of This World film studio in Prinztion.

6-EXPORTING KNOW-HOW: Technology transfer is a potential money-maker for Prinztion. Hopefully much of the technology needed to make Prinztion a thriving reality will have been predeveloped for profitable terrestrial applications and thus served to keep Prinztion's up front costs far lower than they otherwise could be. But enterprising young Prinztionians will develop new products and processes salable Greenside. <MMM>



DIVERSIFICATION vs. SUBSIDIES

By Peter Kokh

+ EXPORTS	We have outlined a very ambitious
- IMPORTS	picture of what a mature
= BOTTOM LINE	Prinztion economy might look like.

But what is the logical order in which such a well-rounded economy might be best achieved? Diversification will in part depend on a number of things that we cannot accurately forecast at his time:

- **Size of the LEO market** for LOX, building materials, other manufactured goods
- **Progress in opening up space markets elsewhere**, e.g. Phobos/Deimos etc.

Different scenarios can be plotted assuming various values for these unknowns. But we can list

MMM Theme Issues: The Lunar Economy - Years 1-25 Dec 1986 - Nov 2011

some pertinent questions and their answers will greatly affect our strategy and game plan.

For each industry proposed for Prinztown, we will want to know the following:

- (1) What is the industry's capacity to **generate export tonnage**?
() Major - () Medium - () Minor
- (2) What is the industry's capacity to **defray import tonnage**?
() Major - () Medium - () Minor
- (3) What is the **export value-added** per tonne?
() Major - () Medium - () Minor
- (4) To what degree is the industry **labor intensive**?
() Major - () Medium - () Minor
- (5) To what degree is the industry **energy-intensive**?
() Major - () Medium - () Minor
- (6) What is the industry's **pressurized acreage need**?
() Major - () Medium - () Minor
- (7) How well can the industry's operations be separated into **successive** diurnal (dayspan) **energy-intensive** vs. nocturnal (nightspan) **labor-intensive portions**?
() Major - () Medium - () Minor
- (8) How much **heat** is **needed** for operation?
() Low - () Medium - () High
- (9) How much **heat** is **generated** by operation?
() Low - () Medium - () High
- (10) What is the industry's **need for vacuum**?
() Major - () Medium - () Minor
- (11) What percentage of **chemical reagents** used can be **recycled**?
() Major - () Medium - () Minor
- (12 a) To what extent can the industry be **set up in modular units** so that production capacity can be easily increased as needed?
() Major - () Medium - () Minor
- (12 b) How high is the import tonnage of each module in terms of economic gains?
() Major - () Medium - () Minor
- (12 c) To what extent can **MUS/cle*** co-manufacturing savings be applied to additional modules needed? [* see the article from MMM #18 above pp. 10-11]
() Major - () Medium - () Minor
- (13) What **prior industrial material by-products** are presupposed?
() Major - () Medium - () Minor
- (14) What **prior processing capacities** are presupposed?
() Major - () Medium - () Minor
- (15) What subsequent industries are **enabled by new byproducts** generated?
() Many - () Few - () None
- (16) What subsequent industries are enabled by processing capacities offered?
() Many - () Few - () None
- (17) How "**ready-to-go**" is the technology for operation **in Lunar Conditions**?
() Little - () Partly - () Go!

<p>Once we've done our homework on these and similarly relevant questions, we will be ready to begin a serious discussion of long-term Lunar Industrialization Plans</p>

"Not In My Back Yard" - "N.I.M.B.Y."

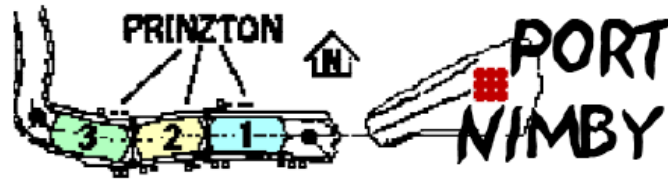

IMPORT/EXPORT SLEEPER Gross Imports that Could Count as Net Exports

Peter Kokh and David A. Dunlop

IMPORTING FOR DIRECT PROFITS

This may seem like a Cinderella idea. Prinztown already works toward over-all net profits by putting major emphasis on importing capital equipment to help both lessen the need of further imports and increase exports by enabling ever more local processing and manufacturing MUS/cle (see the article from MMM #18 in MMMC2, pp. 34-35) and co-importation by clever choice of tare materials. (see previous article "Diversification/Subsidies")

Every Trade Czar's fairy tale dream, however, is to be paid for the imports one's people need, rather than paying for them. Simply put, this means agreeing to take something unwanted-with-desperation off the hands (and minds) of some other bailiwick. Highly Toxic Chemical Wastes, Virulent Biological Wastes, Radioactive Wastes - might all fit this description.

"Not In My Back Yard" - "N.I.M.B.Y." is the classic universal reaction to these leprous by-products of today's advanced technology. In recent years, the unwelcome reality that every where on Earth is someone's back yard, is slowly sinking into the public consciousness. Governments continue to search for cost-effective-yet-safe ways to store or neutralize such techno-feces but it seems to be a hopelessly intractable problem. Promising solutions emerge only to be found fraught with fatal flaws.

Perhaps we need only be patient and elegantly "safe-yet-cheap" solutions will present themselves. But perhaps not. Meanwhile, problem wastes will keep on accumulating at an alarming rate so long as we do not wish to face the fact that those desirable materials that involve such byproducts may not be worth the ultimate cost.

Space to the Rescue? Ahah! You say. "Space to the rescue!" Several space-involving solutions to this runaway problem have been proposed.

(a) Let's move the offensive Chemical Processing and Biological Engineering Plants to LEO, low Earth orbit, where wastes can be dumped harmlessly in space. Alas, we are now learning, LEO is a very temporary place and everything parked there will eventually find a way back into the atmosphere. We must go well out, beyond the Van Allen Belts, to a realm ruled by the Solar Wind rather than by tenuous tentacles of our atmosphere. GEO, the Earth-synchronous orbit that is home to most communications and weather satellites, will do, as will the L4/L5 Earth-Moon libration points, or high-perigee Earth-Moon resonant orbits. The Solar Wind would carry offensive exhausts well beyond the outermost planets. (Heliopause smog?)

(b) "Dump the stuff into the Sun" seems the ultimate solution to those blissfully unmindful of common orbital mechanics facts-of-life. Of all space solutions proposed this is surely the most outrageously expensive in "Delta V" i.e. fuel expenditure requirements. First our skull-and-crossbones payload must be accelerated to some 25,000 mph just to reach the shoulder of Earth's gravity well. Then it must shed All of Earth's forward orbital speed, another 66,000 mph worth of velocity change. A short burn, short by any amount, would result in a highly elliptical orbit, bringing our "Flying Dutchman" alternately in towards the Sun and back out to Earth's orbit. In contrast, it would be far cheaper, in terms of fuel cost, to catapult this dreaded stuff in the other direction, out of the Solar System altogether. Another cheaper possibility would be to shoot for the all-engulfing depths of mighty Jupiter, as we hope to do with part of the Galileo probe in December, 1995.

MMM Theme Issues: The Lunar Economy - Years 1-25 Dec 1986 - Nov 2011

(c) **Expel it from the Solar System.** An even less expensive option than feeding the Sun, Jupiter, or the interstellar dust and gas clouds, is available to some future Dreaded Wastes Authority. We could rocket our nasty stuff into simple Solar Orbit, tele-open the canisters, and let the Solar Wind provide the Delta V, gently but inexorably blowing the stuff out of the System.

"One person's trash is another person's treasure"

Back to the drawing board

But all of the above suggestions choose to ignore the bit of wisdom that "one person's trash is another person's treasure".

All three of the problem waste categories we are discussing, are problems because of the over-context of Earth's Active Geology and Encompassing Biosphere.

This given geo-context renders inherently dangerous any and all methods of value recovery by incineration, distillation, electrolysis, precipitation, or whatever. Take the stuff out of this context and the entire situation has changed.

Toxicity = toxicity to something

Absent one of the two terms (biosphere) and it becomes totally illegitimate to continue to call the substances in question "toxic". Now, in this changed situation, we can talk possibilities fruitfully!

The next step is to determine where these troublesome wastes might have salvage value. You guessed it! – to settlers on our volatiles-impoverished Moon! To illustrate the potential of this Lunar Solution, we included Port Nimby on the periphery of the Prinztown Settlement Site. [see map hint in title art above.]

However, our settlers could afford to pay to import such tainted volatile-rich (hydrogen, carbon, nitrogen plus extras) shipments only if they were subsidized by desperate terrestrial authorities to the point that they would be markedly cheaper than the alternative Phobos-Moon "pipeline", with the much greater cost and difficulty of clean processing of the NIMBY hot stuff. Of course, if the shipments were free, F.O.B. Port Nimby, that would be ideal. That is unlikely, however, as one could expect custodial authorities on Earth to foot the bill to toss the stuff out of Earth's gravity-well but not the additional cost of soft-landing it on the Moon. Free "F.O.B. L1", on the crest between the Earth's and the Moon's gravity wells, is about all our settlers can realistically expect.

The biosphere discontinuity (the extremely hard vacuum and the total absence of ground water) between Prinztown and Port Nimby is what makes such an option many orders of magnitude safer than the most ideal of storage-on-Earth schemes.

Storage in lava tube sections, which have to date survived intact for nearly four billion years, leaves no rational basis for qualms of informed conscience. This is not case of disrespect for the Moon, anymore than it would be for the Sun. Again, toxics are not disrespectful to the Earth geologically considered, but only biologically considered. That is, they disrespect Gaia (the new name for Earth's biosphere) not Earth itself. In contrast the Moon has no biosphere whatsoever, and the totally encapsulated minibiospheres that we will establish there, can be easily kept rigorously isolated.

What's in it for the Settlement?

Much of the salvage processing of these "profitable imports" could be done robotically and/or by teleoperation from the safety of isolated bunkers.

The prizes to be gained are recovered **water** and **carbon dioxide**, and possibly **organic feedstocks** for production of those synthetics for which the settlers are not able to make inorganic substitutes, or reasonably do without

They might also "mine" the ash for **heavy and precious metals**.

Special "designer" bacteria might be of help in the process, though the sheer variety and probable careless premixing of wastes Earthside would tend to make this impractical as a

MMM Theme Issues: The Lunar Economy - Years 1-25 Dec 1986 - Nov 2011

general approach. It is possible, of course, that we will develop safe methods of detoxifying such wastes on Earth and/or quit producing them in the first place.

The point may never be reached where the lunar solution becomes economically attractive. A lot depends on when and if transport costs come down substantially.

Radioactive Wastes

What about Highly Radioactive Wastes? This is a considerably more stubborn problem. No storage site on the geologically active Earth can be safe for the full length of time needed, excepting possibly the deep-injection of such "hot" wastes into active subduction zones, for example where the Pacific plate is slowly diving under the advancing North and South American continental plates. By the time, if ever, such dumpings reemerged up some volcanic throat after tens or hundreds of millions of years of mixing with molten magma deep below the crust, no problem would remain. If that solution remains an impractical dream, then the intractability of the problem could make the lunar option very attractive.

Mining Radioactive materials for power and water

But how would settlers put such shipments to use? Perhaps they could be densified by distillation into significantly hotter concentrations, useful for generating Nighttime Power. They would be reclassified from "fuel" to "waste" when the power density they support falls below a certain level economically useful for the competitive generating stations on Earth. Yet they might still yield economical power in the quite different lunar economic environment.

Any water in which these hot shipments are stored for shipment, once repurified, would be a very welcome free addition to the settlement reserves. Further, radioactive wastes might also come in very handy for maintaining thermal equilibrium for the settlement. And the temperatures generated might allow continued nighttime operations of some Industries using concentrated solar heat by day such as glass and ceramics production and other "lifeblood" enterprises.

There are a lot of ifs that we can not honestly resolve here in 1990. The realistic cost of disposing highly radioactive wastes safely beyond a reasonable doubt may be so great that a lunar solution will become attractive.

But then, even if "the economics" became "right", there will be a host of public misconceptions to overcome – including the absurd pseudo-physics behind the opening "catastrophe" of the first episode of the much-watched science-fiction TV series, "Space 1999" in which a runaway reaction in just such a lunar repository of Earth's radioactive wastes dislodges the Moon from its orbit around Earth, to wander through space endlessly, meeting a host of aliens along the way, of course.. But possibly such "wastes" will be the first "treasures" imported by some future Port "N.I.M.B.Y." on the Moon. < MMM >

MMM # 34 April 1990



RECYCLING By Peter Kokh

[This outline of materials-management systems appropriate for Space Frontier settlements ALSO addresses some persistent Earth-side problems.]

Recycling is an integral and essential aspect of our "tenancy" of whatever corner of the universe we occupy. It is custodial common sense. And if it is becoming sound economics here on Earth, it will be an absolutely vital cornerstone of economics on the Space Frontier.

ORGANIC & SYNTHETIC MATERIALS

MMM Theme Issues: The Lunar Economy - Years 1-25 Dec 1986 - Nov 2011

First we'll need to recycle organic and synthetic materials derived from such volatile elements as hydrogen, nitrogen, and carbon which will not exist in the all-surrounding abundance we are accustomed to on Earth, even after we are able to supplement the vanishingly meager lunar sources with supplies from volatile-rich asteroids and comets. This self-discipline will be indispensable for Lunar Settlement, and highly advised for Space Colonies in near-Earth space.

Keeping the ratio of native lunar vs. exotic imported content as low as possible will alone allow any chance for a favorable trade balance and economic self-reliance. Thus priority must be given to our food and clothing needs in using these precious elements. The purpose of such an effort is to provide the lowest Cost of living, by stretching the service life of any volatiles imported at great expense and by reserving them for uses for which there are no substitutes.

INORGANIC MATERIALS

Contrary to intuitive expectations, it will also be salutary to recycle processed inorganic materials since they embody considerable energy expense already invested in extracting and processing them from raw regolith soils. The more energy-intensive a refined material is, the more to be gained from recycling it. Proper pricing of virgin materials will guarantee this outcome.

Tailings also embody the energy investment of their by-production, and using them to make secondary building products would capitalize on this investment. [See "TAILINGS" MMM # 25 p. 5. May '89 – republished in MMM Classics #3] Even glass cullet and ceramic shards can be used e.g. embedded in glass matrix decorative panels covers, fronts, handles and knobs. In the case of inorganic materials the purpose of all this effort will first be to reduce total energy-generation requirements, a strongly economic motive. Secondly, it will help settlers to minimize the Acreage of surrounding moonscape that will need to be disturbed to maintain there a population of a given size, an aesthetic goal. This "discipline" will allow us to tread softly and caringly on the magnificent desolation of an adopted virgin world.

Our strategy for realizing this authentic way of life will have many subtargets. Appropriate product design, easy sortability, convenience, collection nodes, routing and route servicing, divi-sion of responsibility, supply versus demand volume-matching, entrepreneurial opportunities, youth and school involvement, contests, public discipline, tax incentives, and backup systems must all be given special attention.

RECYCLING – FOUR BASIC PATHWAYS

- (1) **REUSING** all refillable bottles and containers is the most obvious and most economic.
- (2) **RECASTING** by crushing, shredding, melting, and then recasting fresh items is another. We do this with paper, aluminum, and plastics for example. This method is greatly hampered by unnecessary cross-contamination with durably-bonded unlike materials. As for markets for recycled temporary-use items, building products/ furnishings best match supply.
- (3) **RETASKING** or use-reassignment is a greatly underutilized third avenue. Timid examples are jelly jars designed for long reuse as drinking glasses and butter dishes designed to be reused as refrigerator ware. There have been at least three abortive efforts to design what has been termed a "world bottle", a glass beverage bottle ingeniously shaped to serve anew as a brick or building block. That is one task worth taking up afresh! Designing smaller high-fashion glass bottles for infrequently sold items, such as medicines, fragrances spices, etc., with a female-threaded punt on the bottom to match the male-threaded neck would allow combining these into stylish decorator spindles for any number of imaginative uses.

Formulating packaging and packing materials to serve as craft stuffs for artists or even as fertilizer for gardeners is a promising possibility. In any such dual purpose design effort, it will be critically important to find reassignment uses with adequate demand-potential to match, and use up, the full volume of supply. Otherwise any such efforts will be but futile and distracting gestures.

- (4) **REPAIRING** is one avenue increasingly being abandoned because of high labor costs.

MMM Theme Issues: The Lunar Economy - Years 1-25 Dec 1986 - Nov 2011

Repair costs, however, could be greatly reduced by more careful product design with greatly increased attention to assembly sequences and methods that are take-apart-friendly.

The present quest for seamless sophistication in appearance is one of several sirens luring manufactures in just opposite direction.

To repairing, we might add **refinishing and totally fresh makeover**. Even where repair or refurbishing is impractical, if the item in question cannot be economically disassembled, then the sundry parts that would need separately recycling will end up being irretrievably trashed.

Only the adoption of design and manufacturing methods not now in favor will make all this viable. Lunar manufacturers will need to sing this new tune. And frontier settlements cannot in the long run afford to import Earth-made items not knock-down friendly. The extra cost of meeting these new requirements will be minor in comparison with Earth to Moon up-the-deep-gravity-well freight charges.

INSTITUTE FOR MOON-APPROPRIATE INDUSTRIAL DESIGN

No amount of recycling discipline on the part of our hardy pioneers will work without such a wholesale redesign of consumer goods. For this reason, we really do need to start now by establishing an Institute for Moon-appropriate Industrial Design. While aimed at meeting demanding frontier requirements, the very constrictiveness of this challenge should make such an Institute the prestige Alma Mater of choice for industrial design students the world over, regardless of whether they had any intentions of ever leaving their comparatively soft Earth lives behind.

INDUSTRIAL ENTERPRISES

The significant upfront role of industrial enterprises in creating a material culture in which much more extensive and thorough recycling is possible than in our current American experience, is not limited to proper product design. It should be the highest priority of Frontier Governments, to provide encouragement and incentives sufficient to ensure that the principal avenue of industrial diversification involve new enterprises wins the byproduct materials of those already in place. Again, this compounds the productivity of energy already spent.

Properly integrated industrial parks will involve suites of industries in an ecosystem of traded byproducts. In one highly successful entrepreneurial effort in Texas a few years ago, an enterprising computer buff went from plant to plant, asking for data and any unwanted supplies, scrap, and byproducts to put in his data bank. Within the first year, he was able to generate enough networking between sources of previously unadvertised supply and potential customers to take in a cool \$5 million for himself.

"With a good system, even those who do not care, will do the right thing. Without a good system, even those who do care, can't do the right thing."

Given goods that are separable, sortable, and economically recyclable, the consuming citizen will at last have an honest chance to do his/her part. But it is not enough to know what should be done. Both citizens and government must also realize that without proper organization, on several levels, it won't happen.

SORTING

"A place for everything and everything in its place" is not only an unbeatable philosophy for managing one's basement, attic, and closets. It also applies to the home and business recycling corners. Instantly identifiable bins or baskets must be conveniently arranged for every category to be sorted separately. There is no reason that home recycling centers have to look untidy, a hodgepodge of Rubber Maid baskets and paper bags. A top priority household product should be some sort of bin-susan or bin-rack setup. Why entrepreneurs aren't turning such things out here and now is beyond my comprehension.

On the Space Frontier we'll need a greater number of different bins than we do here, where the economy is only organized to take in paper, glass, aluminum and some plastics. [Milwaukee's Pollyanna Plastics is now negotiating with area recyclers to take all the vinyl bottles and (!) polystyrene foam packaging they can buy back from the public, in addition to

MMM Theme Issues: The Lunar Economy - Years 1-25 Dec 1986 - Nov 2011

PET and HDPE plastics.] Glass and glax*, ceramic shards, and the various metals; refillables and tradables, used cotton cloth, fiberglass fabrics, thermo-plastics, paper stuffs, dye stuffs, plus various compost categories all need separate bins.

A collection system with convenient nodes to see that all these items find their way back to the industries that can use them, is the next equally critical and indispensable element in the recycling triangle. Perhaps the electric delivery vans of the settlement could belong not to individual merchants but to materials circulation enterprises. They would pick up appropriate categories of disowned goods even as they deliver, a prerequisite for a license.

ALTERNATIVES AND OPTIONS

But there must be many alternative routings to make a system work. If containers and packages in which shoppers bring things home are designed to collapse or nest compactly, they could be reused conveniently. It might even be bad taste to leave home empty handed! Drop-off Centers could be conveniently central to each shopping area. Properly arranged and managed (a place for everything, remember?) they needn't be unsightly. Featuring lockers, public toilets, cafes, they could include floral gardens, stalls for artists and craftsmen, repair and makeover shops etc. And why not arts & crafts classes, street music, dress-up fashion and bauble shows, and even a "soap box" for those eager to share their concerns?

COTTAGE INDUSTRIES

"Scavenge and Trade" licenses could be given preferentially to those with cottage industries based on giving new life to cast-off materials and items. Art du Jour, serendipitous temporary sculptures made from collected items, could be a major draw. Such creations might feature those items and sort categories for which the supply exceeds demand in the hope of stimulating would-be entrepreneurs and artisans to discover fresh unsuspected possibilities in such over-available stuffs. Demonstration classes in art-crafts using recycled and discarded items would be in order.

In Space Frontier pioneer towns, "recycling" may finally 'come out of the Alley'

Farm-Mart Centers, wherever grocery shopping is done, should not only take in the appropriate refillable containers but also buy/sell sundry categories of compost and composting accessories such as paper stuffs (e.g. corn husks) and garden and kitchen scrap dye stuffs, bone, and fat could be handled separately from any compost that exceeds home garden needs.

Jailed inmates could do the heavy duty labor intensive disassembly work; pardons might be in order for those demonstrating their capacity to function as useful citizens by entrepreneurial development of markets for orphaned and high surplus sort categories clogging the network. Primary and Secondary School involvement will be crucial in making the system work. This is the subject of the next article. [see "The 4th R" just below]

ROLE OF THE UNIVERSITY

Finally, the frontier University has a role to play as orchestra leader. The University, not government bureaucracy, must assess how well the system is working, and develop needed improvements.

A University office would maintain the computerized current inventory of various depositories with a disciplined materials accounting system monitoring supply/demand imbalances, and circulation efficiency, assign identifying sortation logos and routings for new classes, and maintain updated guidelines on a utility cable channel (or website).

The University should supervise and assist entrepreneurial experimentation in its labs and shops to develop new materials and products that will take advantage of various kinds of discard stuffs that are in excess supply. As such it will be a principal incubator of new businesses and economic diversification.

The University's **Institute of Industrial Design** would work to find new ways to implement such philosophies as "whole sheet" scrap-less design of product/accessory combos, "kosher" assembly of unlike materials for later ease of separate recycling, "honest surfacing"

MMM Theme Issues: The Lunar Economy - Years 1-25 Dec 1986 - Nov 2011

that utilizes the design advantage and character of materials undisguised by surface treatments that make proper sorting identification anything but easy.

VOLUME REDUCTION STRATEGIES

Not only must we provide for proper sorting and routing of items to be recycled, we must take care that the system is not overwhelmed. Volume reduction strategies are in order.

In the USA, packaging materials constitute 40% of trash.

In MMM # 4 April '87 "PAPER CHASE" [republished pp. above] we pointed out that wood, paper, and plastics will be prohibitively expensive. This whole fascinating topic of how to service the diverse packaging, labeling, and even the advertising needs of the settlement with minimum reliance on precious volatile-rich materials, that should be reserved to increase the mass of the biosphere "flywheel", will be the subject of a separate article in a later issue of MMM.

SUMMING UP:

We must not allow either Lunar or Space Settlements to be "born addicted" to a technology and culture of abundance and waste. All those elements needed to make this ambitious program work must be developed beforehand, pretested and pre-debugged before lunar settlement begins.

It would be best if as much of this as is appropriate could even be ready to go for the first NASA/International Moon Base. Those of us interested in off-planet settlement must begin the cooperative addiction-treatment program that will enable such a propitious fresh start, as well as create spinoffs that will aid in Earth's own environmental struggles.

Beating this addiction, from which we all suffer, will require a "wartime" dedication and inventiveness. Only to the degree we succeed will we prove ourselves worthy citizens of Earth's con-solar hinterland. < MMM >

"The Environment" - whether on Earth or on the Moon.

It's a question of pay now, or pay much more, later.

MMM

THE FOURTH 'R'

THE FOURTH 'R' By Peter Kokh

Here on Earth, we imagine we can afford the luxury of continued general ignorance of the way our Biosphere works and what may be necessary to maintain its health. We allow our young people to drop out of school, and allow those who do complete their courses to graduate with empty heads. We assume Mother Earth will go on taking care of itself as it has from time immemorial. Those that want to worry - that's fine, let them do their thing. The rest of us - let's party!

In the miniature oases of life that Ecotects design, build, and seed with life on the Space Frontier, we will have no such luxury of aloofness or ignorance. Whether we prefer to live in space colonies, in lunar settlements, in pioneer Martian towns or elsewhere, the carefully set-up envelopes of Earth-life, water, and atmosphere we'll need to coddle our existence beyond our native womb-world, will have minimum tolerances for healthy functioning. The ecological facts of-life in the fragile exclaves of Gaia-Humanity will be immediate in their critical importance.

A Space Frontier Biosphere or Oasis might be described as a closed mini-world where everyone "lives downwind and downstream from themselves".

This means relentless vigilance in keeping the water and air clean beyond any standards set on Earth. Food chains will be short or telescoped. And waste biomass and organic materials must be efficiently and quickly recycled.

MMM Theme Issues: The Lunar Economy - Years 1-25 Dec 1986 - Nov 2011

To keep low both energy consumption and the need to radiate excess heat, we'll need to get the most product per energy input/heat-output as possible. Recycling, which recycles the energy of original processing as well as goods themselves, will be essential for all classes of materials.

Back on Earth, environmental consciousness is rising and is now the highest we've ever known. Yet, polls show people only care enough to want "someone else" to take care of the problem, and to do so without causing any personal inconvenience or forcing unwelcome changes in lifestyle.

It should be clear that if any such attitudes were common within a Space Frontier Biosphere, an environmental catastrophe most likely without hope of recovery, would follow all too swiftly. Nor will it be enough to have "a high level" of individual responsibility. Everyone within such frontier communities has to be "oasis-wise". It must be Second Nature to the Pioneers to live as if the dawn of the next day depended upon their rigorous respect for the Biosphere-Facts-Of-Life. For indeed, we'll survive one day at a time.

The only way to guarantee an oasis-wise citizenry, is to teach "Eco-Sense" to the children, not as an elective, nor as a mere requisite for graduation that can be put off to the last minute, but as one backbone of their education. Recycling – of the air, water, and biomass; of organic, synthetic, and inorganic materials – must be as important as Reading, (w)Riting, and (a)Rithmetic. Children must be taught Recycling as the Fourth "R"! Eco-responsibility has to become second nature. For if it is something we have to "remember" to do, we'll only do it when it's convenient or when someone else is looking.

Space Frontier Schools will have then a major role to play in guaranteeing the survival of the settlements they serve. The pioneer youth must learn not merely how to sort discarded items properly, but have a good understanding of how used air, water, biomass, and the various sorts of consumer materials are each routed back into the system upon which their shared lives depend. They should understand the raw materials and byproducts interdependence of industries and the interrelatedness of all those kinds of life that make up their mini ecosystem.

Students could be assigned recycling chores appropriate to their grade level to give them hands-on appreciation of how things work. The goal is not merely to produce good consumers and insure oasis-wise home-economics, nor merely to produce good entrepreneurs, industrial managers and workers, but to ensure that each citizen has sufficient appreciation of the Biosphere-Facts-Of-Life on which community survival depends, to vote intelligently and support only responsible political efforts. For while "lunacy" can be tolerated on Earth, there's no place for it on the Moon itself, or elsewhere in space.

PRIMARY SCHOOL

In Primary School, rote learning of the types of things to be sorted and recycled separately, of their names, identifying clues, and routes by which they are cycled back into the system, and of the current market uses of recycled items can all be gradually introduced. In art classes the students would use only oasis-wise media and craft stuffs, coloring agents, and finishes.

In frontier homes children could gradually be entrusted with the responsibility to monitor and manage the recycling chores within their households. They should be introduced to kitchen and garden composting, learning which food or garden scraps need to be treated separately. They can be encouraged to make things of pride from materials and discarded items.

No small part of early education would be to equip youthful vocabulary with sets of keywords and phrases having strong positive connotations. "Trash" and "Wastes", words of ill-repute, could be replaced with "Freed" used as a noun i.e. stuff relieved of previous service and ready for reassignment. ("Tommy, please drop off the freed on your way to school.") The rehabilitation of "alley economics" must start with the young.

HIGH SCHOOL

MMM Theme Issues: The Lunar Economy - Years 1-25 Dec 1986 - Nov 2011

At the High School level the entire curriculum should reflect Biosphere-Facts-Of-Life. In the teaching of Biology, attention should be given to natural air and water cycles and the steps at which these processes may need assistance within the mini-biosphere. The time it takes to biodegrade biomass waste and various types of organic materials should be covered. Not only should the Chemistry of atmospheric gasses be taught but also the nature of toxins, how they are produced both-in nature and industry, and they can be neutralized or prevented.

In teaching Import/Export Economics, the very critical role of recycling volatiles and already embodied energy must be stressed. An honest "Materials Accounting System" ought to be taught with its corrective affect on Financial Depreciation and Expense Accounting. And as an ongoing class chore/project, the economics class could maintain a Computer Database on some subset of recyclables under supervision of the University.

In industrial arts the concept of Whole-Sheet Scrapless Design can-be-brought home with school contests and competitions. Entrepreneurialism in the service of recycling can be encouraged by the J.C.s and in Junior Achievement projects, stressing the use of recyclables for which the market is slow. Industry could provide school art classes with access to slag type sources of "accidental art" to be mounted or set for sale.

A very useful Extracurricular Activity, with supervision, would be to take in worn, broken, parts-missing, and cast-off small durable items, especially including toys. These could then be repaired and rehabilitated. And where this is impractical, the items could be disassembled so all materials needing to be recycled separately, can be. Time can be allotted for "Serendipity" ephemeral sculptures from such parts.

UNIVERSAL CIVIC SERVICE

Nor should this "immersion" in the spirit and process of oasis-wise recycling stop with graduation from high school. In space frontier communities, where there will always be more to do than people to do-it, a Universal Civic Service after high school might not be a bad idea. Manning and maintenance of streetside recycling nodes, with care for their attractiveness and efficiency, operating other nodes in the recycling system, and other "schlepping" chores such as accident cleanups and maintenance of Parks and alleys are one way a "Citizen-Candidate" might pay his/er dues to frontier society.

Biosphere Maintenance is another appropriate dues-paying activity: i.e. manning the water-treatment and air-freshening facilities, various yeoman farming duties such as sorting spoiled produce and other biomass "freed" into mushroom matrix, animal fodder, and general compost.

Apprenticeships in the trades using recycled materials might also be considered for citizen-candidates if there are not enough of the above-listed job slots available. Cleaning refillables and other labor-intensive duties in the various recycling chains may also be in order.

The grand result of this thorough three step education process (primary and secondary schools followed by a stint of universal civic service) would produce Space Frontier Citizens who fully appreciated the fragility of their particular oasis of life and who forever remained deeply predisposed to live and act in an oasis-wise manner. We might even put some of these education ideas to use right here on our home planet.

MMM

MMM # 38 September 1990

Concepts of Regolith Primage

PRIMAGE

A "Do or Die" Key to Lunar Industrial-Agricultural Success

PRIMAGE By Peter Kokh

The pre-tilling of the Moon

Concepts of Regolith Primage

Through eons of meteorite bombardment, lunar soils have been extensively "gardened" or turned over vertically, and even mixed horizontally – up to half the surface materials in any given area is the import of splashout (impact ejecta) from areas nearby and distant alike. On Earth, mineral-based industries have been able to take advantage of enriched and concentrated deposits – a result of eons of geological processes peculiar to our planet. While undoubtedly somewhat more favorable concentrations of a few minerals do occur on the Moon (homogenization provided by bombardment not being 100% thorough), in general lunar settlers will have no choice but to make do with deposits we would shun as "uneconomic".

While the Moon is richly endowed, in a gross sense, the lunar economy will have the much more difficult job of separating out or beneficiating the desirable minerals prior to processing. No one should imagine that just any system of lunar mining-based economy would guarantee success.

In "Gas Scavenger" [MMM # 23 p.4 March 1989 – republished in MMM Classics #3] we pointed out that if we religiously extracted the pure iron fines and all the Solar Wind deposited gases from any and all regolith that we had to move or handle anyway, we would then accumulate potentially valuable reserves, at low cost, that could be one principal means of diversifying the settlement economy. We have to move regolith in excavating for shelters,

in covering them with shielding, in grading roadways, and in providing raw materials to ore processing facilities. Iron fine removal (by magnet) and gas extraction (by heat) capabilities should be an integral part of ALL regolith-moving equipment, we counseled.

Agricultural Needs

Let's carry the argument further. Apparently, some of the things that worry lunar agriculture researchers most, are actually characteristics of 'gross' lunar regolith easily changed in the handling process. After all, settlers won't be erecting domes over undisturbed lunar regolith, then attempt to farm this raw soil. We will be building pressurized agricultural modules of whatever volume – and then, moving regolith from the outside into the prepared beds within.

Researchers worry that the 15–20% fraction of regolith which is ultra-fine powder of less than 0.25 mm grain size, fine to medium silt, will clog soil pores leading to water-logged soil. In the Moon's light 'sixthweight', water will percolate through the soil more slowly; thus we will want somewhat coarser soil than is ideal on Earth. In the course of bringing regolith– soil in from the outside, this fine silt can be removed by vibration–sieving or by 'winnowing'. As a bonus, this unwanted fine silt may have a higher content of adsorbed Solar Wind gases; also it may be easier to process in some ways (glass?, ceramics? etc,) than less refined 'as-is' regolith.

The 75% ideal medium–sand–through–coarse– silt 1.0–0.25 mm fraction is next. A 3rd sieve removes larger agglutinate glass nodules which can then be transformed into zeolites by mild hydrothermal processing [150°C , 0.3 MPa, 76 h]. Zeolites are hydrated silicates of aluminum with alkali metals (K, Na) and cavity-rich crystal lattice structure. They can be used as catalysts, adsorption media for gas separation, insulation, and molecular sieves. And added back into the "soil," they will enhance mineral ion transport to plant roots, especially in early 'immature' soils not yet fully colonized by micro-organisms nor laden with organic matter. How to provide for sufficient mineral ion transport in regolith-derived soils is thus another

MMM Theme Issues: The Lunar Economy - Years 1-25 Dec 1986 - Nov 2011

needless worry on the part of researchers. [In view of these possibilities, I am rather critical of the value of lunar agriculture experiments that use any lunar simulants formulated on the unexamined presupposition that we will be stuck with using crude raw regolith.]

The remnant after this last sieving operation would be larger rocks (aggregates and breccias) that could serve well as gravel fill, for lunar concrete. So, just by including this multi-step vibra-sieving operation in our "Regolith-mover", we will have (1) enormously enhanced the chances of success for lunar agriculture; (2-5) started businesses in molecular sieves, gas-separation, catalysts, and insulation; (6) supply the highly refined material needed for processing; and (7) supply coarser material for 'lunarcrete' mix.

A third worry of the Lun-Ag people is potentially toxic levels of chromium and of nickel in regolith-derived soil. Their concern is perhaps more justified with chromium, as observed nickel concentrations are possibly tolerable. How we could make use of regolith pre-handling opportunities To extract a significant fraction of the Chromium-containing minerals (e.g. some spinels) is a nice challenge for the chemical-engineering types among our readers. How about it?

A Tool for Many Needs

Now that's quite a work load for our everyday Lunar 'Lith-Mover! Iron fines; Solar Wind gases; silt for processing; Ag-grade soil; zeolite feed stocks (glasses) for agriculture filtration and insulation; gravel for lunarcrete; chromium ores. We can obtain all these in the very handling of regolith, prior to all other forms of processing - including oxygen-extraction and glass-glass composites (Glax) production. For these collective First Fruits, I propose the term "Primage." [Most dictionaries define this term solely as a safe-handling bribe paid by a shipper to ship's captain and crew. But as a suggestive precedent, the O.E.D. also has: "the amount of water carried off suspended in the steam from a boiler" (about 3%)]

A Primaging 'Lith-Mover

Going through all the bother of careful regolith-primage, much like scraping and sanding the loose paint before repainting, will seem to most a thankless and unwelcome ritual. There will be a strong temptation to dismiss the need. But the settlement that adopts primaging as a transcendental imperative, will have a significant head start towards economic diversification and self-sufficiency.

Primaging could be the well-spring both of prosperous lunar industry and of productive lunar agriculture. Developing a practical, simple and rugged "Primaging 'Lith-Mover" should then be among our very highest priorities.

MMM

New ideas pass through three stages:

Stage 1: "It can't be done."

Stage 2: "It probably can be done, but it's not worth doing."

Stage 3: "I knew it was a good idea all along!"

"Clarke's Law"

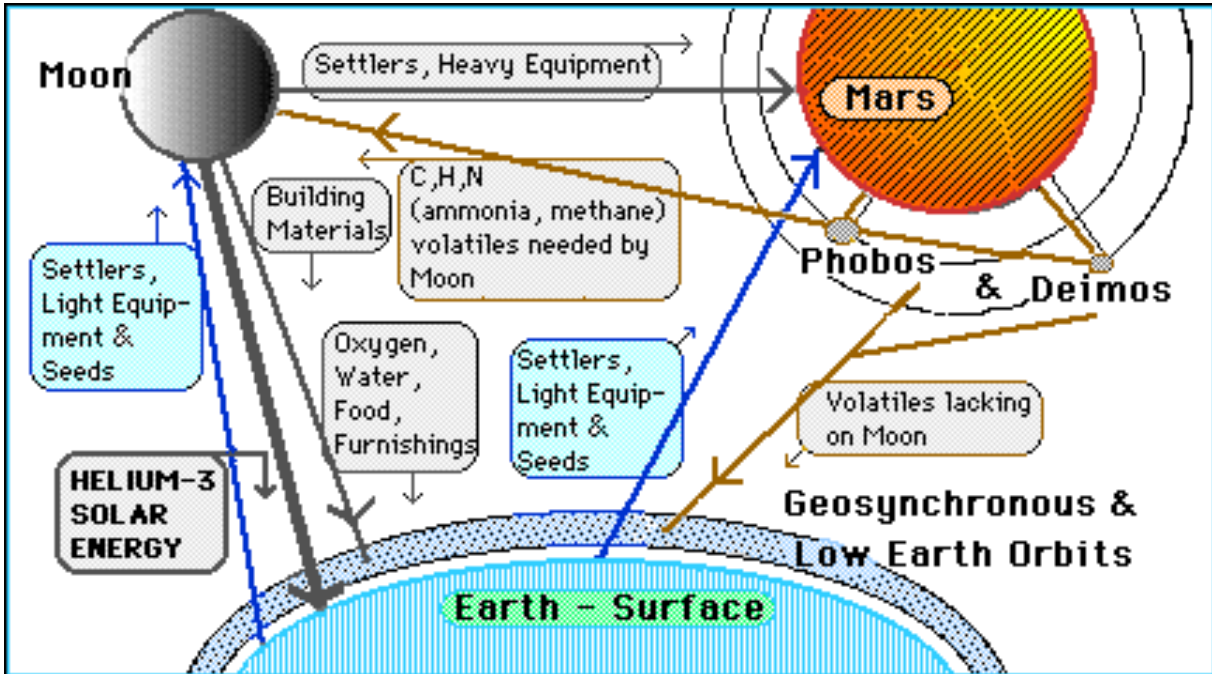

How an Earth-Moon-Mars Economy might work

What gets shipped where depends on the price delivered, and unless time is of the essence, shipping costs can be the decisive factor. There is an up and down in space if you consider gravity wells. The deeper the gravity well, the more fuel it takes to launch out of it.

Anything lunar settlements make for themselves will be cheaper to ship to markets elsewhere in space than equivalent products made on Earth. Thus lunar building materials and furnishings and other items made for lunar pioneers could well find themselves in low Earth orbit and Geosynchronous orbit stations, hotels and resorts, industrial parks, etc. Such exports would help pay for things made on Earth that could not easily be produced on the Moon.

The biggest market might be building materials for solar power satellites, power relays, and multi-satellite platforms, all in GEO.

The diagram also shows how Mars could fit in with its two moonlets Phobos and Deimos playing a key role. As it turns out all space destinations have a better chance to thrive and prosper as mutual trading partners than any of them would on their own. So it is in the Moon's interest that a Mars frontier be opened, and vice versa. The asteroids will plug in to this trade network in turn. MM

MMM # 65 May 1993

Lunar Industrialization: Part II By Peter Kokh

the
substitution
game

MMM Theme Issues: The Lunar Economy - Years 1-25 Dec 1986 - Nov 2011

A spectrum of stratagems will be needed to cope with “LDEs” – “Lunar-Deficient Elements”

One can hardly establish a self-sufficient population on the Moon, or anywhere else, on the basis of locally producible building materials alone – however good a foundation that may be! The crucial facts affecting a Lunar Balance Sheet are the hard-to-do-without non-luxury items that cannot, or cannot yet, be locally manufactured from indigenous materials.

At first, the list of such needs will seem discouragingly long and “weighty”. But as we succeed in producing more and more secondary elements from the Lunar regolith soils [See the March issue # 64], the list of things that must be imported will shrink both in number and in total mass (per inhabitant to be supported) to a somewhat more palatable but stubborn core. Sooner or later, the law of diminishing returns will step in to discourage further efforts.

The Operative Philosophy is a 2-sided coin with which to help pay the settlement’s bills:

A) Minimize imports by learning to do without or finding locally sourceable substitutions. For example, furniture and furnishings will rely on metals, glass, and ceramics rather than wood, plastics, and fabrics. Such substitutions will carry us only so far, however. We must try to develop and pioneer new types of lunar-appropriate materials to make such restrictions less chafing. Glax, or Glass-glass composites, is one of these new families of materials.

B) Choose imports to best advantage

(1) Stress capital equipment over finished items on an aggressive schedule:

grow the settlement population in step.

(2) Import only those components that cannot be made on the Moon, rather than whole assemblies, and redesign both Made-on-Luna products and major and frequent imports from Earth accordingly. In other words, we “count on” substituting Lunar made components wherever possible and plan the diversification of settlement industry in a just-in-time basis.

✓ See the article “MUS/CLE “ below.

(3) Bend over backwards not-to-import items made of elements in which the Moon is well-enough endowed. Here our “No-Coals-To-Newcastle” strategy is to make well-thought-out substitutions on Earth with respect to the composition of things sent to the Moon. This policy will be against the grain to carry out, entailing extra effort and sometimes significant upfront expense. But the rewards of pursuing such a mandate faithfully will be be accumulatively rewarding for the pioneers and could very well make or break their long term mission.

(4) an aggressive effort to wrap and package import items only with cannibalizable “tare” stuffs composed of elements that cannot (or not yet) be economically produced on the Moon. We can use alternative packaging materials made of metals or alloys embodying Lunar deficient elements. We can also formulate them out of hydrocarbons and other volatiles. If we are especially determined to tilt the game, we might go much further and consider which parts of Earth-Moon vehicles and their outfitting could eventually be replaced item for item with things made by the settlement. The original equipment could then be made of “Lunar deficient” and be intended and designed to be cannibalized upon Moonfall. In both these categories, tare stuffs and lunar-replaceable outfittings, we are making strategic Earthside substitutions to provide limited endowments on the Moon of certain very critical elements.

✓ See the article “Stowaway Imports” below.

“The Substitution Game” will require careful and very detailed planning if the results are to approach the potential. This means that an autonomous “Settlement Authority” answerable only to settlers and settler candidates must be in charge. If Earthside governments call the shots in business-as-usual fashion, non-germane political considerations and budgetary myopia will result in token half-measures. The predictable result will be that the odds against timely settlement success will be heavily stacked by negligence, apathy, and competition for attention.

MMM Theme Issues: The Lunar Economy - Years 1-25 Dec 1986 - Nov 2011

Imagine a settlement designed and operated like NASA's shuttle fleet and you get the idea. We'd get the short-term gratification of starting human outposts on the Moon only to see the whole grand effort inevitably collapse of its own negligently unsupported weight.

A whole spectrum of substitution gambits must be devised, designed to work in concert like some materials eco-system. A number of major enabling technologies need to be developed to make this all possible. And at least here and there we'll find terrestrial applications for some of these efforts.

The ultimate payback will be making economically feasible a sizable settlement that can support the delivery of clean space-sourced energy to Earth. While Earthsiders may show little direct interest in the success of the Lunar endeavor, their indirect stake will be collectively enormous. PK

The Fast Road to Lunar Industrial



And the "Substitution Game"

By Peter Kokh

"MUS/cle" is a mnemonic acronym we coined in a previous article on Lunar Industrialization strategy in MMM # 18, SEP '87 pp 3-4. The first syllable **MUS** endeavors to point out the type of products it is appropriate for a small lunar outpost to try to make in an effort to cut down on the tonnage of imports needed to support its existence. "**M**" stands for massive items and components, "**U**" for unitary items or things manufactured in large quantities, "**S**" for items that are fairly simple in design and manufacturing process. Sometimes an item will be M, U, and S all at once, sometimes not.

The "**cle**" syllable, usually in small letters to get across that this suite of items represents much less aggregate tonnage, endeavors to point out the type of things that are best left to Earthside manufacturers because they are "**c**" relatively complex in assembly and require sophisticated manufacturing from a host of parts and subassemblies supplied by a large number of diversified subcontractors, and/or "**l**" lightweight, at least by comparison, and thus much less burdensome for the settlement to upport out of Earth's gravity well. Such items often include "**e**" electronic components or assemblies.

Such a MUS/cle strategy for deciding what the young settlement should try to self-manufacture and what it should rest content to upport is absolutely necessary. Space advocates talk frequently about settlements becoming self-sufficient or able to pay their own way. But the cold fact is that while in simpler ages, now irretrievably long gone by, smaller towns could make most of what they needed, in today's increasingly technical civilization, it is estimated that a city has to have at least a quarter of a million people (250,000) to be able to support an industrial base sufficiently diversified to satisfy 95% of its own needs. Self-sufficiency is an asymptotic goal, of course, one which (like the elusive speed of light) requires exponentially more heroic effort to continue closing the gap the closer one gets to it. Thus, for example, a more modest goal of 60% self-sufficiency might be achieved by a town of only 25,000, just 10% as large (to grab a figure out of the air).

While the law of diminishing returns must eventually step in to make further efforts at self-sufficiency unrewarding, it will make an enormous difference in how we plan, or fail to plan, expansion and diversification of the lunar industrial base. "MUS/cle" gives us a serviceable rule-of-thumb guideline.

MMM Theme Issues: The Lunar Economy - Years 1-25 Dec 1986 - Nov 2011

Following this guideline, we need first to look at the list of material items our settlement will need in terms of gross tonnage per item. Obviously shelter is at the top of the list. But included in the upper ranks are many other things that can be made of the same indigenous “building materials” suite needed to make shelter (metal alloys, glass, glax, ceramics, Lunacrete) namely tankage for volatiles, vehicle body parts, furniture, utility system components, etc.

Now the “Tonnage Of Imports Defrayed” [TOID: a Lunar Accounting Term on the same side of the Balance Sheet as our “Retained Earnings”] is not our only consideration. It is also extremely important to see that scarce lunar person-power is used as productively as possible. This will mean not only output per person (a “ton of dishes” over a “ton of computers” as a goal for self-manufacturing) but rather more significantly, **exportable output** per person. It reinforces our belief that “MUS/cle” puts us on the right track that many “MUS” items and components self-manufactured on the Moon for settler’ use are also high on the list of potential moneymaking exports to markets in Earth orbit, L4 & L5, expeditions to Mars and the asteroids, etc. We’ll talk more specifically about exports in the closing installment in this Lunar Industrialization series.

The “MUS/cle” paradigm will not take us too much further than this if we limit it to ‘whole’ items. “Phase II” (logically; in fact it must be implemented alongside Phase I from the very outset) is to look at every more complex item that the settlement needs and see if it can be broken down into “MUS” components for local manufacture (example appliance cabinets or casings) and “cle” parts for shipment from Earth.

“MUS/cle” Inspired Industrial Design

To maximize the potential, it may well be necessary to do some serious industrial redesign of the items in question to better segregate and maximize the potential “MUS” components, and to better integrate the remaining “cle” components in “works cartridges” for subsequent labor-light mating and assembly on the Moon. This may seem a costly burden for Earthside suppliers. But forces now at work are slowly forcing industrial designers to rework their products even now. In Europe, it is becoming the law that manufacturers must buy back their own products (once they are unwanted) for recycling. In order to make recycling easier, these products are being redesigned so that they can be easily disassembled into various types of recyclable components. “MUS/cle” provides a compatible and enhancing guideline for industrial designers, and is especially appropriate for today’s multinationals who manufacture components all over the globe. So “MUS/cle”- inspired Industrial Design is a promising **career choice** for one motivated to do his/her part to push the opening of space.

The “MUS/cle” Program can be 100% Retroactive

The cynic will say that there is no hurry here because the settlement will not be able to supply the potential “MUS” components for some time. So we might as well save some money and ship ready-to-use items as we now have them. Such (any!) cynicism per se blinds its slave to opportunities. While the above assertion is undeniable on the face of it, it is in fact only half a truth.

IF we go ahead with “MUS/cle” redesign and then, while awaiting the step by step growth of Lunar industry, build ALL of the item on Earth, **but** manufacture the “MUS” component out of metal or volatile elements which the lunar community cannot, or not yet, economically extract from the available regolith soils, we will be shipping to the Moon not only a needed item, but, as a relatively cheap bonus, providing a “**yoke sack**” of Lunar Deficient materials. Once the settlement can self-manufacture the appropriate “MUS” parts, the original Earth-made parts can be cannibalized for their content as they are eventually replaced. Such endowments will enable the settlers to make an end run around their deficiencies.

“MUS/cle” is a radical growth strategy to guide the planners of lunar industrial diversification in setting priorities and schedules. More, it is a strategy to radically filter the design of anything and everything that is shipped to the Moon from day one on. At first the payback will be but a promise, but eventually, religiously pursued, the “MUS/cle” strategy will

MMM Theme Issues: The Lunar Economy - Years 1-25 Dec 1986 - Nov 2011

outperform any savings bond. “MUS/cle” must be a key instrument in the “Bootstrapper’s Toolbox”.

MMM



Using Hitchhiker and Bonus Imports to Hasten Settlement Self-Sufficiency

STOWAWAY IMPORTS By Peter Kokh

Three Opportunities for strategic substitutions

There are three basic categories of opportunity to ship to the Moon badly needed “Lunar deficient elements” – strategic metals and volatile feedstocks – virtually “for free”. That is, the freight is actually being billed to other import items, and would still be levied ... whether these opportunities are seized or not.

These are (1) containers and packaging materials or “tare stuffs” used to ship the principal items on the Manifest; (2) parts and components of imported items that would normally be made of elements in which the Moon is already well endowed [see the end of the “MUS/cle” article just above]; and (3) cannibalizable parts of the shipping vehicle or of its outfitting that either are not needed for the return trip to Earth and could be replaced there, or which could be replaced with Lunar substitutes upon arrival on the Moon.

In all three cases, play in the “substitution game” is initiated on Earth. In the second and third case, there is a “counter” or “complementary” substitution made on the Moon. In the second case, this match move could be delayed for some time, the endowment being “banked” in the imported item as it is being.

What substitutes for what?

On the one hand, the stuffs, parts, and components in question are those that would normally be made of elements for which the settlement has no need, namely, those which can be produced economically on location: oxygen, silicon, iron, aluminum, and titanium especially. The operative rally cry here is “No Coals to Newcastle” i.e. no ice for the Eskimos, no sand for the Saudis, etc. Shipping or co-shipping items so formulated constitutes no less than a criminally wasted opportunity to bootstrap industrial diversification.

Instead, we want to substitute other metals such as copper, zinc, lead, gold, silver, platinum, etc., or alloys rich in them such as duralumin, monel, bronze, brass, pewter, etc. Where such substitution is impractical, an alternate option is to preferentially use stainless steel or any of several other industrially desirable steel or aluminum alloys for which the alloying ingredients cannot be easily produced on the Moon.

Some constraints apply: the substitute metals must be formulated to perform adequately, and must not involve added weight. The trick is to avoid paying a weight penalty in substituting heavier metals for lighter ones by using less of them or by other tricks. If this pitfall is avoided, substitution costs aside, the actual transportation costs will be nil, charged as “overhead” on the bill for the principal shipment, whether the helpful endowing substitution is made or not.

MMM Theme Issues: The Lunar Economy - Years 1-25 Dec 1986 - Nov 2011

As to oxygen, it is a principal component – often in the 50% range – of paper, cardboard, wood, plastics, styrofoam, and other materials often used as containers, packaging wrap, separators, and fill. Instead, it will be to the settlement's great advantage to substitute tare stuffs formulated from low polymer hydrocarbons that can easily be broken down into the constituent hydrogen and carbon – both very precious on the Moon – or used as chemical feedstocks in Lunar industries.

Other substitution possibilities include soaps and waxes and friable or biodegradable compositions rich in those agricultural micro-nutrients or fertilizers in which lunar regolith soils are impoverished. A stuffing and cavity-filler option that could sometimes be appropriate would be to use air- or freeze-dried luxury food items (to be reconstituted with water made with lunar oxygen) (e.g. fruit, milk, eggs, spices) not likely to be produced in the early stages of lunar agriculture and which would add much to special occasion menus and to overall morale and morale-dependent productivity. Such items (along with human wastes from arriving ships) will be much valued accumulating additions to the local biosphere.

Oxygen is also an unnecessary 21% of the Earth air with which cargo holds would normally be pressurized. Instead we could use pure Nitrogen, the extra 21% most appreciated on the Moon. For the return trip, the holds could be pressurized with Lunar Oxygen, either alone or buffered with Argon and Neon scavenged from the regolith by modest heating.

As every gram of pest potentially takes the place of many pounds or tons of food or product in the food chain, pressurizing holds filled with seeds and seedlings with pure Nitrogen, heated to 65° C (150° F) or so could be doubly important. Attention to a whole host of "little" opportunities like this could make the difference to settler self-sufficiency. Lost nickels and dimes add up quickly to real lost dollars.

"Changing the Rules:" Cannibalizing Outbound Vehicle Equipment

Passenger and Cargo ships alike bound for the Moon will contain many components, parts, and items of outfitting that are either not strictly needed for the trip home, or which could be replaced by Made-on-Luna fabrications for the trip back to Earth. If these ships are deliberately designed and outfitted for cannibalization, the cost of off-the-shelf assembly-line-item reoutfitting per flight could actually be less than the customary one-time individually customized outfitting that has become NASA's one-trick pony.

Certainly this will involve a major paradigm shift for those spacecraft designers and their cheering sections who currently are aware of only two sacred cow choices: Expendable and Reusable – neither of which are anywhere near appropriate for opening the frontier. These two are like Thesis and Antithesis. The Synthesis is to send ship[parts] one way to the frontier for "Reassignment" there. So add Reassignable to Expendable and Reusable. It's a frontier door-buster.

Until industries are in place to fabricate replacement parts, only those items not actually needed for the trip home can be removed upon Moonfall for cannibalization. Gradually, other parts can be replaced on the spot with prepared Lunar fabrications. We'd be removing items made of Lunar deficient metals and alloys and volatiles and replacing them with items made of Lunar abundant materials (iron, aluminum, glass, glax, ceramics etc.) from basic settler industries.

What type items are we talking about? Nonstructural (akin to non-load-bearing) interior partitions; floor, ceiling, and wall panels; interior doors and trim; fuel tanks, eventually even cargo holds, platforms, exterior booms and beams etc.

For ships carrying settler recruits one way and returning empty except for crew, the list includes the partitions and decor panels of individual quarters, dishes, cutlery, and food preparation equipment, cabin furniture and furnishings, entertainment equipment and libraries, beds or berths, bedding and towels, sinks and toilets, even snap-in/snap-out copper wiring harnesses. If you use your imagination, the list gets surprisingly long and potentially all-inclusive.

Indeed, we'd have the choice of either stripping the passenger cabin or removing it wholesale to be mated to a new chassis and used as a surface coach! Or perhaps covered with

MMM Theme Issues: The Lunar Economy - Years 1-25 Dec 1986 - Nov 2011

regolith and used as a construction shack in the field! Even here, we'd want to have as much as possible of the cabin and its original outfitting made of Lunar deficient materials for gradual retrofitting replacement with local fabrications allowing the original materials eventually to be cannibalized.

Best of all, the fuel expended in getting all this accessory equipment to the Moon gets billed as part of the passenger fare or cargo freight whether any of this stuff is removed or not. So IF we designed the craft and its outfitting for this kind of wholesale reoutfitting each trip, using "knock-down" assembly techniques to make the job a breeze, the settlement can get all this "loot" virtually for free.

If you think about it, the whole concept of Reassign-ability absolutely shatters up till now universally accepted fuel to payload ratios. Potentially, everything except fuel becomes payload. And that changes the economics of opening the space frontier quite independently of whether or how soon or how much we realize cheaper access to Earth orbit.

Earthside Entrepreneurial Opportunities

Formulating and fabricating items out of elements scarce on the Moon instead of those abundant there may or may not lead to terrestrial applications. That depends largely upon entrepreneurial imagination and market testing. Making tare items (containers and packaging etc.) of alternate materials should certainly lead to marketable products for consumers who are becoming increasingly sensitive to the environmental impact of everything they use. The idea of making things to be reassigned and/or cannibalized is sure to have applications both in the consumer products field and in the continued opening of terrestrial frontiers like Antarctica. Imagination is the only limit.

The Bottom Line

To a lunar settlement, every pound or kilogram of imports or co-imports "along for the ride" made of elements economically producible on site "costs" a pound or kilogram of dearly needed "lunar deficient", hard-to-do-without elements not locally producible, that could have been imported instead for the same import bucks. This is the kind of opportunity that a for-profit operation seeking to open the frontier would eagerly seize upon. It is also the kind of opportunity that deficit-jaded government operations routinely shrug off.

Taking the pains to reformulate these potentially free "stowaway" imports will slowly but inexorably build up substantial endowments on the settlement site that will go a long way towards removing the severe industrial handicaps under which the pioneers must otherwise operate - and all virtually free of real added cost. The fuel expended to get these items there, reformulated or not, is in effect a hidden import tax. As this tax must be paid anyway, it'd be unforgivable not to use the bootstrap opportunities involved. **MMM**

What is needed is not a one-time sprint to a nearby planet,
But a slow, patient expansion away from Earth,
A long-term program, perhaps taking a century to complete.
That would equip us not just for a single interplanetary joy ride
But for the coordinated exploration of the deep solar system.
- Isaac Asimov

"The innovator has for enemies all those who have done well under the old conditions."
- condensed from Machiavelli

MMM Theme Issues: The Lunar Economy - Years 1-25 Dec 1986 - Nov 2011

Producing for Export: Bringing Home the "Bacon & Brass"

BACON & BRASS By Peter Kokh

Relevant READINGS from Back Issues of MMM

[included in MMM Classics #1] MMM #2 FEB 87 p3 "Essays in M": M is for Market

[included in MMM Classics #3] MMM #22 FEB 89 p3. "1st Exports"

[included in MMM Classics #4] MMM #32 FEB 90 p4 PRINZTON; Part VI:

C. Lunar Export Categories; D. Export Destinations; E. Strategies to Increase Exports.

Despite a dedicated "MUS/cle" program [MMM # 18 SEP '88 pp. 3-4 "Lunar Industrial MUS/cle", and MMM # 65 MAY '93 pp. 7-8 "The Fast Road to Lunar Industrial MUS/cle and the Substitution Game"] and an aggressively played "Substitution Game" [MMM # 65 May '93 p.3.], there will still be a stubborn core of costly imports, including, most importantly, the "passage" of settlers themselves. Frontier settlements must pay this bill with the coin of export earnings. Accordingly, with all due respect to the law of diminishing returns (i.e. there comes a time when added effort does not yield commensurate reward), every opportunity to diversify exports and take advantage of new market niches must be explored.

The "Cost of Living" on the Moon may well be astronomical, measured in dollars. But the Lunan "Standard of Living" may be quite comfortable nonetheless — if Lunans can find enough ways to pay the bills. We think they can.

In theory, the export potential for lunar settlements is both much broader and much deeper than most would suspect. In reality, everything will depend upon 1) how fast the lunar economy can diversify, 2) how favorable is the climate and support structures for entrepreneurial initiative, and 3) how fast the productive sector of the settlement population can be made to grow. All three of these questions deserve articles or series of articles in their own right. We'll treat each of these topics in future issues. Right now we want to explore the potential.

Lunar Exports to other Space Markets

If the first rule of import policy is not to import more of what you already have (the so-called "no coals to Newcastle" policy i.e. the Moon should avoid importing items rich in silicon, oxygen, aluminum, iron, titanium, calcium, and magnesium) the first rule of export policy is just the reverse. The settlements must strive to exploit the potential market value of those very same indigenous assets to the fullest. All lunar development scenarios start out in this same direction. And then they pull their punches.

Let us take oxygen for our first example. It is now the common wisdom that production of liquid oxygen be given first priority. This oxygen would be intended for use as rocket fuel oxidizer to help reduce the fuel cost of imports, and to make water for the settlement by combining it with imported hydrogen in fuel cells, a process which will recover, hopefully during nightspan when it is needed most, some of the energy which went into its production.

Liquid "lunox", would not only be used for Moon to Earth travel, but could also be delivered at a substantial competitive price advantage to low Earth orbit, where it could help refuel new outbound deliveries. But this seems to be the limit of imagination in published scenarios.

By the same token (oxygen can be delivered to LEO from the Moon at substantially lower cost than it can be resupplied from the much nearer surface of Earth just below), Lunox should be combined with hydrogen brought up from Earth to make all the water used in low Earth orbit facilities: space stations; tourist resorts; orbital processing and manufacturing facilities, etc.

Pressing the advantage a step further, the cost is still more than competitive if the lunar oxygen arrives in LEO already combined with terrestrial hydrogen to make the water and protein and carbohydrate in food tissues. Of course these savings will be maximized if only dehydrated or concentrated food product is shipped from the Moon, along with the oxygen with which to

MMM Theme Issues: The Lunar Economy - Years 1-25 Dec 1986 - Nov 2011

make the water needed to rehydrate it. In short, there is a market in LEO for lunar agricultural products — in LEO and any other space location at which on site food production is inadequate to fill the need.

Lets extend the argument to building materials made from lunar regolith soils: metal alloys, ceramics, concrete, glass, fiberglass, and glass-fiberglass composites (“Glax”). It may well be that the biggest market for such products is in construction of space-based facilities: new and more spacious space stations, orbital resorts and factories, solar power satellites, space construction camps and space settlements etc. But just as on the Moon itself, there is a substantial secondary market for these materials in utility system elements and in furniture and furnishings, these very same items can be produced in excess of local lunar need for export to all of the above space markets.

On the Moon, the cheapest fabric will be locally produced naturally dyed [see MMM # 48 Sep 91 p. 8] cotton since it is an unrivaled 50% lunar oxygen by weigh. Given the lower fuel costs needed to bring it to market in LEO and other space sites, lunar cotton and the apparel made from it should be marketable at a real price advantage over fancier cottons and other fabrics produced on Earth. This argument extends to other cotton uses as well: upholstery material, toweling, bedding etc. Lunar grown linen will enjoy a similar advantage.

In short, the Moon will not only **build** the bulk of future space facilities, but **outfit** and **furnish** them, and **feed** and **cloth** their occupants. That’s a diversified export basket!

But we can do more. There are many items that we can expect to be in demand in the various space locations but on which lunar enterprises will not soon, if ever, be prepared to enter a complete bid. Yet if lunar appropriate industries can supply some of the weightier components – according to the MUS/cle scheme – then the potential cost savings through lunar sourcing may make it attractive to assemble the needed items in space, using lunar and terrestrial components both.

We are talking about products in which “the works”, the complex, often electronic, and sometimes lighter weight subassemblies that can only be manufactured by sophisticated techniques on Earth require for completion a casing or cabinet or body or support structure that is functionally simple enough to be made of a wide variety of basic materials, and often (not always) comprises the more massive fraction of the total item. These latter less demanding components can be manufactured on the Moon just as easily as on Earth. Items in this category include major and minor appliances, machine shop tools, vehicles – yes, even space vehicles. See the article “COSMOTIVE, INC.” below.

Its simple, really! The same industrial “MUS/cle” strategy that can help lunar settlements minimize the total tonnage of imports they need to survive and grow, also provide them with a strategy to maximize their collective penetration of other space markets.

Lunar Exports to Space Markets	Lunar Exports to Earthside Markets
OXYGEN (air, rocket fuel, water constituent)	ENERGY (lunar built solar power satellites; lunar solar arrays; helium-3 fusion fuel)
OXYGEN-RICH (food, cotton goods, farm products)	TOURIST EARNINGS ETC. (lunar vacations, use of lunar owned facilities and vehicles elsewhere)
BUILDING MATERIALS (iron & steel, aluminum, titanium, magnesium; ceramics, concrete, glass, fiberglass, glass-fiberglass composites)	MANUFACTURING LICENSES
MANUFACTURED GOODS (furniture & furnishings)	GEOSCOPY (lunar remote sensing installations)
COMPONENTS (tanks, shelter, vehicles, machines, appliances, and more)	MISCELLANEOUS (souvenir giftware, arts and crafts, movie studios, television productions)

Lunar Exports to Earth Surface Markets

None of these strategies will help Lunans come up with items to sell directly to Earth. All of those categories in which lunar enterprises can be competitive in Earth orbit and beyond will on Earth itself be far more cheaply purchased from even the most exclusive and expensive of terrestrial suppliers.

MMM Theme Issues: The Lunar Economy - Years 1-25 Dec 1986 - Nov 2011

Space-based energy will clearly be the most profitable of the Moon's exports to Earth itself. This trade will be indirect in the case of solar power beamed from satellites and relay stations constructed in space largely of lunar materials. If lunar surface-based solar arrays are used, profits may be higher even if energy collection-transmission efficiency is less.

And then there is Helium-3. If fusion power becomes a major player in the terrestrial energy supply mix, and if the exploitative (in the worst sense of the term) "see-want-take" regime has been rejected in favor of "purchasing for fair value" from those who live where the supply is to be found, the percentage of profits from the energy trade that flow directly into lunar coffers could be the greatest.

A very respectable second Moon to Earth export could be tourist experiences. See the article "TOURIST EARNINGS" below. For a long time this market will be small, limited to the slowly growing "jet setter" class given to vacations that are well out of the ordinary and well beyond common means.

For those who can only dream about in-the-flesh travel beyond Earth's atmosphere, film making studios on the Moon will take in some small fraction of the terrestrial entertainment dollar supplying the Earth-bound with the vicarious second best. Lunar TV stations carrying sports events and dance spectacles unique to the Moon's fractional gravity ("sixthweight") could someday earn a respectable portion of the terrestrial commercial advertising dollar.

Then there is income to be earned from the sale of manufacturing licenses for processes and products developed on the Moon but for which there is potential demand on Earth if shipping costs can be factored out. At the other end of the spectrum, for those who don't have to ask "how much does it cost", there will be a small luxury trade in lunar souvenirs and giftware, furnishings and fashions, jewelry etc.

Geoscopy - dedicated scanning of the Earth's surface, is an area in which lunar surface installations may in some instances be less expensive to deploy, cheaper to maintain, and less constrained by size and mass restrictions than those incorporated into Earth orbiting satellites. Interferometric remote sensing in the full range of the visual spectrum as well as in other ranges of electromagnetic radiation could become a modest money earner.

The list above is by no means either definitive or all inclusive. Yet you can see that it includes energy, materials, manufactures, arts and crafts, experiences, and services. On Earth those nations do best over the long haul that are not dependent on just one narrow export category but rather have diversified their export offerings with a wide range of mineral, agricultural, and manufacturing products - and services. It will be no different with nations whose homelands lay beyond Earth orbit. Earning too large a fraction of the trade dollar from just one item is a prescription for disaster. Such monocrop or monoprodut reliance makes a national economy vulnerable, wide open to collapse if another cheaper source is found for their one and only commodity.

It takes all kinds of people with all kinds of talents to make a society. It takes all kinds of products and services to make an economy. So too, it takes all kinds of products and services to make a healthy export base. The lunar frontier economy has this potential to fill this mold someday, and it should be able to play the game well - if lunar industrialists and entrepreneurs exploit all the aces and play all the trump cards their adopted home world offers them.

MMM



FOR SALE: Unforgettable Experiences & Unequaled Opportunities

TOURIST EARNINGS By Peter Kokh

MMM Theme Issues: The Lunar Economy - Years 1-25 Dec 1986 - Nov 2011

Profits from space tourism to be plowed back into the Lunar economy, can be earned for the Moon only to the extent that the tourist operations involved are owned, operated, and equipped by settlers. If at first this seems an unlikely scenario, consider the cost of building tourist resorts in LEO [Low Earth Orbit] from materials brought up from Earth in comparison to cruder yet comparable facilities built of materials processed from lunar regolith – the twenty-fold savings in freight charges will tip the edge to companies able to supply the latter, once the necessary upfront capital investments have been made.

Initial LEO resorts prefabricated on Earth will be small, however luxurious. Ample and spacious complexes able to accommodate a much wider range of activities (read zero-G sports and recreation) will have to await the breakthrough in construction costs promised by NTMs — Non-Terrestrial Materials. Compare 50s era Las Vegas resorts with those of today and multiply the difference by a hefty factor!

That said, earnings from the use of lunar materials to support expanded tourist opportunities in space will only flow into lunar accounts to the extent that the building materials manufacturers and construction companies involved are settler-owned and/or settlement-taxed. Unfortunately, there are ample past models for exploitative colonialist rape-theft of foreign resources to give us ample warning that without the proper legal-political-economic regime in place, space frontier settlers could well end up not seeing a penny of the profits. Indeed, some of these unsavory practices have been at least implicitly advocated in development schemes put forward by some space advocates emotionally opposed to surface settlement by “planetary chauvinists”.

Assuming that we set things up right however, the construction, outfitting, and servicing of tourist facilities in LEO should provide a major market for the lunar economy. After all, tourists are the one thing it is far more profitable to source from Earth than from off-planet! And LEO is their handiest, least expensive “off shore” destination.

“Build it and they will come” — for the rocket-thrust experience of liftoff, for the sensation of weightlessness, and for the angelic, olympian views. Those not plagued by space-sickness will get “the experience of a lifetime” promised by the hype ads. As ticket prices moderate and demand increases it will become profitable to offer “enhanced” orbital vacations.

Exercise, sport, and even dance classes and events will exploit the opportunities of weightlessness. To make the most of the unparalleled views, there will be both “heads-up” view-plate display aids and experienced human guides to help sightseers identify and understand the geographical, geological, ecological and environmental, geoeconomic, and meteorological clues in the brilliantly sunlit panoramas below.

Picking out major and minor cities by their night lights will be a popular pastime. For astronomy buffs, the twinkle-free brilliance of the quickly shifting starscapes will bring a foretaste of heaven.

The leap from Earth Orbit tours to deep space excursions such as lunar swingbys is relatively easy. [MMM # 21 Dec. '88 pp 2-5 “Lunar Overflight Tours” available by SASE plus \$1 to “LRS”] If part of the vehicles (and their outfitting) involved is “Made on Luna”, some of the revenues from this extension business will help boost the lunar economy. Better yet if the companies serving this trade are settler-owned.

Tours to the L4 and L5 Earth-Moon co-orbital fields, which may be the site of considerable construction and manufacturing activity and boast settlements of their own, will also become popular early extensions of LEO tour stays. From these twin vantage points, Earth and Moon can be seen together, 60° apart, and in similar phases (new, half, full, etc.). Excursions still further out may also be available.

As to “land excursions” on the Moon, in the early days when the preoccupation will be with building and establishing the first settlements and coaxing them toward some degree of self-sufficiency, it may not be possible to “visit” the Moon except on “working tours” as part of construction or prospecting crews, much as people now pay to go on archeological “digs”. Eventually, traditional “pampered tourist” type vacations will be introduced.

MMM Theme Issues: The Lunar Economy - Years 1-25 Dec 1986 - Nov 2011

Such offerings will probably await the day when any and all new pressurized habitable space on the Moon is constructed of materials processed from the local regolith soils. Until then, the per square foot cost of habitat prefabricated on Earth will be much too high to squander on tourist activity for anyone other than the obscenely well-to-do.

For sightseeing surface excursions, pressurized cabins retired from Earth-Moon ferries and fitted with wheeled chassies and suitable motor units ["toads", cf. MMM # 48 SEP '91 pp. 4-6 "Lunar Hostels: Part I: Amphibious Vehicles] should be available as sleep-on go-anywhere coaches. They might be brightly colored ("Tangerine Toads"?) for safe visibility in the overly gray setting, operated by a commercial distant cousin of Greyhound (Grayspan?).

As for touring Mars, that is an altogether different set of ifs. It is unlikely there will be any sort of tourist activity out that far until tested and proven second generation nuclear rockets are available that can significantly reduce travel times and total cosmic and solar radiation exposures. First to become available will be tours to Phobos and Deimos, Mars' two close-in moonlets. These tours will feature extended observation of Mars from relatively high orbit (3,700 and 12,500 miles over the Martian surface, respectively).

However, much closer fleeting glimpses of the daylit side approaching and coming out of the aerobraking maneuver that ends the "cruise" out from Earth and puts the craft on a trajectory for either of the moons. Excursions to Mars surface itself may follow the lunar pattern, working tours first.

Is there a Lunar part in all this? Yes, to the extent that some of the vehicles, equipment, and provisions are lunar built, modifications of items first designed to bootstrap the unfolding of lunar settlement itself along with Earth-Moon trade. One thing builds upon the other — if we play our cards right, leveraging the most from every advantage. MMM

A reasonable man adapts himself to the conditions that surround him.

An unreasonable man adapts the surrounding conditions to himself.

All progress depends on the unreasonable man.



COSMOTIVE INC. By Peter Kokh

Fuels Division

Most brainstormed Lunar Development Scenarios call for earliest possible **Oxygen** production. We need oxygen to make water, for atmosphere and biosphere, and as oxidizer for rocket fuel. The intent here is a) first to reduce the cost of return crew and cargo trips to orbit and back to Earth, and then b) to ship lunar oxygen to low Earth orbit cryogenic refueling depots to lower the cost of further Moonbound supply and resupply shipments from Earth, and finally c) to reduce the cost of expeditions to Mars and the asteroids.

While in water vapor, the combustion product of LOX and LH₂, there is an 8:1 mix by weight, the actual mix going in is a hydrogen enriched 6:1. So lunar oxygen cuts the cost of 6/7th of the fuel mass. How can we do better?

An early and still often mentioned proposal is to use the hydrogen imported to the Moon to best advantage by first combining it with local silicon to make liquid **Silane** SiH₄ (a nominal analog of methane) and use that instead of hydrogen as fuel. While Silane is less potent than LH₂, its use promises to reduce the freight bill of sustaining the outpost or settlement by a significant enough percentage to be worth pursuing once the demand justifies the cost of required capital equipment. In the Silane family are other potential liquid fuels, some of which should work even better, such as Si₂H₈.

MMM Theme Issues: The Lunar Economy - Years 1-25 Dec 1986 - Nov 2011

Are there other potential totally indigenous lunar fuel combinations? In theory, yes! Oxygen has a high enough affinity for Iron, Aluminum, Calcium, and Magnesium (all rather abundant in lunar soils) to make good fuel combinations — on paper. Most discussed are Iron, which exists in handy abundance as powdered fines, and Aluminum, which, alloyed with 25% Calcium, makes a very friable easily powdered alloy.

However, we have yet to engineer a [chemical] rocket engine that can use such fuels. It's not a matter of engineering difficulty so much as the fact of life that in none of NASA's scenarios is there more than token lunar development. Thus there is not enough perceived need to justify the expense of R&D on such fuel combinations and the motors to burn them.

Those of us interested in seeing tumble the "NASA Wall" that prevents opening the space frontier to the general public (as opposed to token elite proxies for voyeuristic gratification) need to find and/or encourage entrepreneurial development of such transportation modes. Even if cheap access to space (CATS) is realized in the Delta Clipper program, the cost of shipment of goods into and out of the lunar gravity well will remain higher than it needs to be without the development of refueling options using "all lunar" fuels.

Once all the fuel needed to refuel a rocket bound for the Moon in low Earth orbit is produced locally on the Moon, the settlement's net bill for shipping and freight costs for needed imports the rest of the way from LEO to the Moon becomes moot. Not only will it be cheaper to import, but the fuel overhead cost of exporting will fall, increasing whatever competitive advantages that might already exist.

Hold & Hull Division

As we've hinted, space pioneers ought not to rest content with diversification of production for export and with maximizing market opportunities. They can improve their competitive position by paying themselves for the freight bill of both imports and exports. Using lunar-sourced fuels at every opportunity is just one part of this effort. Locally supplying as much as possible of the containers and vehicles used in import and export shipments will boost savings even further on items already competitive, and may make the competitive difference for other items marginally short of being so.

The idea of a Lunar Frontier Aerospace Industry will elicit gaffs of laughter from many. But recall the MUS/cle paradigm for lunar industrialization that we've previously recommended. [MMM # 18 SEP '88 pp. 3-4 "Lunar Industrial MUS/cle", and MMM # 65 MAY '93 pp. 7-8 "The Fast Road to Lunar Industrial MUS/cle and the Substitution Game"]. It is an "appropriate" lunar aerospace industry we are advocating.

Lunar industry should not concern itself with those complex, lightweight, and electronic ("cle") components which require a sophisticated industrial base to manufacture and which can be made on, and shipped from Earth relatively cheaply. Instead, frontier industrialists should concentrate on the more massive, unitary, and simple ("MUS") components. These are items that would otherwise cost a lot to import because of their aggregate weight, but which can easily enough be made in the settlement's startup industrial shops.

What is needed is a glass composites industry to start off production of tanks, body panels, spars and truss frame members, etc. Second generation industries using local iron, magnesium, titanium, and aluminum can expand the selection of aerospace products it is possible to fabricate locally.

We are talking about:

- ✓ **fuel tanks** both for depots and on ship,
- ✓ unpressurized **cargo holds**
- ✓ pressurized **crew compartment hulls**
- ✓ **aerobrake shields**
- ✓ **truss frame members**, etc.
- ✓ many other lesser parts that "all add up".

MMM Theme Issues: The Lunar Economy - Years 1-25 Dec 1986 - Nov 2011

A Lunar aerospace manufacturer could make these components and then assemble them with imported “works” cartridges (e.g. electronics such as navigation, control, and communications consoles, engines etc.) and slip-in harnesses etc. to make complete ready-to-fly craft.

Going one step further, here is no reason why Lunar industry could not make drone **Lifting body hulls** so that exports to Earth’s surface could fly nonstop from the Lunar surface aboard one way space craft the majority of whose mass was manufactured there. There is precedent aplenty for such divided manufacturing. Martin Marietta, for example, maker of the Titan rocket, only makes the rocket casings, and then mates them with engines and other components made by other firms like Rocketdyne.

And as for more sophisticated space hardware? Why couldn’t lunar owned & operated **salvage companies** retrieve derelict satellites and other largely intact space hardware for rebuilding in lunar shops, and eventual reflight and reassignment?. Why accept preconceived limits? MMM

MMM # 77 July 1994

Homestead Furnishings & Decor **Cottage Industry**

As we suggested in MMM # 75, one of the reasons to build settler homesteads in a generously pre-expanded form, (the concept of the Great Home) is to allow room within for the birth of cottage industries. In the early settlement period, the worktime services of almost everyone will be needed to support the biosphere (food production, recycling, etc.), export trade, and manufacture of basic needs (shelter, some basic furnishings, “issue” clothing, etc.). The need to reach real economic break-even and then go on to economic profitability i.e. a positive trade balance with Earth, as soon as possible, will be the governing fact of life for a long time. To the extent that this condition still prevails, the only labor available for the creation and production of “luxury” items, from personal touch clothing to customized furniture and art- and craft-rich furnishings will be the spare time after hours of those who have both talent, leftover energy, and the entrepreneurial soul.

This activity deserves to be supported because the morale of everyone stands to benefit. One way to effect this would be for the settlement government to “subsidize” the import of special needed tools to be owned by cooperatives of artists and craftspeople on a time-share basis. The individual cooperatives, or even a union of cooperatives, could schedule training classes in tools, materials, methods, marketing, joint ventures, etc. A publicly owned complete library of terrestrial folk and ethnic arts and crafts of all types would serve the settlement well. For many such historic arts and crafts may prove to be inspiring models of resourcefulness.

_____Once a “University of Luna” has been established, an Extension Service to Cottage Industries ought to be an early priority. For today’s cottage industry serving local needs may someday grow and evolve into tomorrow’s exporter. Surely such cottage industry will be a prime wellspring of economic and industrial diversification.

This is not to ignore the harsh fact that the transition from home-nested spare-time money-making hobby into a true independent small business is difficult and fraught with risk. Again, government and university services should be available to help those willing to take the plunge. Others will be content to continue operating as a part-time at-home hobby for fun and spare change, and they should not be discouraged. MMM

MMM # 88 September 1995

Going Back with Entertainment \$\$



Profits from accessing space-based energy and lunar resources are far off. Can feeding the entertainment appetite provide a big enough, early enough return-on-investment [ROI] to economically “terrace” an initial manned return to the Moon and a starter base?

ROYal ROAD TO SPACE By Peter Kokh

That’s the idea of the Lunar Resources Company of Houston Texas, and CEO Greg Bennett. Bennett wants to see us return to the Moon, “the sooner the better”, to develop the resources there and establish a two-world economy. Yet turning the first buck of profit from such a venture seems to everyone who has looked at the problem, a long ways down the road. So how do we attract investment capital? That comes down to asking, how can we provide an earlier return on investment?

Others have suggested “terracing” our way back to the Moon. LunaCorp’s project to put a pair of video-cam-equipped rovers on the Moon near the Apollo 11 site and have them take lots of footage on a 6-week-long long overland trek to the Apollo 17 site, could be the first terrace. Film footage would be available to virtual reality players, for a fee, at theme parks.

Entertainment ventures are financed by the expectation of fairly quick profits, not from industrialists and manufacturers, but from couch potatoes, the very people who are often most maligned as standing in the way of the future. It would be ironic, and fitting, if catering to their needs provided the missing interim financing link to get things going, again. Leisure dollars are certainly attractive, not being directly subject to national budget deficits or grandstanding politicians with 2-, 4-, and 6- year strains of myopia.

VR, virtual reality, is a new market, one already much bigger than the last over-hyped electronic wonder, holograms and holovision. Will expectations be realized? Will enough people find the VR experience satisfying enough to pay for it? – on a repeat basis? This remains to be seen.

The feature film industry, on the other hand, is long and well established. Moviemakers have been quick to follow where the scouts of humanity have led. They have taken us beneath the waves and up/down to the poles. Amateur filming in space began early and we had short TV “shows” done by Moonbound crews. IMAX-made documentaries with extensive footage made from the Shuttle’s payload bay, have shown millions the wonders visible from this Olympian perch. And now, “Apollo 13”, a real feature film, professionally produced and directed, has been released, much of it shot in real zero-G, courtesy of endless short takes on the KC-135 “Vomit Comet” flying one parabolic trajectory after another.

Movie budgets these days are quite large, often in the hundreds of millions of dollars. The first billion dollar picture may well be produced sometime in the next decade. Not all of that investment goes for expensive, exotic sets and blow-your-mind special effects. But enough of the extra bucks are aimed in that direction to lead us to raise the question. Where will movie making take us next? When will “filmed on location” mean “filmed in orbit” or on a loop-the-Moon flight? Not with just tag along cameras manned by specially trained astronauts, but with actual studio film crews and real full-time actors?

MMM Theme Issues: The Lunar Economy - Years 1-25 Dec 1986 - Nov 2011

Lack of reasonably priced access to space is the real hitch. It is one thing for a studio to “rent” an actually orbiting “set” such as a shuttle flight, or the Mir I complex (especially after it becomes surplus when the ISSA, the International Space Station Alpha, becomes operational). But the cost of getting crews and actors up there is currently too high.

Abracadabra “Cheap Access”, and you can picture Universal or Paramount leasing Mir I, even spending a hundred mil or so to re-outfit the decommissioned station, to serve as the set for some orbital industrial espionage thriller, maybe even involving zero-G sporting or athletic events in some future Olympics. They might even pay to add a new module or two (perhaps, with another investor, a mini-hotel wing?), especially if, after the film crews are gone, the refurbished complex can be sold or leased to some commercial concern at a price that justifies the additional investment.

Will filmmakers ever take us where NASA has yet dreaded to tread? Why not? Split Mir I into two complexes joined by a winchable tether, and set the pair spinning around their common center of mass. A pair of flywheels, one at each end, could start the process and control the rate and also keep each subcomplex from twisting at the end of the tether. By carefully choosing the weight ratio and the rpms, the result could give Hollywood one “Moonbase” interior set, complete with one sixth gravity, and a “Mars base” interior set, complete with simulated three eighths gravity.

Would Hollywood ever pay for a real Moonbase made as inexpensively as possible with off-the-shelf hardware (duplicate station modules or Spacehab modules) and launched with existing cheapest available rockets? If not the whole starter base, how about an extra module or two to fit the plot of a film – ward room?, gym?, laboratory?, garage? – or a rover cabin? Perhaps they will prefer to wait for a passenger version of some Delta Clipper type* SSTO vehicle to enter service.

[* Fans of VTHL type alternatives fail to realize that winged landers are not going to be able to be refueled in orbit and go on to the Moon, whereas a VTVL tail-lander could do so.]

The odds would improve if, the film shooting over and done with, there was another commercial tenant, signed-on-the-dotted-line, to whom the new Moonbase could be turn-keyed. It would almost have to be a joint venture of some sort. But the idea of Hollywood paying half a billion towards the total cost of such a complex, or towards special features or outfitting on it – to fit the needs of the film (especially if attractive to the turn key tenant as well) is hardly absurd.

The couch potato wants to see and experience Mars for himself, not pay good tax money to send a handful of proxies there. But he wants to see it without spending months of round trip travel time or experiencing real risk and danger. Hollywood, traditional films and VR in combination, can give him what he wants. And perhaps that’s why the traditional government sponsored space program has faltered. It has sent only proxies, and, in a failure of imagination (granted the technology has not yet matured), not really tried (or even intended) to take the rest of us along as voyeurs if not as voyagers.

While producers, like anyone else in business, want to minimize costs wherever possible, there is a limit to how much they can satisfy the public with fake special effects. There is a point at which faked fractional gravity is not really convincing. The public too, may begin demanding filming “on location” once they realize that it is affordable. Even when filming on lunar location becomes feasible, as many scenes as possible will be shot on Earthside sets. Yet the points are made. The public expects more and more realism, and the money to be made from a major successful film is beginning to approach a respectable fraction of what it might take to do an off-the-shelf return, cut the bureaucratic red tape money-eating pork!

Even a “Cheap Access” SSTO vehicle will not open space for the millions – not anytime soon. Combine Cheap Access with high-tech imaging that puts the stay-at-home “on location” and you have a dynamite combination. It is clear that Hollywood and entertainment have to be a major partner of any realistic near-term human return to the Moon, and of any human

MMM Theme Issues: The Lunar Economy - Years 1-25 Dec 1986 - Nov 2011

expedition to Mars. That will be a hard pill to swallow for many professional space-involved people, but if it proves to be the only way, it is a scenario that will win out.

The second half of a 1-2 punch – Advertising

Advertising is already a hand-in-hand not-so-silent-anymore partner of Hollywood film production. Advertisers will be a collaborator on any future re-pioneered space frontier. They too have real green money to spend, and will spend it where the couch potato can best appreciate it. In a major turn-around, it is the Resource & Energy people who may be following where couch potatoes demand that Hollywood leads.

If couch potato wallet funds justify a major portion of the money needed to float a first lunar return mission, more than that will be needed to keep the “permanent” outpost alive long term. Any such Hollywood-led venture will have to have industry and commercial consultants in tow. The outpost can be designed to support initial or lead-in industrial efforts. The Moon return crew could set up and tend, for a fee, pilot and demonstration oxygen production, iron beneficiation, and other equipment. The base would have to be co-configured so as to meet a turnkey operator’s needs. Anything commercial and/or enterprising fits the scenario, and if a healthy mix of money-drawing activities is what it takes, that is what it will be. The only thing that is sure, except to the ostriches amongst us, is that the principal player will not be some government agency spending the people’s tax money for intangible benefits.

The “terracing” paradigm is still in its infancy. We can only see the sketchy outlines of a for-profit-step “terrace” here and there. We are extrapolating on faith that the profit motive can find a sequence of early return-on-investment efforts that will succeed in establishing humanity, and Gaia, securely and permanently beyond the Earth Biosphere’s atmospheric confines – the “R.O.I.al” road to space.

Is it so unthinkable that Hollywood could or would grab the lead – and not just tag along “later, when it’s safe”? Isn’t it just a case of a student or disciple growing up and becoming the teacher? Surely none of the world’s space agencies have learned how to push the public’s button. Hollywood knows how, or at least may soon be willing to gamble a well-hedged billion or so that it does.

No one is saying that entertainment can do the whole job, or that we can start lunar development with a “Six Flags Over Copernicus” theme park. What Bennett and company are saying is that perhaps, in this era when every other potential player is waiting for the other to take all the gamble and get things started, this is a job i.e. priming the pump, that entertainment and advertising dollars may be up to, and that once established, a Moon base with a commercial for-profit culture will take on a life of its own, quickly attracting multinational conglomerate developers and industrialists and energy people.

The Lunar Resources Company [TLRC] is not intimidated by commonly accepted cost projections inflated as they are by the expectation of continued NASA-business-as-usual rules of the game. **He who takes the plunge resets the rules.** It may well take a player not addicted to government money, but with plenty of experience in tapping the ultimate deep pocket, that of the couch potato.

The Artemis Project™ is TLRC’s name for its Commercial Moonbase endeavor*. At present Artemis is a trial balloon scenario using existing hardware. As new hardware comes on line, and alternate ways of getting the most out of novel combinations of existing hardware are realized, the continuing brainstorming behind this scenario is sure to advance. It is thus quite unfair to take cheap shots at Artemis on the grounds of its initial scenario.

Other criticism and skepticism centers on the real depth of the entertainment dollar fountain. But here again, since TLRC is willing to consider a mix of commercial activities and functions that will not require landing too much weight on the Moon or require too much pressurized volume to support, this criticism misses the whole point.

Space for profit is a path not yet taken, and the size of the population claiming to be from Missouri is sure to swell until success brings out of the closet the “I knew it would work all the time” sudden majority.

MMM Theme Issues: The Lunar Economy - Years 1-25 Dec 1986 - Nov 2011

But there are still those who do not yet realize that the old world order is gone forever. Public Space is dead. **MMM**

NB. The Artemis Project failed because its financial game plan was unrealistic. You cannot finance a mission on expectation of profits from infotainment products that are produced during and after the mission. Such money is a reward. The mission has to be paid for up front. Other similar plans have failed for the same reason. **PK**

“Is the Moon a wasteland?”

“There is no such thing as waste,

There are only resources we are too stupid know how to use.”

– Arthur C. Clarke – to Walter Cronkite during launch of Apollo 1

The best way to predict the future is to be busy creating it.

Prize Lunar Real Estate

Locations with special attractions other than Mineral Wealth

By Peter Kokh

Impatience carries risks

There are those so impatient to return to the Moon that they disvalue any further robotic missions designed to reveal where the richest and most accessible resources lie as “money sink distractions”. Yet, to reduce the chances of the first human outpost becoming a ghost town in unseemly short order, the careful selection of a site especially capable of supporting viable economic activity is hardly unimportant. Rather it is impatience that needs to be dismissed. Impatience always backfires. That’s a Cosmic Law. There is no point in deliberately blindfolding ourselves and playing “Pin the Tail on the Donkey” with a Moon map as some apparently want to do.

The tasks of a First Outpost

At the same time, it is possible to argue that any good site will do to demonstrate the viability of a permanent human presence on the Moon. The task of such a beachhead is to survive the 14.75 Earth day–long dayspans and nightspans, the heat and the cold, the radiation and solar storms and micrometeorite rain, the absence of a biosphere rich in organics and volatiles. Next the aim is to begin demonstrating an ability to use the resources that are common on the Moon to provide some continuing support and a respectable part of the wherewithal to expand.

Distribution of Lunar Resources

The Moon’s major resources (oxygen, silicon, iron, aluminum, calcium, titanium, and magnesium) are distributed rather homogeneously (relative to their very uneven redistribution on Earth). So, the argument goes, we can always pick a second more advantageous site to begin industrial settlement in earnest. Indeed, one might argue, the lessons learned in the initial demonstrator outpost might warrant a fresh start elsewhere, rather than expand upon the trial and error dawn base.

While there is certainly merit to this argument, it is also likely that whether those planning and going on to deploy the first base care or not, additional robotic resource–finding missions are likely to be flown before the first outpost can be erected. In that case, it would be foolish not to take into consideration the knowledge those probes supply.

The relative advantages of some sites over others calls for careful consideration – “coastal” sites

MMM Theme Issues: The Lunar Economy - Years 1-25 Dec 1986 - Nov 2011

Some general considerations can be made now. Both from a resource using and a tourist/film-making point of view, it would be stupid to locate the outpost either in the middle of crater-pocked highland terrain, or in the middle of the much flatter maria terrain — when by picking a “coastal” site the mineral and scenic diversity of both (highland and “sea”) are present. Happily, innumerable sites fit this requirement.

Early Iron Extraction and Production

If early industrial activity beyond oxygen extraction is likely to center on iron as the easiest element to extract and produce, we already have fair evidence of extensive areas that fit the bill. We’d be suicidally foolish to locate elsewhere.

Public Awareness Potential

Another point of convergence is maximizing public interest and awareness. This should be important both to those who would like to see a government Moonbase (in the mold of Antarctica’s McMurdo Sound) and those who would like to see a civilian commercial outpost (like most every for real burg on Earth). One sure way of doing this is to locate the base in an area that can easily be identified by the trained naked eye, or at least in binoculars. Perhaps others in the habit of studying the Moon with the naked eye might not concur, but the feature I find easiest to locate at all phases of the Moon visible in early to middle night hours is the Sea of Crises, Mare Crisium, to the north east of center. This oval Mare, the size of Wisconsin and Upper Michigan together, is clearly distinct from the “chain of seas” that run into each other: Fertility, Tranquility, Serenity, Rains, the Ocean of Storms, etc. I am aware of no one else who is partial to Crisium. Other proposed locations in Fertility, Tranquility, Serenity, Imbrium, the crater Alphonsus etc. can be picked out by the trained eye easily enough in binoculars, but that makes them unidentifiable for the masses. Anyone can learn to spot Crisium immediately. Somewhere along the shore of Mare Crisium, along the highlands separating it from Mare Tranquilitatis or Mare Fecunditatis could make a fair site. Of course, this is only one consideration and must be weighed along with others.

Dayspan naked eye identifiability is not the only PR trick that promises to build public awareness. A nightspan beacon near the outpost, beaming enough lumens Earthward to be clearly picked out, would certainly command much more attention. This would suggest placing the outpost in a part of the Moon that is usually not illuminated when the Moon is above the horizon in early evening hours – in other words, well into the western hemisphere (coastal/shore areas of western Oceanus Procellarum, the Ocean of Storms, or in the Aristarchus area for example). In contrast, a beacon in any of the eastern seas (Tranquility, Fertility, Crisium, etc.) would not be visible until the waning (post full) Moon that rises later in the evening and would be noticed by far fewer people.

Improved vs. Unimproved Sites

On Earth we distinguish between improved and unimproved sites. The later lack electrical and water utility access. But even unimproved sites on Earth have atmosphere and access to at least some rain. No site on the Moon has as much, every lunar site being radically unimproved.

Shade

Yet some sites have assets, beyond minerals, that other sites do not, such as appreciable part-time (and rarely, full time) shade. This can be important in planning thermal equilibrium maintenance with the placement of heat rejecting radiators etc. Rille walls and crater walls and escarpments all provide part time shade depending on the local path of the Sun across the sky. In general such minimally improved sites are scattered everywhere, but are the more densely located the nearer to the poles where the maximum elevation of the Sun over the equatorward horizon is lower. This would seem to directly compete with the landing/take off economy of equatorial sites. But keep in mind, with the Moon’s lethargic rate of rotation, the touted desirability of equatorial sites is grossly exaggerated.

“Lee” Vacuum — Lavatubes

MMM Theme Issues: The Lunar Economy - Years 1-25 Dec 1986 - Nov 2011

More significant an asset than shade is true “lee” vacuum, where there are surfaces never exposed to the lunar sky, and thus always protected from cosmic radiation, solar ultraviolet, solar storms, and the micro-meteorite rain as well as wild day-night sunshine-shade temperature swings. Such areas will be ideal for warehousing and garage space and unpressurized industrial operations. They exist underground.

The Moon has no limestone caves made by running and dripping water. But it does have lavatubes on the order of many tens of meters wide and high, many tens of kilometers long. These substantial lee voids are currently known only from indirect, yet indisputable evidence. Winding valleys, aka sinuous rilles, are a related feature, made from rivers of very fluid lava. Many rille valleys have bridged sections that suggests the visible valleys are near-surface lava tubes with collapsed roofs and that the “bridges” are intact tube sections.

Elsewhere we see winding chains of rimless craters that can only be collapse pits where parts of a largely intact lava tube below have fallen in. The inference is that elsewhere, there are wholly uncollapsed lavatubes. As the mare basin-filling lava sheets were laid down in distinct episodes with lava tubes likely forming in each layer, there may be many intact lavatubes well below the surface layers in some lunar seas.

Where are these lavatubes and their “lee vacuum” to be found? In the maria, mostly near coastal areas! While we are a long way from identifying all such features, we can locate a base in a coastal region with partially collapsed rilles in the likelihood of finding usable intact tube sections nearby.

Interregional travel considerations

Quite a different consideration is ease of surface trans-port between a base site and other major areas of the Moon with comparable assets. A coastal site on one of the “chain” of mare basins on the Nearside seems best (leaving out Crisium and other highland-locked seas). On Earth some locations seem born to host major towns. To give a few examples, straights and narrows (Singapore, Detroit), major river confluences (St. Louis, Pittsburgh, Wuhan), major harbors (San Francisco, Rio de Janeiro, New York), lakeheads (Duluth), lake ends (Buffalo) and interlake constrictions (Niagara Falls), places where water routes and overland routes converge (Chicago) etc.

Now on the Moon, we have no bodies of water or waterways. But we do have a chain of Seas or maria across which the going is easier – at least in general. Here and there on the maria, lava flow front scarps and rilles and occasional craters block arrow-straight travel, forcing bypasses. Places where such obstacle negotiation becomes easier recommend themselves as strategic sites. Coastal highland promontories and headlands (e.g. the cusps of Sinus Iridium in NW Mare Imbrium) are also route narrowing spots. There are “straights” and channels through which traffic must move, like the Alpine Valley that links northern Mare Imbrium and Mare Frigoris.

Craters with breached walls have interior assets more easily accessible than those of others. Passes through scarps and mountain chains also lure the town planners. Similarly, if highland-locked seas seem to include otherwise desirable townsites, there will be spots along their coasts from which a route through adjoining highland areas may be relatively easier to negotiate. Such spots too would claim attention.

A VERY CRUDE “MAP” OF NEARSIDE

MMM Theme Issues: The Lunar Economy - Years 1-25 Dec 1986 - Nov 2011

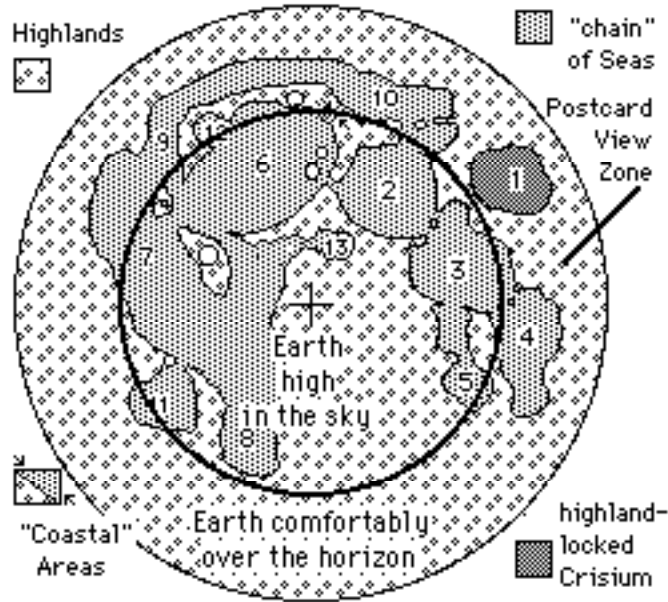

- KEY:**
- 1 Mare Crisium, Sea of Crises
 - 2 Mare Serenitatis, Sea of Serenity
 - 3 Mare Tranquilitatis, Sea of Tranquility
 - 4 Mare Fecunditatis, Sea of Fertility
 - 5 Mare Nectaris, Sea of Nectar
 - 6 Mare Imbrium, Sea of Rains
 - 7 Oceanus Procellarum, Ocean of Storms
 - 8 Mare Nubium, Sea of Clouds
 - 9 Sinus Roris, Bay of Dew
 - 10 Mare Frigoris, Sea of Cold
 - 11 Mare Humorom, Sea of Moisture
 - 12 Sinus Iridium, Bay of Rainbows
 - 13 Mare Vaporum, Sea of Vapors

The Alpine Valley between (6) and (10) lies between the arrows.

Summary

One site is not “just as good as” any other – except to one grossly unfamiliar with the Moon. We could know more than we know today before making a final selection. But if we carefully weigh all we now know about variously advantaged locations, we can pick a good site viable long term, even if the main thrust of industrial lunar activity occurs elsewhere.

It is perhaps decades too early to tell whether some twist in lunar development will add a strong tilt to this or that location, perhaps even despite a low score on the test points above. A “go” for Lunar Solar Power Arrays on the E & W equatorial limbs would be one such all-bets-off eventuality.

Eventually there are sure to be a good plurality of developing settlement sites around the Moon. Our point then, is not to be sure to pick the very best site for the first outpost, but just to pick a site good enough to remain actively occupied well into the future. We need to take the task seriously, but not so seriously that we lose sleep agonizing over it. **MMM**

"No grimmer fate can be imagined
 than that of humans, possessed of god like powers,
 confined to one single fragile world." -- Kraft Ehrlicke

From the MMM Dictionary  Entry — “Commercial Space”

“Any for-profit endeavor or enterprise, which increases the amount, scope, feasibility, and/or sustainable economic viability of robotic and/or human presence in Earth orbit and beyond”

One might get the idea from many space activists that commercial space means private launch companies and small satellite manufacturers – only! Even if this is qualified with an “at this stage of the game” this short list betrays a troubling lack of imagination, coming as it does, from people who say they want to live somewhere other than on Earth!

While it may be easier, and safer, to restrict one’s ambitions to the “toy space” of microsats and small launchers, our goal is to create a self-sustaining human economy beyond Earth’s atmosphere. This clearly requires **commercial entry into man-rated rockets and habitat hardware**. This has already begun. The for-profit SpaceHab shuttle payload bay module is already a reality, but has faced a rocky road.

Early plans for commercial tourist modules were ill-fated because they depended either on paper study spacecraft, or upon the government owned shuttle. Any effort to piggyback commercial for-profit activity on profit-be-damned agency programs is at the mercy of political pressures and bureaucratic procedures — hardly a place to put dearly acquired capital.

Many put all their hopes on the X-33 program. But the dream of **Cheap Access** from NASA seems troublingly self-deceptive. Meanwhile, would-be commercial players stall.

We clearly need **commercial manned access** to space. Yet the very presence of the shuttle system works in a highly preemptive manner to prevent such access from materializing. What is needed is to tie in with **a commercial manned destination**: a commercial space station. With the adoption for the International Space Station Alpha of the high inclination orbit favored by the Russians, there has never been more reason than now for an alternative, a commercial station-depot in a low inclination orbit vastly superior as a staging and refueling place for deep space missions. Alpha would serve Moon and Mars missions at a severe handicap in comparison. There will also be need in orbit for more lab space at commercial disposal than ISSA can or will provide.

We also need to dust off the “**Space Cartage Act**” proposed many years ago whereby anything once in orbit and without its own motive power, could be moved to another space location or orbit only by a commercial vehicle.

Yet there is another kind of entrepreneurial activity that has the potential to accelerate the realization of an open space frontier. It is not at the mercy of bureaucratic, administrative, or congressional whim. Why not? Simply because it is a path that does not threaten powerful vested interests. We are talking about “**spin up**” **research & development**.

“Spin up” works like this. The entrepreneur considers the many and varied technologies that will someday be needed on the space frontier. Next he/she considers what profitable terrestrial applications there may be for each of these. There follows a business plan, and ultimately a for-profit terrestrial enterprise which has the happy effect of pre-developing and debugging and putting “on the shelf” a technology which will one day help open the frontier – sooner and at less cost. **MMM**

NOTE: For new and/or unfamiliar terms used in MMM, consult the MMM Glossary at:

<http://www.moonsociety.org/publications/m3glossary.html>

“The difficult we do immediately. The impossible takes a little longer.”

Army Corps of Engineers

Failures are the raw materials out of which success is forged.

A project that isn’t difficult, is probably not worth doing!

Commercial Moonbase Brainstorming Workshop

COMMERCIAL MOONBASE BRAINSTORMING WORKSHOP

Report by Peter Kokh, First Contact II Co-chair

On October 7th, 1995, at a Science/Science Fiction Convention in Milwaukee, **First Contact II**, the (Milwaukee) Lunar Reclamation Society (NSS) hosted a 3-hour brainstorming workshop on the "Design Requirements for a Commercial Moon Base". The Lunar Reclamation Society (NSS-Milwaukee) and Milwaukee Science Fiction Services are joint partners in this new hybrid convention. Leading the workshop was the special LRS "Doer" Guest of Honor, **Greg Bennett**, CEO of The Lunar Resources Company in Houston, and chief architect of "The Artemis Project"™. Co directing the session were Mark Kaehny and Peter Kokh of LRS. David Burkhead of Spacecub fame also participated. There were eleven of us altogether.

After a few general remarks about what we were going to attempt to do, **identify things a first lunar outpost could do to make money**, we broke up into two brainstorming groups (larger groups are unwieldy).



Group A: Greg Bennett, Mark Kaehny (group secretary), David Burkhead, Edwin Reck, and Mark Roth/ Whitworth — came up with the suggestions below.

>> The numbering reflects only the order in which the suggestion was made – given the limited time, there was no attempt to put these ideas in a logical order, much less to come up with them in a logical order – brain-storming, by its very nature, has to be free-ranging and unfettered. The inevitable chaff can be separated out from the wheat later. The dynamics of group brainstorming is such that an idea presented "half-baked" by one person, can then be "fully baked" by others in the group. It is an exciting process.

>> The contents in square brackets, [], are added by the MMM editor, a non-participant in Group A, and may or may not accurately qualify or reflect the intent of the suggestor.

1. (a) CD-ROM "Artemis Story", (b) full video interactive 3-D animation videotape with celebrity speakers. – [from Ed Reck]
2. Sell rides on training equipment similar to Rand Simberg's Space Lines. Actual training.
3. Photo CD-ROMs pictures. Documented Travelogs, National Geographic style.
4. An online WWW pay-for-data site.
5. Animé – Japanese Animation – CD-ROM, magazine story.
6. Licensing the Setting i.e. of "the Artemis Universe"
(6a) Creating "Artemis" Product Line Children's toys.
7. Scientific sponsorship – rack space and crew time, paid for by corporations as good will advertising
8. Hardware junkie big name contacts" – Bill Gates?
9. Flight Models – Estes type static models and mockups [for sale to theme parks, air and space museums etc.]
10. Babylon 5 newsgroups – meet people – Staszynski etc.
11. Sell Lunar Samples, Made on Moon scientific novelties
12. Sell [lunar regolith] simulants and scientific novelties
13. Television Story – Shows on all possible variations on "nationality of the Moon"
14. Solar Power Demonstration – small power satellite
15. "Save the Earth" – sell concern for Earth's future

MMM Theme Issues: The Lunar Economy - Years 1-25 Dec 1986 - Nov 2011

16. Sponsoring Conferences – make money off of fame, leverage off fame (credibility problems?)
17. Sponsorship of Companies – “Proud Sponsor of ...”
18. Sell bricks made from lunar regolith simulant
19. (a) Selling place names on the Moon [of small features to be named after donor etc.] (b) Selling burial plots on Moon [for lightweight cremation ashes.]
20. Long term storage in cold rad-sheltered vacuum: sperm and egg bank; biological and pathogen samples; archival space for data and knowledge stored on magnetic media; etc.
21. (a) Robotic Probe – B/W 10 frames/sec. [illustration below]

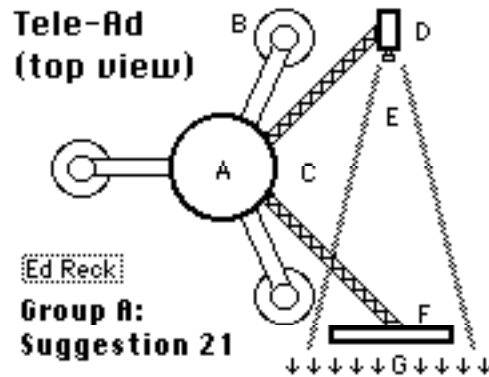

KEY: A. Lander core with power and communications package; B. One of three landing pads; C. retractable booms; D. videocam; E. Videocam's field of view; F. Electronic message board tele-changed from Earth; G. Background scenery.

- Another idea was to draw messages on sand with a stick, and photograph these. [anything from ads to expensive but cherished Valentine Day "I love you" cards – authenticated.]
- (b) Signs on the Moon whose message can be telechanged from Earth, with image of sign in lunar setting transmitted to Earth – i.e. real time unobtrusive advertising on the Moon.
 22. High Definition digital video [the Artemis Story, etc.]
 23. TV produced on Moon. Aerobics, Kick Boxing and Karate, [and the obvious bootleg videos which must remain rumored.]
 24. Selling 1/6th g rides on counterweighted gym sets [such as the Mars-grav weight compensating gym set made by Ann Arbor Space Society]
 25. Sports Programs [uniquely lunar sports that do not need a lot of pressurized volume – with fast, neat action and high spectator value – direct pay-for-view broadcasting to Earth]
 26. Maps of Moonbase area [wall murals, placemats, anyone?]
 27. [Static] Models and working models
 28. [Merchandising mail order] Catalog of cool space stuff
 29. Pay to work schemes [like architectural and paleontological "digs"] Hands on patronage. Field Trips. Sponsored trips [can be to terrestrial sites where neat preparation and simulation things are happening]
 30. A newsletter "Holidays on the Moon" published when morning comes to the proposed settlement site [i.e. "moonthly"]
 31. Medallions – [individualized] matching set – one sent to the Moon. You keep the other one.
 32. Mission Control Center for the Artemis landing missions to be located in a Theme Park [pay-to-observe]
 33. Coin-operated games; your face in a cool Moonbase setting
 34. Limited Edition Prints, signed by artists, countersigned by the first return crew – e.g. famed artists like Kim Poor

MMM Theme Issues: The Lunar Economy - Years 1-25 Dec 1986 - Nov 2011

35. Mural Pictures [Murals are scenic wall papers 4 large pieces across the top and 4 across the bottom, not pre-pasted. Environmental Graphics of the Twin Cities is top manufacturer of nearly 2 dozen scenes which sell for \$40-50 and include Earth over Apollo 17 landing site, Columbia in orbit over cloud-studded Earth, and Saturn and its moons]
36. Space-wear and Moon-wear clothing for Ken, Barbie dolls.



Group B: Peter Kokh (group secretary), Fred Oesau, David Crawford, Doug Seitz, Jim Plaxco, and Kevin Crowley.

>> Whereas Group A concentrated (not exclusively) on money generating ideas to get the Artemis Project “on the way”, Group B chose to concentrate (again not exclusively) on money generating ideas that would apply “once a permanent occupiable outpost was set up”

1. **Testing/tending** of prototype feasibility demonstration **equipment** for mining operations, beneficiation processes, other processing: e.g. lunar oxygen production, silane [silicon-based analog of methane] fuel production; iron fine extraction and sintered iron product manufacturing; i.e. Artemis crew-members serve as time-share mission specialists for companies hoping to do industrial business on the Moon.

Money would be earned not only from providing time-share trained labor. Income would also be generated by carrying along equipment to the Moon, shipping back various processed and manufactured samples, etc. i.e. renting payload space and mass aboard the Lunar Transfer Vehicle, and descent/ ascent vehicles.

2. **On site Advertising.** More elaborate possibilities than in # 21 above because of the availability of crew for non-electronic changeouts, as well as part time models, actors, etc. The availability of crew also permits greater latitude in changing the all-important background setting, i.e. in total picture composition. It allows moving “commercials” as well.
3. **Setting up and Tending Telescopes** and other astronomical installations (changeout of instrumentation) for university-consortia etc. This would involve trained time share crew as mission specialists, and fees for payload bay space and weight as in # 1, above.
4. **Teleoperated “Working” Robot-Rovers** – Artemis sells **minutes/hours** for the right to teleoperate mobile equipment that (a) emplaces regolith shielding over the habitat complex; (b) grades approaches and aprons, improved landing pad, etc.; (c) collects dust and rocket samples.

Time could be purchased directly, or, seeing that it would be expensive and eliminate all but the best-heeled of individuals, corporate sponsors (or Artemis itself) could raffle off the right to teleoperate such equipment, after a minimum number of hours of simulation training, of course, this included in the package, so that the actual time would be well spent, both to reward the lucky individual teleoperator, and to maximize for Artemis the efficiency and safety with which the needed work gets done.

This concept would not be unlike going on a paid “teleoperated” archeological or paleontological “dig”.

5. We **noted** that many income opportunities will presuppose that Artemis planners had picked a **visually exciting site** with its surroundings, not just a scientifically exciting one.
6. **Photograph panoramas** deserving of being rendered as **wall murals** (wallpaper, see #, Group A, above). This will include one of the Artemis Moonbase itself, either/both as under construction or/and as completed (phase 1), as well as various untransformed scenic vistas in the area.

Some of these murals could be available for open reproduction, others sold in limited sets of 100 to generate high individual auction/bid prices.

7. **Telerobotic lessons** sold separately to qualify winners of teleoperation time. See # 4, above.
8. **\$100 million lottery** – winner to be trained as time-share mission specialist along on the first, or second mission.

MMM Theme Issues: The Lunar Economy - Years 1-25 Dec 1986 - Nov 2011

9. **Teleoperable manufacturing equipment** to be engineered by rival competing engineering teams pro bono – the carrot reward being the right to get a percentage return or royalty on income generated by the teleoperated device for the its operational lifetime.
10. **Entertainment pay-per-view TV produced on site**, capitalizing on eerie effects of 1/6th gravity: one or two person ballet performances (doable on a small set); midget sumo wrestling (our apologies to the Little People or those of Japanese descent to whom our fun suggestion is offensive); once a bigger “gym” is available, Lunar Jai Alai.
11. **Made, or hand-selected on Moon artifacts**, coins, jewelry. Cut and polished breccia broaches or ring stones. Sintered iron coins to be polymer coated against rust on arrival on Earth. Items made of glass spherules. Necklace glass capsules half-filled with common regolith Moon dust.

Weightier and thus much more expensive: sinter-cast block which bears your own footprints, made on the Moon with a casting or your very own foot/feet or shoe(s)/boot(s). Sinter-cast blocks with custom valentine-type message.
12. **Selling Names:** of modules and parts of modules of the outpost and lunar descent vehicle. e.g. the John Doe porthole, the Jane Doe Hall (meetings, TV studio, dance hall, gym, Jai Alai court, etc. etc. multi-use larger volume hard hull module or inflatable.

Also getting corporations to pay for additional mods or upgraded interiors of planned modules – all for the ad value = e.g. “furnished by Apollo interiors, of city, state.”
13. **Repository for cremation ashes.** This can be under the open star-spangled sky, UV-protected by a quartz pane.
14. **Biological Quarantine Facility** for sample all-but-extinct pathogens and toxins too dangerous to be kept indefinitely at the Contagious Disease Control Center in Atlanta. An associated lab could be a follow-on.
15. **3D computer-controlled variable mold stamping** device which will render your footprints/handprints and a photo of same on the Moon, in an area to be set aside not ever to be re-disturbed . Different from # 11 (second paragraph) above.
16. **Lunar Spaceport Beacon** which can flash messages (commercial ad or personal [monitored] for a high fee) in Morse code when visible from Earth during local Moonbase nightspan. [see MMM # 89, OCT '95, page 1 bottom]
17. Along the same line, experiments in local nightspan **fireworks and light shows** to be paid for by sponsors on Earth for very large terrestrial audiences on special occasions.
18. Afterthought on # 11 **jewelry** ideas above. For necklaces, glass spheres with actual lunar vacuum (glass is stronger under compression)
19. **Actual Signatures on the Moon:** Artemis would sell the right (and small space) to write/ engrave your signature on various pieces of structural or operating hardware(a) to land temporarily on the Moon = cheaper, or (b) be part of the perm-anent outpost installation. This idea is attractive because it does not add to the weight or cost of the hardware to be landed on the Moon. A much less expensive option (c) would be to take along your signature in microfiche or electronic form.

Reflections on the Workshop

As I had guaranteed Greg Bennett as we were about to start, this process was sure to come up with many ideas that have already been thought of in previous Artemis Project brainstorming sessions, but also certain to come up with some new ideas previous groups had not thought of, or at least new variations. Afterwards, Greg assured me that the Workshop had delivered as promised. All participants found the exercise very stimulating and the high point of their convention.

In Houston and in Huntsville, the ideas outlined above will be merged with the results of previous marketing and income generating brainstorm sessions. ###

MMM # 116 June 1998

URANIUM & THORIUM

Politics, not Economics, may force the birth
of an early Nuclear Fuel Industry on the Moon.
The “no-alternatives” stakes are considerable:

- Radioisotope Thermal Generators for Probes
- Electric Power Generation Plants for Moonbases
- Nuclear Rockets to open Mars as a Frontier

[Since January, 1998, **Lunar Prospector** has been busy mapping areas richer in both elements]

By Peter Kokh

IN THE WAKE OF CASSINI

The grass roots efforts to stop the launch of the Plutonium-RTG powered Cassini spacecraft bound for a 2004 encounter with Saturn and its great moon Titan, were unsuccessful. But they had enough of an impact on the media and the powers that be, that it would be surprising if a U.S. congressional ban, if not a ban enshrined in some global space treaty, forever banned the sending of activated nuclear fuels through the atmosphere, were not enacted or ratified in the near future, as the case may be.

For those of us who realize how nearly indispensable nuclear thermal generators, nuclear power generation plants, and nuclear rockets will be for continued exploration of the outer Solar System, and for manned installations and eventual industrialization on the Moon and Mars and elsewhere, this likely embargo presents a challenge that demands we rise to the full capacity of our brainstorming talents.

The hook upon which a practical workaround might be hung is that the embargo will likely be only of active nuclear fuel and nuclear fueled plants and engines. We should still be able to launch **unfueled** RTGs, nuclear power generation plants, and nuclear engines for rockets into space. As these fuel-using devices are more complex to manufacture than the prospective fuel itself, that is a very encouraging foot-in-the-door for those of us undaunted enough to dare open it after it has apparently been slammed in our face with a very finalistic sounding thud.

Two questions now pose themselves:

- Can we find suitable radioactive elements out there from which to make nuclear fuels beyond Earth's atmosphere? **YES!** — on both the Moon and Mars, and probably on some asteroids.
- Can we do the engineering to mine and process source radioactive elements into nuclear fuel out there?

YES! — and with non-nuclear byproducts for diversifying lunar and Martian industries.

The nodule of the interstellar gas and dust cloud out of which the Sun and its planets formed had been well-doped with radioactive elements by the many nova explosions that had nourished it. They are a significant portion of Earth's crust, where their combined heat output over time has been enough to turn the mantle into molten magma. It is that heat that drives plate tectonics, continental drift, and vents itself in volcanoes. We can expect the same of any silicate world (includes Mercury, Venus, Moon, Mars as well as Earth, and the major Jovian moons.)

LUNAR & MARTIAN ELECTRIC POWER NEEDS

We do not want to be restricted from further exploration of the outer Solar System by our probe spacecraft. But of much greater economic significance is the need for reliable power for manned installations on the Moon and Mars.

MMM Theme Issues: The Lunar Economy - Years 1-25 Dec 1986 - Nov 2011

On the Moon, where twice the solar power flux per square unit of surface is available as on Mars, unavailability of “nukes” would be a blow, but not a fatal one. Solar power is quite practical for dayspan operations and uses, nor is there a problem producing a surplus. And there are several ways to store that power for nightspan use – none of them without challenging drawbacks — more to the point, none of them with showstoppers.

To make the problem easier, some considerable fraction of outpost and industry operations may be sequentially separable into more power-intensive and less power-intensive tasks, to be dispatched in a rhythm that works with the natural lunar dayspan-nightspace cycle, the “sunth”. We can “do the Moon” without nukes, at least for nearer term beachhead establishment. That is encouraging.

Still, there will be industries and operations using equipment too dearly brought to the Moon to be allowed to lay idle half the available time, operations that need “full” power at all times. And once we begin building industrial and warehouse parks in cavernous subsurface lavatubes, nukes will be even more convenient. Long term, if not short term, we need nuclear power, fission or fusion, on the Moon.

On Mars, solar power will be much less efficient and convenient, and occasional long-lasting global dust storms could pose a serious problem for any operation relying on solar without backup. Even before the first humans arrive, we will need nuclear thermal power to process rocket fuel for return-to-Earth flights. And the established availability of ready-to-use power on Mars, will make the prospect of sending the first human crews on an unabortable 2-3 year mission a lot less odds-tempting.

THE LIMITS OF CHEMICAL ROCKETS

As we’ve pointed out before [MMM # 112 FEB ‘98, “In Focus: Cassini En Route: Time for Applause, Time for Pause” pp. 1-3] we may succeed in sending exploratory crews to Mars with chemical rockets. But we will be pushing this propulsion technology to the practical limits in doing so. Not only will chemical rockets never take humans out to the main Asteroid Belt or to Jupiter’s great moons and beyond, but they are unsuitable as workhorses to open the Martian Frontier to droves of Earth-forsaking settlers and developers. They are just too slow, offering one way trip times of 6 to nine months. This is not the 16th century. People of today will not care that their ancestors once spent comparable time crossing the Atlantic. More importantly, exposure to cosmic radiation over such time periods is not trivial.

Robert Zubrin’s scenarios for opening Mars to settlement, as do others’, depend on the availability of nuclear powered spacecraft. If we can build them but not get them into space, that is a problem. The acceptance of the engineering challenges posed by the workaround suggested above is vital. We make it work! Or we watch our Martian dreams go poof!

WHAT LUNAR PROSPECTOR HAS FOUND

Previously, the Apollo 15 and 16 Command Modules, staying in lunar orbit during the landing mission, carried a Gamma Ray Spectrometer for the first crude chemical mapping of the Moon, at least of the equatorial portions of the Moon which the module overflew (less than 20%). Thorium was one of three elements mapped. Concentrations in mg/g are richer in regions also heavy in KREEP deposits (Potassium, Rare Earth Elements, Potassium) as in the splashout from the impact that created Mare Imbrium. In all returned Apollo samples, lead, uranium, and thorium correlate neatly in their abundance. This tells us:

Trace lunar lead derives from thorium and uranium decay.

Where gamma ray spectrometers track thorium, we will find uranium.

Two Lunar Prospector instruments track radioactive elements. The Gamma Ray Spectrometer is mapping Thorium [#90]. The APS maps radon [#86] and Polonium [#84], but not Radium [#88]. The Rn and Po map will take longer to complete and publish.

Alan Binder, LP Principal Investigator, writes [June 6/10/’98] that “The Th map will be published in our preliminary science reports in science in a couple of months. Th and U, and

MMM Theme Issues: The Lunar Economy - Years 1-25 Dec 1986 - Nov 2011

hence KREEP, is most abundant in the Fra Mauro Formation, i.e., around the Apollo 14 landing site.”

WHAT IT WILL TAKE TO MINE & PROCESS

On Earth, thorium is found in the silicate thorite, ThSiO_4 . Common uranium ores are karnotite ($\text{K}_2\text{O}\cdot 2\text{UO}_3\cdot \text{V}_2\text{O}_5\cdot 3\text{H}_2\text{O}$), autunite ($\{\text{UO}_2\}_2\text{Ca}\{\text{PO}_4\}_4\cdot 8\text{H}_2\text{O}$), uraninite and pitchblende (both UO_2 and U_3O_8). As the first two are hydrates, we surely will not find them on the Moon. Much of Earth's supply is in sedimentary deposits, redeposited material washed away from its original location by erosion and rain.

Until we have actual lunar samples from representative locations through Lunar Prospector, we can not be sure in what mineralogical context either uranium or thorium will be found. Until we know, we risk wasting time brainstorming detailed chemical processing pathways to the refined metals. We'll need a few "ground truth" landers to analyze samples and it is not too early to start brainstorming these missions and planning to make them real.

Mars global Surveyor may identify similar radioactive deposits on Mars. These would play a key role in the early industrial development and settlement of the Fourth Planet.

FUEL OPTIONS

- **Uranium 238** (99.27 %), Uranium 235 (1 part in 137) Both long-lived alpha particle emitters with radioactive daughter product series ending with Lead. Rare U-235 fissions directly, while the relatively abundant U-238 can be used to produce Plutonium.
- **Thorium 232** + N => TH 233 - b => Proactinium 233 - b => fissionable Uranium 233.

OTHER USES FOR U & TH

Uranium – desirable colorant for glass and ceramic glazes “vivid fluorescent yellow”
– ferrous metallurgy alloy ingredient

Thorium – minor ingredient in nickel-chromium alloys

A NUCLEAR FUELS INDUSTRY ON THE MOON

Will there someday be a nuclear fuels processing industry on the Moon? If there is other industrial development of the Moon, for building materials for solar power satellites or lunar solar arrays, or helium-3 harvesting, nuclear fuels processing is likely to be part of a diversifying lunar economy.

The creation of such a nuclear fuels industry is likely to involve additional settlement locations, further globalizing the human presence on the Moon. At this time, we cannot say with confidence where such an industry would be best located. The Fra Mauro site, host to Apollo 14, may be joined by other good sites before Lunar Prospector completes its global map of U and Th. Proximity to locations chosen for other industrial activity on the Moon may have a bearing on the selection. Ease of access, shared logistics, mutual support, will all come into play.

Nuclear fuels will undoubtedly serve nuclear plants on the Moon as well as the fuel market for deep space nuclear space ships – unless helium-3 fusion becomes a superseding reality, of course. So accessibility to “coastal” sites, polar ice reserves, and to lavatube industrial complexes may be a factor. There are prior indications of Th abundance in some Farside locations as well, e.g. the double crater Van de Graaf ENE of Mare Ingenii, a site high on a short list for a Farside radio telescope array. For lunar nuclear fission power plants, both lava-tube and deep crater sites offer built-in safety. **MMM**

MMM # 123 JMarch 1999

Lunar THORIUM

Key to Opening Up Mars

By Peter Kokh

THE TIME BARRIER TO THE OPENING OF MARS

Most Mars Mission scenarios are based on the best available current technology: chemical rockets burning liquid oxygen and liquid hydrogen. It is feasible to send a scouting expedition to Mars in this manner, even though they will need to sign waivers and releases because they will be in space “too long”, absorbing more than the recommended maximum dosage of harmful cosmic rays. The added danger of solar flares can be minimized by scheduling the flights in Quiet Sun periods which occur every eleven years. “Humans to Mars” is something most of us want very much to see, so it is tempting to be brave and cavalier* about the non-trivial radiation risks.

*Dr. Zubrin shows little concerned about radiation hazards during prolonged time in space (beyond Earth’s protective Van Allen Belts), or during total time spent on Mars’ surface, poorly protected by the thin atmosphere. But it serves no point to lower mission costs by dismissing the need for shielding the outpost with soil or water reserves.

Once the glory of reaching turf formerly out of human reach wears thin, fewer and fewer people will be willing to take such risks, or to spend so large a fraction of their working lifetimes doing so (3 years, say 6%). Chemical rockets are unsuitable as workhorses to open the Martian Frontier to droves of Earth-forsaking settlers and developers. Their power limitations exact a price in the coinage of time.

- time is precious (life is too short)
- time is expensive, adding time-indexed costs
- time for overexposure to radiation
- excess time discourages tourists, settlers, developers, and traders
- excess time exaggerates difficulty of rescue, repair, replacement, resupply
- time idle promotes boredom*

Travelers can fill the months on board with university courses in fields where expertise will be useful on Mars, or back on home if/when they return. They can also keep busy assembling items needed on Mars that had to leave Earth in compact kits. But not everyone will find sufficient relief for boredom and cabin fever cooped up in a sardine can for six to nine months. This is not the 16th century. People of today will not care that their ancestors once spent comparable time crossing the Atlantic!

NUCLEAR SHIPS ALONE CAN “OPEN UP” MARS

Nuclear ships won’t be essential for an initial to land human “Kilroy Crews” on Mars, just for the political rah-rah sake of saying we did so, planting a flag, and coming home with some neat pictures and souvenir samples. But that hardly constitutes Step One toward “Opening” Mars “as a human settlement frontier”, any more than Apollo succeeded in opening up the Moon as Earth’s Eight Continent.

But unlike chemical propellants which are too quickly exhausted, nuclear fission fuels (U233, U235, and Pu239) offer the power needed for sustained high thrust, resulting in a much higher velocities. Nuclear ships can shorten transit times, extend windows, and telescope round trips, and just as importantly, cut all time-indexed costs. Nukes could cut transit time to Mars down to eighty days or so, per Stan Borowski and make Mars a nearby, viable human frontier.

AN ENVIRO-POLITICAL MONKEY WRENCH

Would trans-atmospheric shipment of fissionable U-233 evoke as much enviro-political concern as that of the Plutonium-239 that fuels NASA’s deep space missions Galileo, Cassini (and hopefully, the Pluto-Kuiper Express? The assumption behind this article is that, given the guaranteed irrationality of rabbleocratic political process, no distinction may be made. If not, then the dream of opening up Mars, asteroidal resources, and the Outer Solar System could die

MMM Theme Issues: The Lunar Economy - Years 1-25 Dec 1986 - Nov 2011

- unless! Unless we can ship unfueled nuclear engines and reactors through the atmosphere, and refine the fuel they need on the Moon.

Unless the supply of nuclear fuel throughout the Solar System is assured, there is little point in developing the engines that would use it, nor the spacecraft that would use such engines. Research on nuclear propulsion continues, primarily at NASA-Lewis, on the presumption that fuel is a non-issue.

THE MOON CAN RESCUE THE MARTIAN FRONTIER

Lunar Prospector has been gathering data for a global geo-chemical map of the Moon and thorium is one of the elements on which it has been zeroing in. There seems to be economically minable amounts in some accessible areas.

{**thohr'**-ee-uhm} This element is a soft, very ductile metal, silvery in color. It is in group IIIB of the periodic table, a member of the actinide series. It was found radioactive in 1898 by Marie Curie. It had been discovered in 1829 by Swedish chemist J. J. Berzelius, who named it for the Norse god Thor.

Thorium reserves contain more available energy than all uranium and fossil fuel reserves combined

See also MMM #116 JUL '98, pp. 7-8, "URANIUM & THORIUM on the Moon", P. Kokh

Thorium-232 can be used in a breeder reactor to produce a fissionable uranium-233 through neutron absorption, in the same manner Plutonium-239 is bred from Uranium-238. The reaction sequence is shown in the page 1 graphic. (Beta decay is the "transformation" of a neutron into a proton, with the emission of an electron for charge conservation, and an anti-neutrino for energy and momentum conservation.)

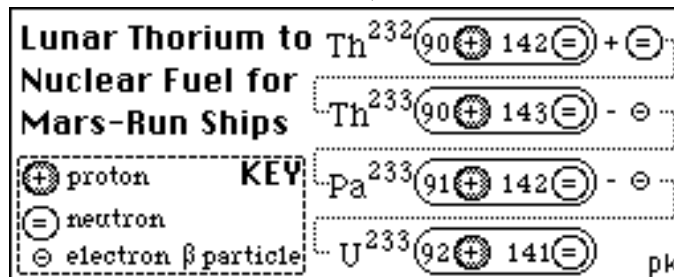

U-233's physical and chemical properties make it much less difficult and dangerous to handle than extremely toxic Plutonium. Further, the thorium=> uranium cycle is vastly less dirty than Plutonium production. An energy amplifier reactor fueled by thorium has significant advantages:

- the reactor is essentially sub-critical
- much less transuranic actinide waste is generated
- much less radiotoxicity especially if the bred 233U and additional U isotopes are recycled
- thorium can be rendered proliferation resistant through mixing with the isotopic denaturant U-238

On the Moon there is neither air nor ground water to pollute or infiltrate. Storage of wastes in a lavatube would be cheap, easy, and absolutely safe.

A lunar thorium-based nuclear fuel production operation could be highly automated. A manned station will be needed to tele-operate mining equipment, make repairs, and ship the packaged product.

Moon-based shuttles, and later, a mass driver (once the volume of demand warrants) would ship the U-233 fuel to (a) Fueling Depot(s) in one (or both) of the stable Lagrange points (L4 and/or L5, 60° {or 5 days} ahead of/behind the Moon in its orbit around Earth), conveniently outside the lunar gravity well, yet easy to reach from Earth and Moon alike.

MMM Theme Issues: The Lunar Economy - Years 1-25 Dec 1986 - Nov 2011

Assuming five-day margins, nuclear rockets could offer affordable windows to Mars from 3 weeks a month from these twin "Marsgates" – for at least the major portion of the 25 month long synodic period between optimum Earth–Mars lineups. Not only will the length of trips to and from Mars be cut appreciably, but the constrictive timing of the narrow and infrequent windows would cease to choke traffic.

On its first year mission, Lunar Prospector identified the Fra Mauro region, south of Mare Imbrium and the great crater Copernicus, as notably rich in Thorium. This is the area visited in January, 1971 by Apollo 14 (the Antares with Alan Shepard, Edgar Mitchell). It is just south of the lunar equator, making a mass driver shipping operation practical.

Lunar Prospector is now in an extended mission in a low surface-skimming orbit, affording closer scans at higher resolution. By mid year (1999) we may know if its gamma-ray spectrometer has better localized the thorium rich deposits in the Imbrium splashout area. We may soon have a short list of ideal sites for our nuclear fuel production operation.

A REASON FOR MARS LOVERS TO LOVE THE MOON

It would seem that those driven by the vision, not just of a human scouting science-picnic outing to Mars, but of going beyond that to open the Red Planet as a Frontier for settlement, and as an eventual second human home world, would put thorium mining and U-233 production on the Moon near the top of their "must-do-first" list, right after development of nuclear rocket engines themselves. Yet outspoken proponents of "Mars First" seem pre-occupied with doping the discussion with a list of impatient bogus reasons to "avoid" a lunar "detour".

Lunar Thorium may be the number one utility of the Moon to the Mars Frontier constituency. But there are other benefits that shouldn't be dismissed:

- Handier dry run equipment & procedure test-outs
- Cryogenic rocket refueling
- Manufacturing heavy components needed on Mars
- Source of willing, tried and seasoned pioneers

Just as the "Earth Problems First" crowd overlooks the possibility that the solution to some of Earth's most intractable energy and environmental problems may just lie in space, so do some "Mars First" people overlook the possibility that any of the sine qua non prerequisites for "opening" Mars as a Frontier may involve a lunar operation. Emotions that have become almost "partisan" are getting in the way.

We are not saying that Lunar thorium will be needed to fuel nuclear power plants on the Martian surface. Mars Global Surveyor may identify similar deposits on Mars. Pioneers on Mars will duplicate the Lunar facility. Having a workable debugged operation on the Moon will make design and construction of a similar industry on Mars itself that much easier.

REASONS FOR MOON LOVERS TO LOVE THORIUM

A thorium-based lunar nuclear fuel industry will have benefits for lunar industrial diversification. Among many uses for thorium and thorium compounds these three promise to be especially welcome on the early Lunar Frontier.

- alloying element for magnesium, imparting high strength and creep resistance at high temperatures
- thorium oxide is used for high-temperature laboratory crucibles
- glasses containing thorium oxide have a high refractive index / low dispersion – used for high quality camera lenses and scientific instruments

MARS RUN LUNAR THORIUM FUEL ECONOMICS

Nuclear power plant architects and engineers familiar with thorium, and chemical engineers who can figure out how to most economically extract it from lunar soils, will need to work together to come up with a set of overall designs and operation plans for such an industry before we can begin to estimate the price. It won't be high in relation to the payoffs.

MMM Theme Issues: The Lunar Economy - Years 1-25 Dec 1986 - Nov 2011

Those who would open up the Mars Frontier would have to pay much of the bill for creating such a thorium-based nuclear fuels industry on the Moon. Lunar developers will want nuclear power plants. So they will chip in their share. So will those who need nuclear rockets to access asteroidal resources.

Those determined to open Mars, may find no politically realistic alternative if they want to make Mars-run nuclear ships a reality. Choose not to pay the price and it may cost the dream. **MMM**

Be a doer, not a watcher.

The watcher is likely to be disappointed.

The doer has the comfort of knowing that he has tried, and

Perhaps laid foundations, for others who follow, and may reach the goal.

“Do not go where the path may lead.

Go instead where there is no path,
and leave a trail.”

– Mongolian proverb

MMM # 126 June 1999

“Potentiation”

A Strategy for Getting through the Nightspan on the Moon’s Own Terms

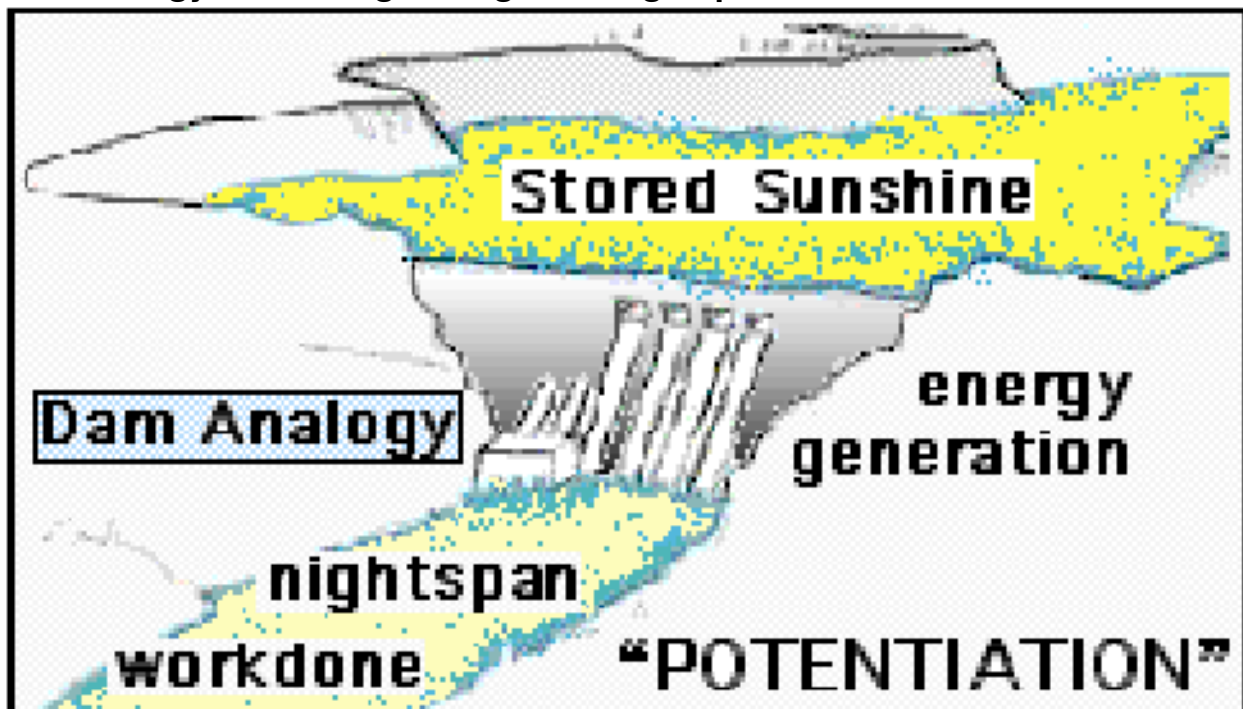

By Peter Kokh [Presented at ISDC 1999, Houston]

Taking Back the Nightspan

MMM Theme Issues: The Lunar Economy - Years 1-25 Dec 1986 - Nov 2011

On Earth, in many urban areas, there is one special night given over to the assertion of everyone's right to be out and about, safely, at night. "Take back the Night" is aimed at programs that neutralize or reduce nighttime crime and violence that in some areas has frightened people into remaining imprisoned in their homes between sundown and sunup the morning after.

On the Moon, the nightspan is 14.75 days long, 30 times as long as an average terrestrial night. Sunshine is the principal readily tappable local source of energy on the Moon. Its unavailability during nightspan makes the Moon a forbidding place to many people.

If you are one of these, you may need to take a serious look at your pioneer spirit quotient [PSQ]. In every one of the frontiers of the past, pioneers found themselves challenged by the unavailability of various things they had taken for granted in their native homelands. Those who survived, did so by turning to their inner resourcefulness; they "found" ways, not just to make do, but to thrive under. This inventiveness, this eagerness to take on challenges, seems disturbingly lacking in many space-interested people today, the very segment of the population one would expect to be most ready to imagineer their way around every obstacle.

Some of these "discouragees" would rely on nuclear power alone. But if there is a nuclear power plant anywhere on Earth without either planned or unplanned downtime or both, we haven't heard of it. Nuclear is fine – but it can't be relied upon 100% and prudent settlers will have backup power generation capacity. To the extent it will serve genuine settlement, not just a token "Kilroy was here" outpost, nuclear has to be "Lunar Nuclear". But more on that later.

Other discouragees just give up and would restrict themselves to a couple of tiny sites at both lunar poles where it is "purported" that "sunlight", always more or less tangential to the surface, is available month around. In fact, the "Peak of Eternal Light" at the south lunar pole enjoys sunlight only 86% of the time with several dark periods. All such spots are inevitably mountain peaks or crater rims, not exactly prime turf upon which to land or erect a base for routine operations.

Some are so intimidated by the lunar nightspan, that they would bypass the Moon altogether in Human expansion into the Solar System.

What we have to say is meant instead for those of you who welcome the challenge of the nightspan. Fully 99.99% of the Moon's surface outside the permashade areas in polar craters experiences alternating two week long dayspans and equally long nightspans. If we are going to "do the Moon", this is the Moon we need to do.

We will not earn the right to say we have a permanent human presence on the Moon until we have learned how to deal with the Moon on its own terms. We have to take back the night, the lunar nightspan from the dread bogeyman of the energy desert that tests us. Lunan pioneers with the right stuff will learn not to fear the night, but to love it and cherish it as an equal movement in life's rhythms.

Potential Energy Reservoirs

Potential energy is the reserve energy an object has by virtue of its position in an energy gradient. There are several kinds of "energy hills". All kinds of potential energy reservoirs available on Earth are also available on the Moon. It is up to us to build these various reservoirs, and fill them.

This deliberate effort we dub "potentiation". Potentiation will not only make energy available for the nightspan, it will take energy to put in place. And the unlimited solar energy available everywhere on the Moon outside permanently shaded polar craters is tappable to do the job. The dayspan holds all the keys to the nightspan. But we have to do the right things during dayspan to make our plan work. We have to not only use available solar energy, we must produce a surplus, and store it "uphill". The endless broad and deep river of sunshine can be dammed up. The dams can take various forms of "uphill" holding reservoirs: gravitational, thermal, chemical, angular momentum, and radioactive.

Gravity Slopes & Hydroelectric Power

MMM Theme Issues: The Lunar Economy - Years 1-25 Dec 1986 - Nov 2011

Gravity hills, slopes, gradients, wells: something is placed at the top of a slope, poised to create energy by being allowed to fall. On Earth, we dam up rivers at convenient constricting points. This creates a "head". Water is allowed to spill over the dam in a controlled fashion, gathering momentum from its plunge, and using this momentum to spin turbines that run electric power generators.

No rivers on the Moon? No problem! Wherever we place our outposts and settlements, we will need appreciable amounts of water: as an essential component of whatever minibiospheres we establish to reencradle ourselves; for food production; for drinking, washing, and hygiene; for use as recyclable reagents and handling media in industry. We will need a substantial water surplus, in part consisting of water being recycled and purified.

During dayspan, solar energy can be used to pump the water surplus uphill: nearby crater rims, rille shoulders, or the surface above lavatubes. At night this water is returned to the loop through tubes plunging to turbine generators downslope.

Of course, the amount of water available for this form of nightspan energy generation depends on the generosity of the settlement's water endowment. Now that Lunar Prospector has confirmed the discovery of substantial water ice reserves at both lunar poles, this idea is not far-fetched.

What about the low lunar gravity? Won't that work against the idea? Well, Niagara Falls, which produces a lot of power, has a head of about 150 feet. To match that head, we'd have to have a reservoir 6 times as high above the generator turbines, or 900 feet up. Some Crater rims are 10,000 feet or more above the crater floors. Many mare coastal sites are near high rampart mountains. These sites are advantaged by access to both major suites of regolith materials (highland soils rich in aluminum, calcium, and magnesium, and mare soils enriched in iron and titanium). Even mid-mare sites that involve the use of lavatubes will come with ready "heads" of several hundred meters between the exposed surface and the floor of the tube underneath. Nor is a Niagara-equivalent head needed. There are many working low-head hydroelectric sites around the country in the 20 ft. range. Where there are no natural "heads" for reservoir placement, we can simply build water towers hundreds of feet high, using dayspan solar to pump them full.

Now let's play with this idea. Dayspan sunshine can also be used to purify and treat the water in the reservoir – if the reservoir is covered with ultraviolet transparent quartz (pure silicon dioxide glass). Going a step further, dayspan sunshine can be used to electrolyze this stored treated water into oxygen and hydrogen. After nightfall, the hydrogen and oxygen can be recombined in a bank of fuel cells, producing both energy on the spot, plus the water to fall downhill to the generator turbines, producing yet more energy. All these processes would have to be paced to extend this potential energy resource through the long nightspan.

Lunar Hydroelectric as sketched above, is the brainchild of Myles A. Mullikin, Lunar Reclamation Society cofounder. It was one of several of his major contributions to our "Prinzton" runner up entry in NSS's Space Habitat Design Competition during the winter of '88-'89.

Hydroelectric power on the Moon is the last thing that occurs to most people mulling the problem. But it turns out to be very realistic for any kind of outpost or settlement. No one pretends the amount of energy stored during dayspan and produced during nightspan by a hydroelectric scheme will meet all the settlement's power needs. But it is one workable component of a mix pioneers will have up their sleeves. Planners should consider incorporating such interactive water storage into the settlement utility system.

Chemical Energy Stores

If we can use available dayspan solar power to reduce chemical substances into fuels that we can oxidize at night, this would be another way of storing surplus dayspan sunshine. And an especially convenient way at that, for such fuels can run not only static generators, but mobile engines in vehicles.

The polar water ice reserves are, by common expectation, derived from comet volatiles, reaching the Moon by impact, and migrating during the safety of nightspan (in the lee of the

MMM Theme Issues: The Lunar Economy - Years 1-25 Dec 1986 - Nov 2011

dispersing solar wind) to the permanent safety of permanently shaded polar cold traps. Now comets include large amounts of volatiles other than water. Carbon oxide and nitrogen oxide ices are a major component. We can hope that some of these volatiles will have reached the safety of the polar permashade fields and be found intermixed in the water-ice. The Lunar Prospector team has characterized the polar water ice as relatively pure. But this is with respect to mixed in regolith, not necessarily with respect to other volatiles.

Now the pioneers will need lots of water. But 89% of water by weight is oxygen. As Oxygen makes up 46% of lunar soils by weight, what the pioneers will really need is the polar=hydrogen. Shipping water with megatons of included oxygen to settlement sites will be like shipping coals to Newcastle, or ice to Alaska. On the other hand, hydrogen is relatively hard to handle and ship as either liquid or gas.

If the polar reserves include carbon monoxide or carbon dioxide ices, available solar power could be used to refine these ices, reducing them chemically to methane, CH₄. Shipped or piped as either liquid or gas, both the hydrogen and carbon will be most welcome. And combining them with local oxygen (produced from the soil by solar power on site) in fuel cells during the nightspan to produce water, carbon dioxide for the biosphere, and water. The portion of methane arriving during dayspan could accumulate in storage tanks until nightfall. In this way, dayspan sunshine both at the poles and on site is used to produce nightspan=usable fuel and power.

Additionally, methane can be produced in the settlement from composted waste biomass, and used as a fuel for motor engines or generators, producing power, water vapor, and carbon dioxide, a necessary component of the settlement atmosphere. "Biogenic" methane will be an important ingredient in making the settlement biosphere work – why not also use it to help the settlement through the nightspan?

Electrolysis of on hand water reserves using surplus dayspan sunshine is another way to accumulate and store fuel for nightspan use, namely, oxygen and hydrogen to burn in fuel cells, as we've already mentioned. In short, we need to take the dayspan opportunities out there to charge various types of chemical batteries for nightspan use. This is the simple pioneer virtue of "energy husbandry."

Angular Momentum "slopes"

Large flywheels made of lunar materials, metal alloys or composites, could be placed in small-sized crater bowls for safety. The crater rim slopes would catch any shrapnel if the flywheel's angular momentum exceeded its cohesive strength and disintegrated. Flywheels could also be placed in lavatube voids. During the dayspan, solar electric power could be used to rev up the flywheel. An expandable modular bank of smaller units would combine safety and the ability to store whatever amount of power might be needed.

Thermal slopes & Magma Pools

The Moon is dead geologically speaking. So "geothermal" or seleno-thermal power is out of the question, right? Not for those with imagination! If there is an early cast basalt industry to provide paving blocks and other low performance items of use to the expanding base, possibly as a sideline to oxygen production through heating the moon rock, the excess residual pool of molten regolith produced during the dayspan can be stored in subsurface voids as pools of magma, shielded from the heat-sucking night sky. These holding reservoirs could be lined with refractory materials made on the Moon. The poor thermal conductivity of the regolith overburden will work to conserve the magma pool's heat. How much energy do you need to get through the nightspan? Just melt and store that much regolith as molten magma. This is the vision of Lunar Reclamation Society member-at-large David A. Dunlop.

As highland regolith generally has a higher melting point than mare regolith, highland regolith can be melted and cast to form a refractory container for mare magma. As we progress further in extracting purified elements, we can improve on this by casting refractory elements out of aluminum oxide.

MMM Theme Issues: The Lunar Economy - Years 1-25 Dec 1986 - Nov 2011

This regolith melting operation need not be undertaken solely for the purpose of providing a high heat reservoir to tap for nightspan energy. Fused and cast regolith products, specifically cast mare basalt, could provide a whole suite of useful products in the early settlement era, products where high performance is not a requirement: floor and paving tiles and slabs, tableware (dishes), table tops, other furniture items, pots large and small to be used as planter beds, other artifacts, etc.

Cast basalt as a building material and manufacturing stuff may seem exotic. But in fact, there has been a cast basalt industry in central Europe for ages. We need to become familiar with this precedent and take it further, so that when we return to the Moon, we can hit the ground running. Oregon and

Hawaii would be good places to practice.

Nader Khalili of the Geltaften Foundation has developed a detailed proposal for casting shelter modules. Casting into a spinning mold would be one simple method of forming conical and hemispheric shapes. Adding crude glass fibers made from highland regolith to the magma mix would provide considerable strength to the finished product.

Magma heat can be used to melt and cast materials with lower melting points, to bend and temper alloys, to glaze ceramics, to crack complex compounds into simpler chemical components, and so on. If this manufacturing activity continued right up to sunset, a leftover magma pool would remain, ready to be used to produce steam to run generators.

There should also be a way to tap the residual heat of recent castings still in the kiln. As magma and castings would slowly cool, it'd seem reasonable to use up the magma heat for electrical generation first, phasing in hydroelectric and fuel cells as the magma pool cooled below the point of usefulness.

Further, magma-generated steam can do more than run generators. Steam can transport heat for baking and curing and heating. Steam can run air compressors and ventilators. Steam can pump water. Steam was once king. Now it is largely forgotten. Lunar pioneers would do well to take a second look.

Mark Reiff suggests another form of lunar heat pump. If vibro-acoustic testing locates a relatively small underground void (cavern) near the surface (less than 100 feet), this can be accessed by drilling. The natural reservoir can then be filled with a thermally conductive material (e.g. smelting regolith into molten aluminum). The thermal properties of the available material should drive the purity requirements. The material would be allowed to reach an equilibrium (cool).

Next you would set up a thermal dynamic generator (Sterling cycle would work good) with your heat source on one end and the newly created heat sink connected to the other. You could shade the generator and the top of the heat sink to even provide power by dayspan too. [Smelting aluminum, however, is not likely to be an early outpost technology – Ed.]

Modular Home Solar

At ISDC '98, we spoke of a modular approach to biospherics, designing every lunar habitat and function space to pretreat human wastes generated therein. If we consider that a lunar settlement is not something that will be built all at once, but which may grow and grow, a similar modular approach to providing needed electrical power generation seems appropriate as well.

To some extent it may be possible to do this habitat by habitat for surface settlement structures where dayspan sunshine is available just above the shielding overburden. For face settlement complexes, individual habitats could have solar panels above, designed to catch the sun's rays from the changing angle through the dayspan. This could be either a first or complimentary source of power, reducing the amount that had to be provided by the common settlement grid, and taking the edge off the settlement's growing pains. Such an approach also distributes vulnerability.

We need to seek for practical ways individual habitats could store, and later tap, excess or surplus solar power for nightspan use. On Earth, The Mother Earth News has long taken the

MMM Theme Issues: The Lunar Economy - Years 1-25 Dec 1986 - Nov 2011

lead in helping individual homesteaders to become increasingly self-sufficient and self-reliant. The TMEN spirit provides an invaluable inspiration for future lunar pioneers. Most TMEN-illustrated “appropriate technologies” will not be directly translatable to lunar situations. But the spirit needs to be copied. Hopefully, a Mother Moon News will lead the way in this regard. Indeed, in our own personal dreams, we live long enough to graduate from being editor of Moon Miners’ Manifesto to becoming editor of The Mother Moon News.

“Working Smart” – Operations Engineering

We need to provide electrical power for these nightspan activities: production, work in general, daily living, and recreation. No matter what mix of power generation sources we use for this purpose, and whether or not a nuclear power plant is available as a major part of this mix, there is no escaping the fact that there will ALWAYS be MORE power available during dayspan than nightspan. Why? Because dayspan has available unlimited solar power in addition.

It is unbelievably naive then, to try to plan a lunar economy in which the very same mix of tasks is performed dayspan and nightspan alike without any difference. Here on Earth we are spoiled. We want to do what we want to do when we feel like doing it. Hopefully, the lunar pioneers for whom we are paving the way will be a little smarter, and a lot wiser. Lunans will need to “work smart”, going through the task load at a pace that goes with the grain of the host environment.

This means a simple rhythm that divides the task load, industry by industry, occupation by occupation – wherever practical – into one set of more energy-intensive tasks to be accomplished during dayspan, and a second complementary set of energy-light, perhaps more manpower-intensive tasks to be gone through during nightspan.

Lunans will do more production work during dayspan, more maintenance, inventory, packaging, and shipping work during nightspan – again, to the extent feasible. Even here on Earth, some electric utility companies use a two-tiered rate structure to encourage their customers to voluntarily postpone some high-load activities to non-peak usage hours.

On the Moon we are talking about the same thing, on a monthly rather than daily basis, and on a much more extensive scale. It is reasonable that on the Moon electric power to industrial consumers will be priced much higher during nightspan to encourage this type of cooperation. The whole lunar economy will operate as some giant alternator, or as a set of lungs that inhale and exhale.

For manufacturers and others, this means adopting a whole new Philosophy of Operations. It means hiring Operations Managers who are enthused supporters of the new modus operandi, rather than those who resist it kicking and screaming.

For workers and others, this task-sorted, polarized operational scheduling will provide a fortnightly change of pace. On the Moon, where there is no changing weather, not even any changing seasons to provide some welcome freshness to life, this bimonthly change of work rhythm will be a psychological bonanza. Those who would insist on running their operations as if dayspan and nightspan made no difference, will find their employees to have lower morale and a greater incidence of psychological and personal problems in comparison.

If some industries have an imbalance, either a preponderance of energy intensive or energy light tasks, they might trade some workers. An energy-intensive casting operation may transfer many of its employees to a sister operation in some industry that has an excess of manpower-intensive, energy light tasks. Such bimonthly change of pace switches might be a much-loved perk for the people involved. Variety is the spice of life. Predictable changes of pace can be salutary and welcome.

It is likely that the load of production and export oriented tasks will still be lower in terms of man-hour needs during nightspan than dayspan. So the two nightspan work weeks could be shorter, either in work hours per day, or in work days per week, or with more generous flextime rules.

Surplus free time could be used for hobbies and/or building up individual cottage industries. Thus the lunar nightspan could be the principal generator of new private

MMM Theme Issues: The Lunar Economy - Years 1-25 Dec 1986 - Nov 2011

enterprises, a wellspring of lunar industrial and economic diversification and continued growth. The domestic economy would be the first beneficiary, but it is inconceivable that new export lines would not emerge from such enterprise.

If this nightspan power “deficit” were ever to be effectively eliminated, the biggest source of rhythm and change of pace would be gone with it. Productivity gains would be temporary as morale slowly plummeted from routine, boredom, ennui.

It’s all about learning to live on the Moon, on the Moon’s own terms. On Luna, do as the Lunans do! On Earth we have many examples in Nature of plants and animals who have seasonal changing rhythms: squirrels, birds, bears, the list goes on and on. Their daily rhythms adjust to sometimes drastic changes in the environment.

Another analogy is offered in the extreme in bimorphic biological economies, demonstrated by the primitive Hydra, a minute aquatic animal that exists in two quite different alternating generations, the polyp, and the medusa. Similarly, on the Moon, the dayspan economic activity will lead into the nightspan economy which will prepare for the next dayspan and so on indefinitely – two bimorphic generations of one and the same economy.

Lunar Appropriate Nuclear Power

(1) If nuclear power is to be a major player on the Moon, we have to look beyond the dawn period in which ready-to-run nuclear plants are imported from Earth. That’s fine for a limited dead-end Antarctic style small outpost which is not expected to grow in its energy requirements. We are not among those inspired by, or envious of the Antarctic achievements. Instead we foresee a continually growing industrial and civilian settlement network on the Moon. And so we look beyond such seemingly lead-nowhere options to a uniquely “lunar-appropriate nuclear power industry”. Such an industry would incorporate these features.

- The lunar nuclear power plant should burn nuclear fuels produced on the Moon as
- (a) Export of nuclear fuel through Earth’s atmosphere may be embargoed by the political successes of those environmental extremists who even now oppose RTG-powered spacecraft to the outer Solar System. And
 - (b) Even if this scenario should be successfully avoided, reliance on politically fickle regimes on Earth for sourcing absolutely critical needs, such as nuclear fuels, would mean perpetuating blackmail-inviting dependence upon Earth on the part of settlers.

Lunar Prospector has mapped major Thorium reserves on the Moon. Thorium can be transmuted in lunar fast breeder reactors into fissionable Uranium 233. [see MMM # 123 March ‘99, pp. 6-7 “Lunar Thorium: Key to Opening up on the Moon”] Thorium can thus power industrial expansion on the Moon, as well as fuel nuclear ships on the Mars run, without which it is not reasonable to expect the Mars Frontier will ever be opened to settlement.

(2) Nuclear plant engineers and architects need to follow the “MUS/cle” paradigm in which the more Massive, Unitary, Simple components are manufactured on the Moon, and only the more sophisticated complex, lightweight, and electronic “works” subassemblies are manufactured on Earth.

This division of manufacturing labor will work to keep total imported mass low and maximize the lunar contribution for best overall affordability – all while building lunar industrial muscle. All Moon-based industries need to follow this paradigm if the lunar economy is to run in the black.

3) A standard small “gangable” nuclear plant module must be the goal of this joint MUS/cle design and development process. The modules need to be relatively inexpensive, and manufacturable on demand in quick order, “cle” part on Earth, “MUS” part on the Moon. They need to be functionally gangable into multiple module plants to fit the growing energy demands of quickly expanding settlements as well as small static outposts.

The Moon does have an abundant supply of Helium-3, the ideal fusion fuel. But fusion power has yet to be demonstrated as an engineerable reality.

MMM Theme Issues: The Lunar Economy - Years 1-25 Dec 1986 - Nov 2011

Other nightspan power solutions frequently proposed are well down the road, something for later generation advanced settlements to consider. These include solar power satellites (the only viable locations not requiring station keeping fuel are L4 and L5 ten times as far from the lunar surface as GEO is from Earth), lunar solar array networks (one over the nearest pole makes the most sense as it would be in sunlight whenever the base is in darkness), and lunar superconducting power storage rings (the prognosis is not good for finding a material producible on the Moon that is superconducting at the temperature of liquid oxygen, the lunar sourceable coolant of choice).

A Tale of Two Cities

Those for whom everything old is worthless, and only the new deserves consideration, and those without patience for the inconvenience of having to rethink operations to reschedule them as paired sets of energy-intensive and energy-light tasks that can be performed sequentially, will champion an all nuclear Moon. Let them enjoy their horse blinders.

If we could imagine two identical starter settlements, both in equally favorable sites for local resource-based industrial expansion, but one all nuclear, the other with a healthy reliance on dayspan solar for potentiating nightspan power needs in addition to a nuclear base load, it should be clear that

if we revisit them twenty years down the road, it will be no contest which settlement will have grown the most both in population and economic diversity and prosperity.

We need to take a holistic approach to solving energy problems on the Moon. The Moon is a place where we can do precious little as we have been used to doing things on Earth. The Moon is a place where we will be challenged to the utmost in many ways. To be equal to the challenge, we have to

examine all the options and hedge all our bets. And, we have to embrace life on the Moon on the Moon's own terms.

As we have taken pains to point out, most of these proposed alternative nightspan energy sources mesh well with the industrial and/or biosphere maintenance needs and goals of the settlement. Even if we have adequate power from a nuke – adequate for the time being anyway – it would be plain stupid not to develop the water reserve-fuel cell cycle, the magma pool-cast basalt cycle, and the methane engine fuel cycles. A settlement that opted not to do so, would court failure.

Conclusion – The Habit of “Energy Husbandry”

In short, if we are going to “do the Moon” we must engage the Moon on its own terms: we have to bite the bullet of dealing with the lunar nightspan head on. Unfortunately, biting the bullet is not a virtue of the predominant space culture. On another issue, writers and visionaries may talk all they want about artificial gravity for space stations and for space vehicles on long journeys. But in industry and agency alike, this is an “unmentionable” by “unspoken” agreement. NASA is in the zero-G rut, comfortable to the point of addiction, deaf and blind to reasons to go beyond this cozy nest.

That is one vector of space that the powers that be have no wish to explore. The lunar nightspan is another such vector. We avoided it totally in the Apollo Program – all our landing excursions took place entirely in the local lunar midmorning timeframe. As NASA does not allow itself to look beyond a limited crew lunar outpost, the idea of a growing flexible power demand can be conveniently pushed back into the nearest closet.

For those of us who have greater dreams, it is absolutely vital that we hitch them to a less tired old horse. We are given, on the Moon, a highly polarized environment. We need to learn how to dam up this overabundant dayspan sunshine so we can tap this reservoir for productive activities all nightspan long. Only then can we boast that “we have arrived” on the

MMM Theme Issues: The Lunar Economy - Years 1-25 Dec 1986 - Nov 2011

Moon, that our presence is “permanent”, that we have truly become the adoptive children of this raw unforgiving world, that we have become “Lunans”.

Lunans will “husband energy”, and learn to mine “energy tailings”. In doing so religiously, they will empower themselves not just to “get through” the nightspan, but to producing a “second harvest” from the dayspan sunshine in the process. In time, to Lunans it will have become quite clear that the long nightspan is an asset, not at all the dread liability that today dispirits many. Those who need Earthlike conditions and settings will have to wait a long time before the space economy generates enough wealth to produce them artificially. Meanwhile, pioneers with the right stuff will be ready. <MMM>

Relevant Readings from MMM back issues

MMM # 7, JUL '87, “POWERCO”

MMM # 31, DEC '89, pp. 3-5, “Ventures of the Rille People” (Prinzton design study), V. *
Multiple Energy Sources.

MMM # 43, MAR '91, pp. 4-5. “NIGHTSPAN”

MMM #90 p. # NOV '95 pp. 7-8 “OVERNIGHTING: Consummating the Marriage of Moon & Base”

Always listen to experts.

They'll tell you what can't be done and why.

Then go do it.

– Robert A. Heinlein

MMM # 128 September 1999

Justification for Early Operation of a Lunar Mining Facility

©1990 John K. Strickland

In order to justify building a lunar base, immediate payback goals should be included in the base plan, as well as longer term payback from lunar and astronomical science.

These short term paybacks primarily involve using the moon of a source of raw materials that are already 95% “in space” in terms of launch energy requirements. They include:

1. Early production of liquid Oxygen for (1) direct and immediate refueling of the reusable lunar ferry vehicles using lunar oxygen and terrestrial Hydrogen; (2) propulsion use in low and high Earth orbit and for transit between Earth and the Moon; (3) oxygen supplies for the lunar base and in-space air supplies; (4) react with Hydrogen (from Earth) for lunar and in-space water supplies.

2. Early production of structural materials (Silica and metals) for (1) truss (lightweight beam assemblies) for the Solar Power Satellite system; (2) lunar base structures.

3. Silicon for SPS solar array.

The main point is that functioning “prototype” equipment sized to produce enough LOX to support base construction flights should already be in an advanced stage of perfection by the time of the first base construction landings. If there are any questions about certain phases of a process, small test packages could even be carried on pre-base landings to prove out the technology, or it could be tested in a 1/6 g centrifuge adjacent to the space station. The advanced prototype would be designed to operate semiautonomously, requiring only the attachment of solar foil and addition of lunar regolith. The main advantage over the robot Mars fuel factories proposed by Robert Zubrin is that repairs could be made if necessary, but the design could be similar.

MMM Theme Issues: The Lunar Economy - Years 1-25 Dec 1986 - Nov 2011

The units would be landed early in the base construction sequence. We could then expect production of LOX to begin fairly soon after base construction starts, and the LOX supply would assist in the completion of the base, as well as in bringing in additional cargos for science and additional habitat modules. This would greatly reduce the costs of bringing propellants from Earth, since the LOX is almost 90 percent of the propellant weight if Hydrogen is used as the fuel.

Later in the base construction the segments of mass drivers and or smelters would be landed. These would depend on the decisions made earlier on the type of lunar derived structural materials to be used for the Solar Power Satellites and/or for lunar structures. The bulk of these would probably be glass/glass composites such as those currently being developed, and the metals aluminum, iron, magnesium, titanium, and perhaps calcium. <JS>

MMM # 129 October 199

\$elficiency Tests & Goals

SELF-SUFFICIENCY TESTS & GOALS

By Peter Kokh

We've already hinted at some not directly economic things that might be considered as bench marks of pioneer and frontier achievement "meriting increased home rule":

- Increases in population, e.g.: 100, 300, 1000, 5000, 25000, 100,000, 250,000, one million
- Educational capacity: K12, technical college, full university (list of critical departments), degree of involvement of the university in creation of new enterprise and in increased Industrial diversification, involvement in arts and craft media development, fractional gravity-sensitive performing arts, etc.
- Medical capacity: to treat most trauma, common diseases, pediatrics, maternity ward, etc. advanced capacity: neurosurgery, oncology, etc. (advances counted in reduction of the percentage of cases that must either be sent to hospitals on Earth or left to die as comfortably as possible.) medical advances in the area of lunar-peculiar medical problems
- Progression from an all worker society towards the normal mix of working adults, children, and seniors given productive roles suited to their slowly diminishing capacities
- Progression from a one settlement operation to an actively inter-trading association of frontier communities with consequent growth both in domestic and export economies
- Increases in the ratio of native Earthborn individuals electing to stay in comparison to those still rotating back to Earth
- Increases in the proportion of native born Lunans
- Ongoing assessment of the comparative health of native born
- Lunans over several generations
- Diversity of the gene pool (another article)

Balance of Trade QUESTIONS

BALANCE OF TRADE QUESTIONS

By Peter Kokh

The following items are vital because they affect the economic viability equation:

- Stockpiles of critical imported reserves (volatiles not yet produced in enough quantity locally, emergency food rations, parts for essential equipment, backup power units, etc. etc.) e.g.: 6 months reserves, 12 months, two years
- Increases in percentage of architectural and building products and units manufactured on the Moon versus imported from Earth (increases in the degree by which population expansion can be wholly supported locally)
- Increases in the percentage of food and other agricultural products grown locally both in terms of total tonnage and in diversity (progress towards a locally supported diversified foods menu)
- Increases in percentage of total mass of products manufactured on the Moon in comparison to the total mass of products that must be imported from Earth (reductions in import dependency)
- Increases in the number, relative worth, and deferred import value of new lunar sourced “substitution products” to replace items that had been imported from Earth because equivalent products could not be manufactured from commonly available lunar materials
- Increasing levels of industrial and commercial diversification (economic insurance against the vulnerabilities of one export product economies)
- Increases in the percentage of exports sold to other space markets (including LEO and GEO) in relation to those sold directly to Earth.
- Increases in the diversification of products sold to other space markets
- Increases in the percentage of imports from other space markets in comparison to those coming from Earth (these last three considerations will indicate the degree of integration of the Lunar economy into an emerging wider solar system economy extra terrestrial sector.)
- Growth of a local machine tool industry
- Growth of a local electronics industry
- Growing percentage of surface vehicles, for out-vac and in-habitat use with majority (by mass) content locally manufactured
- Growth of spacecraft servicing and reoutfitting capacity

MMM # 132 February 2000

“Spinning-up” Frontier Enterprise Profitable for both Earth & Space

By Peter Kokh

The outlook for Space Enterprise would seem to be grim in the wake of the Motorola Iridium bankruptcy. We beg to differ. Yes, investors will be wary of big space enterprise proposals after this major collapse. But how, in truth, would the success of Motorola's effort or of any similar effort help open the space frontier? It would have helped build the market for small payload launchers. Our point is that small satellites and small payload launchers, while they may make money for individuals who may also happen to be interested in opening space

MMM Theme Issues: The Lunar Economy - Years 1-25 Dec 1986 - Nov 2011

as a human frontier, do not in any direct way remove any of the considerable hurdles confronting those who would open space to human beings on any truly non-vicarious, non-virtual level. Small payload CATS, certainly good in itself, is probably not much more than an energy-sucking detour.

We need cheap access to the threshold of space, LEO, for large payloads and for people. AND we need cheap, fast transit "in" space itself. AND, once we can get cheaply and quickly to places where we can tap the vast resources of space, we need the industrial tools to do so. Alas, no one seems to be working on any of this home(planet)work backlog.

The "rocket science" portion of this agenda, we must leave to those with expertise in those areas. What we'd like to talk about is the vast, unexplored potential for making real money now, developing processes and industries to meet the common unexplored resource challenges of good old terra firma Earth and of sundry worlds in space alike.

The considerable "bricks & mortar" portion of Earth's economy, which will never disappear or become irrelevant, has been built entirely upon the tapping of "enriched" resources. It is obvious that it will be cheaper to mine rich veins of ore than more homogenized concentrations of the elements vital to industry. It is obvious, too, that if we are to have self-reliant settlements on space, that they must also be able to "produce" economically, the elements needed for their own industries. The hitch is, that concentrated ore bodies are a terrestrial asset which we are unlikely to find elsewhere in the solar system. No where else has there been billions of year of geological processing of a world's crust and mantle in the presence of water. Not even on Mars, where such processing may have started only to be nipped in the bud much too early.

Poor Ore Mining Technologies

For accessing necessary resources on the Moon, on Mars, and even on the asteroids (where there is an unsubstantiated widely held belief that concentrated ores may indeed be found), we need to develop mining, beneficiation, and processing technologies that are economical in unenriched deposits. Talk to a mining engineer, and it is likely that if you bring up the subject of "mining the Moon" or Mars, you will be greeted with a contemptuous, condescending put down. No one knows with confidence, how to "produce" metals or other elements from such "poor" ores economically on industrial production scales. To point to lab-verified pathways of getting oxygen, for example, is not helpful or useful.

We will see no self-reliant resource-using lunar or Martian settlements until we have such technologies. Give us CATS and we will still have nothing! Nor would a political turnaround of unrealistic proportions that would make a lunar or Martian "outpost" a confirmed agenda item change this situation. "Local Industry" beyond a few relatively easy and simple symbolic things, will not be necessary for the token outposts such a political miracle might put on the agenda. We must not assume that if NASA (i.e. Congress) did indeed reverse itself, it would undertake crash programs to develop such technologies.

There is another way, a very mundane way to get the job done. Sadly, space-enthusiasts in general are too much too impatient to sidetrack their efforts to indirect methods that may in fact be much more powerful. These very same "Poor Ore Mining Technologies" would be very useful on Earth, whether we ever do go on to open up the space frontier or not.

Consider Earth's economic geography. The distribution of iron ore, copper, bauxite (aluminum), uranium, and other elements vital to industry has in large measure predetermined which nations have thrived and which have not. Of course, other factors play vital roles: arable fertile soil, access to the sea, forests, and the enterprise quotient of the people.

Poor Ore Mining Technologies would usher a substantial equalizing force into the world economy. Soils everywhere contain abundant aluminum and iron, but not necessarily in the concentrations and in the mineral forms we "know how to" work with cost-effectively. Chemical engineers must blaze new pathways that balance favorably energy inputs, secondary marketable byproducts, and environmental impacts. Concrete specific proposals tailored to the

MMM Theme Issues: The Lunar Economy - Years 1-25 Dec 1986 - Nov 2011

mineralogical circumstances of the various candidate locations need to be made to local or non-local investors and partners that stand to profit. Some of these poor ore mining technologies may have direct or indirect application to the situation we will find on the Moon or Mars or elsewhere. But even where this is not the case, we will be building up a pool of people with a “can do” attitude to supplant the present unhelpful crowd of “can’t do” mining experts.

Molecular technologies under exploration by people like Steve Gillette of the Univ. of Nevada-Reno offer some real revolutionary promise of an end run around present mineral-cracking hurdles. When it comes to producing strategic elements that are much less abundant, like copper, zinc, silver, platinum, gold, etc. where a 1% ore is considered rich, bio-extraction technologies need to be pushed. Without concentrated ore bodies, such elements are often present in only parts per million [ppm], or even parts per billion [ppb]. Bioengineered bacterial cultures may be able to greatly beneficiate or enrich these ambient concentrations. Here on Earth, such technologies would make many nations less dependent on others, less subject to political blackmail.

Novel Building Materials

On the Moon, there are neither forests to supply us with wood, nor petroleum reserves to supply us with chemical feedstocks for the host of synthetic materials to which we are addicted. Even on Mars, with a carbon and nitrogen rich atmosphere and plenty of hydrogen at least in polar ice, bringing such traditional building materials and manufacturing stuffs on line will be a trick. But is the situation any different for scores of countries on Earth that do not have appreciable forests, or who cannot afford to make further inroads into those they still have, and without native oil reserves?

Glass-glass composites have been proposed, and lab-researched, as a promising option for lunar settlement industry. But if we learned to produce a versatile array of glass composite building products and manufacturing stuffs, that could be an immense aid to the economies of countries that must presently import vast quantities of lumber and other products. There would seem to be ample economic incentive for taking this exotic stuff out of the labs, make fortunes in doing so right here on Earth, and in the process develop, debug, and put “on the shelf” a ready-to-go industrial technology that could be a backbone of early lunar and Martian industrial settlements. We developed this idea in more detail in MMM # 16, June 1988. But while glass fibers are finding their way into new concrete formulations, no one has bothered to try to earn a buck by taking glass composites themselves beyond the laboratory curiosity stage.

Metal alloys are another area deserving more research. Most pure metals have poor performance characteristics and benefit greatly from inclusion of varying amounts of “alloying” ingredients. Yet it does not seem to dawn on most space supporters that the Moon’s considerable “on Paper” wealth in iron, aluminum, magnesium, and titanium – the four “engineering metals” – does not guarantee the easy and economic production of the various alloying elements we are used to using to improve the performance characteristics of each. Steel needs carbon, in poor supply on the Moon.

Aluminum alloys generally are rich in copper, a ppb (parts per billion) trace on the Moon. Metallurgists who step in to research more “frontier-feasible” alloys which are still “serviceable” may end up producing alloys with considerable marketability here on Earth.

Synthetic Chemical Feedstocks

Mars enthusiasts never tire of pointing out that the other planet is richly endowed with the elements that are the basic organic and synthetic building blocks: hydrogen, carbon, and nitrogen (oxygen being taken for granted as ubiquitous). But in fact, most plastics and other synthetic materials are normally not “made from scratch” but from nature-processed cooking ingredients more or less easily refined from oil and other complex petroleum reserves (tar, shale, etc.) We are spoiled. But at the same time, countries not blessed with such reserves are at the economic mercy of those who do have them. If economical “from scratch” methods of meeting such synthetic materials needs could be developed by chemical engineers of the

MMM Theme Issues: The Lunar Economy - Years 1-25 Dec 1986 - Nov 2011

organic-persuasion, this would be of great economic value for many nations. And, as always, the power to equalize is the power to make money.

Bob Zubrin showed the world that methane could be easily made from carbon dioxide by using a totally automated "Sabatier reactor". Apparently, the chemical pathways exist to make other simple organic molecules that could serve as synthetic feedstocks by a similar or adapted sabatier process. Applying such techniques here on Earth might prove profitable. If countries blessed with natural gas, but not with oil reserves per se, could build the equivalent of a petrochemicals industry upon the simpler rudimentary assets of air and natural gas, this could prove a powerful economic equalizer for them. And anything additional to methane that we can learn to produce by these techniques, will also have the happy effect of putting "on the shelf" pre-developed and pre-debugged technologies ready to go on Mars at a much lower cost to the frontier.

In the original oil crisis, research began into using certain plants to produce oils and other petrochemical-like feed stocks. There is money to be made here on Earth by pursuing such agricultural alternatives. And happily, many such advances will be useful to opening the Martian and lunar frontiers. We can learn to be much less dependent on wood, paper, and synthetic organic products. But if we are not to be confined to the constraints of a "New Stone Age" on the space frontier, alternatives to conventional petrochemicals must be developed. And we can make money here and now doing so.

"Biospheric" Technologies

Biosphere II was an attempt to come up with a centralized solution for biological life support. Though the specific experiment "succeeded" only by "cheating", in fact we learned much. The only thing that can be dismissed as a failure, is an effort from which we learn nothing. It is much easier to dismiss than to criticize constructively, and when reading such negative reports, one should always discount for the temperament of the reporter.

Beyond Earth, settlements must re-encradle themselves in mini-biospheres that each settlement must establish, grow, and maintain. This will entail the unprecedented challenge of "living immediately downstream and downwind" of oneself. Pioneers in space will not pollute because, unlike us spoiled terrestrials, they cannot "get away with it," putting off pollution problems to the next generation.

But to attempt to do this in a centralized way is just as ineffective as are centralized methods of growing and control-ling economies. Modular "market" techniques must be the basis of any effort to establish, grow, and maintain space frontier biospheres. Systems that treat human wastes at the origin and greatly reduce any residual problem that must be handled on a larger scale, are much better suited for non-ivory tower communities of non-static size.

In fact, many people are experimenting with "living machines" and other techniques to integrate plants, air quality maintenance, and waste treatment in unit-sized systems. Such an approach will not only make city-size biospheres a more practical prospect, but will also enable appropriate-size life support systems for spacecraft on long deep-space journeys. We need technologies that are "scalable." In contrast, solutions addressing fixed, static size situations are not helpful at all.

The terrestrial profit prospectus of modular biospheric technologies is immense. In the last few decades we have seen the emergence of gargantuan urban complexes in the third world. For the most part, such cities have grown and continue to grow faster than urban utilities can add capacity to keep up with them. The pressure on centralized water treatment facilities is unreal, and the loser is public health. Inexpensive ways to tackle human wastes home by home, unit by unit, that freshen interior air, and provide additional sources of food, would do much to make such monster "blob" cities more livable. There is a market! Let's make money now, and learn how to do space right in the process.

The Gospel of "Spin-up"

MMM Theme Issues: The Lunar Economy - Years 1-25 Dec 1986 - Nov 2011

The traditional fare of the space faithful is what has long been known as “spin-off.” NASA spends hundreds of millions or even billions of dollars developing new materials and technologies that the agency needs for use in space, all at taxpayer expense. Then these technologies are made available to industry at large, providing the usual litany of “benefits for the public” of space research.

“Spin-up” would take the opposite path. Enterprise would brainstorm technologies deemed vital down the road in space for their potential Earth-market applications, so as to make money now. The frosting on the cake is that technologies also needed on the space frontier, would be predeveloped now at the expense of the consumer, rather than the taxpayer (YES, there is a world of difference in this distinction), and would be ready in time “ready to go” and at relatively low cost to those who will in due course attempt to open the space frontier to genuine self-reliant local resource-using communities beyond Earth’s biosphere and atmosphere.

“Spin-up” is a more economical and efficient way to get the research done in a timely fashion. It is the only path not dependent on uncontrollably fickle political tides. And in so far as it is consumer-user financed rather than tax-payer-forced, it is a more moral way to achieve “minority goals” such as ours.

But above all, the “spin-up” route is the only sure way to get the job done. To rely on the traditional route means putting all our eggs under a hen that is not motivated by instinct or any other reliable force to hatch them. We have complained before that those who want to open space by political coercion are abdicating the responsibility for the fulfillment of our dreams to those who do not share them, and cannot be made to share them.

If you are blessed with the talent to be an entrepreneur, consider that getting involved in pioneering some of the terrestrially useful technologies needed also in space may do more to guarantee the timely opening of the real space frontier than any amount of seemingly more direct involvement in micro-satellites and micro-launchers.

We do not expect those with electronics and propulsion expertise to get into totally different fields. Each of us must do our thing. Rather, we want to encourage and set loose the untapped talents of others who have not realized that they have a potentially powerful role to play, however indirect. The important thing in opening space is not instant gratification. It is well-targeted patient hard work.

If you are a young person not yet established in a career, consider chemical engineering, poor ore mining technologies, new materials science, “from scratch” synthetics production, bio-extraction technologies, molecular mining technologies, experimental agriculture, and modular environmental systems as rewarding fields in which you can make a difference, both down here and out there.

Rocket science can take us to other worlds. It cannot enable us to do anything useful once we get there. Iridium may have failed. It was a detour. There are other, ultimately more powerful and profitable ways to build up to a space frontier economy. Do not waste a moment wallowing in discouragement at recent setbacks. In the end, they won’t matter. PK

MMM # 135 May 2000

Cast Basalt: Startup Industry With Two Great Tricks

There is a growing, newly reinvented cast basalt industry in Germany, Spain, Britain, and the United States that is producing two types of products that will be very useful in the early

lunar settle-ments: abrasion-resistant pipes & material handling (think regolith-handling) equipment [**Left below**] as well as countertops, and decorative wear-resistant floor and wall tiles [**Right below**]. These talents make a cast basalt industry a top priority. For more, **see following article**.



Cast Basalt

An Industry Perfect for a Startup Lunar Outpost

By Peter Kokh

Perhaps a decade ago, I read a one-liner in an encyclopedia about a “cast-basalt industry in central Europe.” Immediately the need of early Lunan settlements to hit the ground running with appropriate-technology industries came to mind.

Basalt! There is plenty of it on the Moon. The great flat lava flow sheets that fill the maria basins are essentially basalt. The regolith surface of these “Seas” is but meteorite-impact-pulverized basalt.

There is plenty of basalt on Mars as well. The whole Tharsis Uplift area (Arsia Mons, Ascraeus Mons, and Pavonis Mons) is basaltic, as is Olympus Mons. And there are other lava sheet and shield volcano areas on Mars rich in basalt.

The idea of just melting the stuff with a solar concentrator furnace and then pouring it into molds to make useful products seemed a no-brainer. Even if cast basalt had (an assumption) low performance characteristics, there would be plenty of things needing to be made in the Moon settlements for which high performance would not be an issue. Table tops, planters, paving slabs came to mind.

But for years, I could find nothing more than that teasing one liner. Five years ago, I asked friends in the basalt-rich Pacific Northwest if they knew of any such industry in their area. This did not turn up any new leads. That was then. Today we have the Internet, and I finally returned to the issue and did a simple web search. Voilà!

There is a thriving cast basalt industry here on Earth, and like most “materials” industries these days, it is vigorously reinventing itself. “And the envelope, please!”

Cast Basalt’s Abrasion Resistance

Casting basalt in itself is not something new. People began to experiment with it in the 18th century. Industrial manufacturing with this material began in the 1920s when Cast Basalt began to be used as an Abrasion-resistant, Chemical-resistant lining. The material is crushed, and heated until it becomes molten at 1250°C [2280°F], then cast in molds (e.g. tiles), or centrifuged into pipe shapes. The cast items are then heat treated so that the material crystallizes to take on extreme hardness (720 on the Vickers scale where mild steel is 110; 8-9 on the Mohs scale where diamond is 10). The density is 2.9 g/cm³.

Two companies in Europe produce abrasion-resistant items for use in material handling (think of handling abrasive regolith moon dust on the Moon!): pipes, pipe fittings, cyclones, conveyor parts -- the list of applications is quite long. Both companies ship worldwide.

MMM Theme Issues: The Lunar Economy - Years 1-25 Dec 1986 - Nov 2011

- Kalenborn Kalprotect, Vettelschoss, Germany <http://www.bulk-online.com/YD/Data/Co/09254.htm>

This company's trade name for its cast basalt product is ABRESIST "one of the most tried-and-true materials for wear protection. It is high sliding, has a low coefficient of friction, good impact resistance, and very good chemical-resistance. More than 1 million of meters of pipe have been lined by Kalenborn with fused cast basalt." Kalenborn also makes specially resistant products out of other materials such as fused cast carborundum (a form of Alumina, Al₂O₃) and high alumina ceramics, both of which can also be derived from the lunar regolith.

- Antidesgast, S.A. Barcelona, Spain <http://www.antidesgast.com/english/castbasalt.htm>

This company makes a similar line of products under the trade name of Basramite, "the world standard for ash slurry pipe-work at fossil fuel power stations. An all round cost effective, adaptable lining material, extending the life of equipment subject to erosion."

Abrasion-Resistant Materials on the Moon

One of the strongest misgivings frequently expressed about the feasibility of industrial operations on the Moon is the very abrasive and "hard to handle" nature of regolith or moon dust. Cast basalt as a material up to the job of handling moving regolith in industrial and construction operations seems a "lunar" solution made in heaven. Are there any qualifications? The chemical analysis of the basalt used by Kalenborn includes the expected aluminum, silicon, iron, and titanium oxides, but a higher than typical percentage (on the Moon) of manganese, sodium, & potassium oxides. These elements are found on the Moon, however, in parts per thousand, not in parts per hundred.

What we need is a lab test of the performance characteristics of a similarly melted, cast, and annealed small Apollo sample of real lunar mare basalt regolith. This research would make a great thesis for a student majoring in inorganic materials.

An early lunar cast basalt industry producing abrasion-resistant pipes, troughs, and other parts of sundry regolith-handling equipment would seem to take priority over everything else. We have to handle regolith to produce oxygen, to produce iron and steel, to produce aluminum, to produce ceramics, to produce glass. Regolith-handling equipment will be necessary to emplace shielding, to excavate, to build roads. It will be needed to handle regolith being heated to harvest its gas load of hydrogen, helium, nitrogen. Yes, we could use imported items for this purpose. Yes, we could use non-resistant items and keep replacing them as they break down and wear out. But that does not seem to be "logical."

If we are to diversify lunar industry in a logical progression, cast basalt seems the place to start, with an in situ demonstration as task # one.

Cast Basalt Flooring Tiles

Two companies, one in Britain, one in the U.S., use cast basalt to make "durable but decorative" flooring tiles in a variety of shapes.

- Greenbank Terotech Ltd., Derby, UK <http://www.greenbanktl.demon.co.uk/>
- Decorative Cast Basalt Sales, Inc. Webster Springs, WV <http://www.decorativebasalt.com/>

Greenbank Terotech and DCBS import Czech basalt to produce "Volceram [volcanic ceramic] Flooring Tiles" of "natural beauty and practicality." Cast Basalt is now being used extensively by architects and designers for use both as a industrial floor covering in heavy industry and as decorative flooring in commercial, home and retail settings. The skillful 16-21 hr annealing process brings out all the natural beauty that gives the basalt tiles a unique appeal and a natural shine without added glazing.

For commercial and industrial use, their hardness ("four times harder than rock, one of the hardest ceramic materials known") and imperviousness to acid and chemical attack make the 25 mm (1") thick tiles very attractive. They "take a beating", retain their appearance, require little maintenance.

MMM Theme Issues: The Lunar Economy - Years 1-25 Dec 1986 - Nov 2011

This nonporous “industrial strength” tile is nearly indestructible, and chemical-resistant. Yet in the annealing process they acquire a natural beauty that rivals more common ceramic tiles that have to be glazed. This makes them equally perfect for kitchens, bathrooms, halls, patios, etc. Tiles are produced in standard squares, florentine, charlotte, hex and other shapes, and in several sizes to allow a great diversity of floor and patio patterns.

Role of Tiles in Lunar Settlements

Modular habitat structures, will have to have circular vertical cross-sections to distribute the stresses of pressurization equitably, whether their overall shape be that of a sphere, cylinder, or torus. This means a flat floor will have to be constructed over a bottom cavity. This dead space could be used for storage, water reservoirs, utilities, and utility runs, etc. -- an efficiently compacted “basement”.

An open-spaced flanged-grid subfloor, of some non-rust alloy or of glass composite, could rest on metal, concrete, or glass composite joists. The thick cast basalt tiles could then be set into the grid without mortar, as illustrated below.

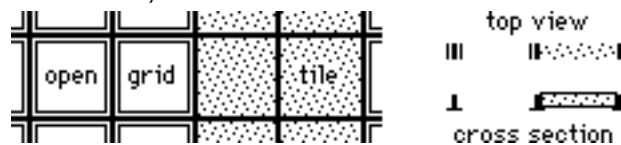

Larger cast basalt tiles could be used for floors of factories, commercial enterprises, schools, etc. And why not also outside, set upon a graded and compacted bed of sieved regolith, to serve as a sort of porch or deck at EVA airlocks, both personalizing such entrances and helping curb import of dust into the interior. One can think of many uses!

Cast Basalt Tiles for Walls and More

The floor tile possibilities and applications seem endless. But cast basalt tiles could be used for more than flooring. Without wood for the customary “woodwork”, plain, textured, and/or decorative tiles could be used, in the role of jamb, casing, baseboard, ceiling cove moldings, even wainscoting. In MMM #76, June, 1994, we suggested the use of “ceramic” tiles for these applications:

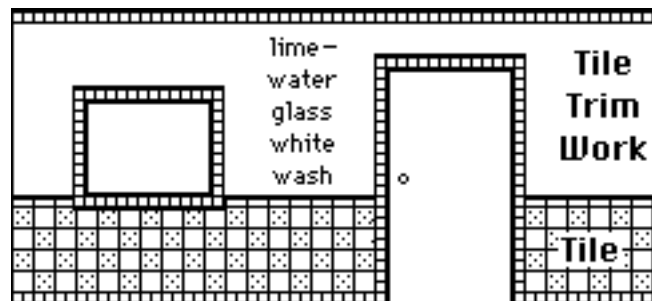

In the illustration above, ceramic tiles are used to provide trim borders. While the seemingly endless variety in color, pattern, and glazing now available on Earth could not easily be produced on the Moon, a variety of hues from the lunar palette (regolith grays, oxide colors, stained glass colors) should be available either unglazed or in soft satin glazes. Tile in contrasting sizes, and coordinated colors and patterns, would make a good companion wall finish, as would simple white-wash or waterglass-based paint.

Cast basalt then seems to be the right material with which to kick-start diversified lunar industries. On the Moon, where the regolith particles are quite sharply angular because they've never been subject to water- or wind-weathering, we will need a family of abrasion-resistant regolith handling items before we launch our lunar concrete, ceramics, metal alloy, our glass, and glass composite industries. Cast Basalt looms as a cornerstone of lunar industrialization.

Once we have advanced to the processing and manufacturing of these other building materials, we will be able to start providing habitat expansion space from made-on-the Moon

MMM Theme Issues: The Lunar Economy - Years 1-25 Dec 1986 - Nov 2011

materials. Then once again, cast basalt, this time molded into durable and decorative tiles, will help in furnishing the interior spaces of these new “elbow room” modules. Cast basalt will be a cornerstone lunar industry. MMM

MMM # 144 April 2001

Stay-at-home Shadow Settlers Forging a “Critical Mass” of Brains & Skills by TP – “Tele-Participation” Greatly reducing labor costs on the Moon

By Peter Kokh

From time immemorial, those who would set out to pioneer new territory were very much on their own. If they found that they needed something that they had not thought to bring with them, they either had to provide it from scratch where they were, or do without. They were also limited by their own skills. It was a rougher world, and only the most resourceful became established in their new homelands.

Gradually trade arose and neighbor peoples could share tools, goods, resources, knowledge and skills. Trade burgeoned, leading to a widely shared and richer material and cultural civilization base.

Today we have the telegraph, telephone, radio, television, and the Internet. Undersea cables, microwave towers, and communications satellites make the shunting of information flow easy and virtually immediate. The space pioneers of tomorrow, at least those who pioneer within reach of this overmind, will have a leg up on their predecessors.

Settlers bound for the space frontier will not be able to succeed with the much simpler tools and skills that allowed earlier generations of pioneers to prevail. The shores across the space ocean are alien by any standard of common human experience.

Yet the pioneers will be few, their settlements small. How can a few people -- a dozen, a hundred, or even a thousand -- possibly possess the critical mass of skills needed to accomplish their phase b phase goals in any reasonable amount of time? The solution is simple. The people on the front lines, actually at the outpost location, can benefit from virtually realtime tele-participation of many more talented people on Earth -- “shadow settlers” if you will.

Two preview cases in point

You have probably seen the very successful 1995 Ron Howard film Apollo 13 starring Tom Hanks, Kevin Bacon, and Gary Sinise. Two days before the launch, Ken Mattingly (Sinise) was forced to stay behind on Earth because of possible exposure to measles (which he never got). This proves fortunate for all as Ken saves the day when the Apollo 13 crew faces almost certain reentry disaster. Ken works in the simulator until he finds a way for the crew to pull off the reentry sequence with the 16 amps of power available in the crippled Command Module.

Prior to that, the Apollo 13 crew is saved from suffocation in their own carbon dioxide when a surface team figures out how they can mate the more powerful square scrubbers in the Command Module with the round ones in the LEM, using only stuff they are known to have on board.

Or just for crises -- the ongoing struggle

But as important as a ground team with real time access is in crisis situations or repair and rescue, there is much, much more to be gained from a shadow team than that. The frontier is a place where almost everything we knew how to do back home does not work in the new setting. We have to find new ways to do almost everything. We have to learn to do without many of the things which we have always taken for granted. We have to learn how to confront new dangers and risks and to respond to them as if by second nature. Here are some of the areas in which the two few people on the frontier will need backup:

MMM Theme Issues: The Lunar Economy - Years 1-25 Dec 1986 - Nov 2011

- Power systems dayspan & nightspan
- Pressurization problems & emergencies
- Dust control
- Field equipment maintenance
- Inventory management
- Biosphere management
- Water and air recycling systems & quality
- Thermal management & humidity control
- Agriculture, food production, crop health
- Waste processing, management, recycling
- Sound/acoustical management
- Exploration & field science
- Prospecting & mining
- Processing & chemical engineering
- Manufacturing
- Operations scheduling dayspan/nightspan
- Construction & expansion
- Engineering & automotive challenges
- Fabrication of new items & repairs
- Paperwork & bureaucratic necessities
- Social interaction problems
- Stress problems
- Medical situations: illness & trauma diagnoses
- Arts & crafts media development
- Documentary production & broadcasting
- Continuing education

On the frontier, despite the complexity of the problems and challenges we face, we will always be in short supply of people to throw at them. It would seem a hopeless task. To meet an unprecedented flood of new challenges with way too few people.

We cannot afford to put a critical mass of skills and talent on location in the near term. So how are we going to meet the challenges “anyway?”

The answer is that we only need a few people on the front line, in direct contact with the situation, so long as they have immediate and continuous access which can be anywhere that the means of “live” real time communication can support. For those trying to establish a lunar frontier settlement, shadow teams on Earth will do just fine.

If all we need is your brains, not your hands, you can help from Earth, just 3 radio response seconds away from Lunar Nearside.

Brain and Hands -- mente et manu -- as it summed up in Latin. We need both in the real world, but not always in the same degree of immediacy. Many problems yield to realtime brainstorming by a team of experts. So long as they have all the particulars, so long as they know the special and peculiar circumstances that affect the situation on the Moon, so long as they can converse and gesture and draw with a virtually real-time interplay, they don't have to be physically present. Of course, there comes a time to call an end to brainstorming and to make decisions among options.

In the early phases, “Mission Control” on Earth will insist on having the last word. Eventually, those on the front line, whose fate lies in the balance, will prevail in the thumbs up/ thumbs down decision. It is they who must make the solution work, they whose lives are on the line. As the settlement grows and with it a stable, permanent population, the move to “home rule” will be inexorable.

MMM Theme Issues: The Lunar Economy - Years 1-25 Dec 1986 - Nov 2011

And for those extras necessary for morale We have spoken before of the vital role development of frontier arts and crafts will play in getting the pioneers to “feel at home.” Once they can express themselves creatively using local materials and resources, in however crude, amateurish, rustic, and experimental sort of way, that will make the frontier seem that much less alien. The support of a host of artists and craftsmen at home supplied with lunar materials to help identify by trial and error what will work will greatly speed up the rise of lunar art forms.

The thing to remember is that while in theory, the media stuffs with which to paint, make art glass, pottery and ceramics and sculpture exist on the Moon, they will take some time to develop local sources of ready-to-use ingredients. Nor will these all come on line at the same time. This means that we can expect “Periods” in each of these lunar art forms in which artist and craftsmen struggle with less than they would like to work with. It will take a great deal of patient experimenting, often without the rewards of success or the sense of progress before there are satisfying results. Now the pioneers will have limited free time for this. If much greater numbers of artists and craftsmen on Earth can be turned loose on lunar simulant materials, even on some of the real stuff to lay with, they might be able to advance some primitive lunar-appropriate art forms suitable for each phase in the development of local sources.

This will free those on location to begin producing real art, however primitive, and to practice refining their personal styles instead of getting discouraged, spending too much time with experiments that could have been done beforehand.

This is essential. for the sooner outpost pioneers can produce creations from local materials, the sooner will the pioneers begin to feel “at home.” In the long term scheme of things, the battle of morale is as important, if not more so, than any other.

Other artists could test our art forms the pioneers could try using waste biomass products from the planned agriculture unit. They might even recommend the inclusion of certain plants on the merits of especially useful products and extracts.

Still others could take a look at other waste and surplus materials accumulating in the outpost and suggest ways artists and craftsmen could use them creatively. These can include scrap metal, metal fittings from the machine shop, waste packaging stuffs and more. Waste not, want not. perennially, cash-poor artists have always been especially creative with materials that are laying around “free.” For inspiration, check out these pages online:

- http://www.moonsociety.org/chapters/milwaukee/painting_exp.html
- http://www.moonsociety.org/chapters/milwaukee/painting_exp.html#laamp
- <http://www.asi.org/adb/06/09/03/02/091/waterglazing.html>

Who goes to the Moon? Who stays on Earth? The too easy answer is that those who are best with their hands are needed on location, while those who are best with their brains can provide adequate support from Earth. Of course we don't need a bunch of dolts or automatons on the frontier. In fact, those on Earth must be able to go through the motions of whatever it is that those on the Moon are trying to do. And those on the Moon need to accurately describe their problems. We need brains and hands in both locations!

Those with a lot of back-up knowledge and related hands-on expertise can coach from the rear. With high-definition television and with teleoperated controls equipped with sensors that provide tactile feedback, stay-at-home experts will have all the immediacy to the situation that they need to assist effectively.

The virtual shadow outpost

Nor will all the shadow settlers have to be physically in one place. As long as they can videoconference, in most situations, that will work fine.

There will, of course, be need for Mission Control problem solving clusters of technicians provided with physical simulations of the problem areas at issue: equipment, controls, systems, etc. For example, in the Apollo 13 example given above, where a team had to figure out how to connect A with incompatible B given the spare equipment and items and tools actually available on location.

MMM Theme Issues: The Lunar Economy - Years 1-25 Dec 1986 - Nov 2011

Back on Earth, there will be an all but endless pool of people to throw at trial and error problem solving -- to free the few pioneers to try pretested methods and effect solutions. If all these people were actually on the frontier, it would be hard to keep them busy and earning their tickets. It is no problem to keep a pool of people on call, on Earth, without a situation of "too many cooks spoiling the broth."

Settler Recruit Training Camps

We can assume that there will be a settler recruit training camp, or if "settlement" is not yet the operative word, a training camp for those hoping for duty assignments in the lunar outpost(s). These men and women will be especially motivated to assist those already on location by simulation exercises, pioneering and debugging new ways of doing things, lunar appropriate art forms, lunar-style agriculture and horticulture, and ... the list goes on.

The recruits can tackle items that have not come up yet, to help prepare for when they do. They are likely to train in an Earthside near duplicate of the lunar outpost where simulations in realistic lunar situations can be run.

They can help with paperwork and bureaucratic duties, working on data and files emailed from the Moon, in order to free up those on the Moon for get-your-nails-dirty front-line tasks. They can be available for Internet chat or radio/TV jam sessions. They can do other remote support and service tasks. The important point is that in the recruits we will have an eager population that does not need to be paid in cash or credits for their work on behalf of the people already in the lunar trenches. Of course, their diligence will be duly noted when it comes to final selection time for the next transport out.

Spinning-Up

In previous articles and editorials [e.g. MMM #65, "Career Choices in "Spin-Up" Industries"] we have tried to push an important piece of space counterculture: "spin-up" as opposed to "spin-off." Instead of extremely expensive crash programs to develop technologies needed on the frontier, then justify the expense to the masses on the merits of alleged "spinoff" goodies, we could take an entirely opposite approach.

We look at the new technologies we will need on the frontier at various future stages. Next we brainstorm these technologies for possible profitable terrestrial applications, and develop business plans to develop them on that basis. The idea is to make money now with the frosting being that we will be putting "on the shelf", technologies that can be used as is. adapted to the frontier when we need them. Some examples:

- **glass-glass composite technologies** (possible Earthside markets: high end furniture; architectural elements; boat hulls, etc.)
- **"poor-ore" mining technologies** (would allow nations "poor in mineral resources" to stand on their own.)
- **dry water-free or water-reduced processing technologies** (would help save the environment by reducing toxic runoff)
- **clay-free silicate ceramics**
- **water stingy concrete (steamed concrete)**
- **small, modular sustainable biospheric systems**

One could brainstorm endlessly, just looking at the challenges pioneers will face in trying to build a self-reliant industrial lunar settlement.

While this is certainly an important way that would-be entrepreneurs can help pave the way, it is a much more ambitious and long-term commitment than the kind of "shadow settler" activity we are trying to describe in this article.

The com link -- the most vital tool of all

The contribution of shadow settlers will only work via the "com link" which thus becomes the one most essential system, the backbone system needed for establishment of beachhead communities beyond Earth. Call the com-link the "umbilical cord." if you will. Call the stay-at-home BLM solving matrix of shadow teams the "placenta." Call the actual settlement in the process of becoming established on location the "fetus."

MMM Theme Issues: The Lunar Economy - Years 1-25 Dec 1986 - Nov 2011

The settlement's weaning from this teleparticipation will be gradual, as it grows, becomes more confident, and successfully handles ever more of its problems and challenges on its own. To make a settlement self-reliant and viable, you need a large critical mass of skills and talents. In the period where it is just getting established, we can expect to have only a nucleus of such a critical mass on location with the bulk of the rest contributing from 3 radio response seconds away.

That works for the Moon. What about for Mars? The Martian pioneers will not be able to engage in "real-time" brainstorming sessions with their counterparts and expert support teams on Earth. Given the 6-40 minute response time that will never shorten, the best we can expect is the less intense level of brainstorming that goes on in email discussion groups. Earth-based and Mars teams can trade video monologues. It will be cumbersome. If there is a forward base on Deimos, the people stationed there can be of some limited real time assistance. Martian settlers will be operating at a distinct disadvantage in comparison with the Lunans.

Recognition

Certificates, awards, plaques, ribbons, and medals should all be considered for awarding to those who perform this yeoman support service on Earth. These people, whatever their field, will be vital parts of the settlement team as it attempts to establish a successful beachhead on an alien shore. That they remain physically on Earth does not lessen the importance of their work.

"Honorary Citizen of Luna City" -- "Pioneer at large" -- "Ancestor of Lunan Settlers" -- such titles might be awarded in recognition of outstanding service with suitable public ceremony and recognition. The names of those so honored should be inscribed in memorials within the settlement. As the old saying goes, "they also serve who only ..." <MMM>



MOONGAS or "As the Moon Burps"

By Peter Kokh

Sources:

<http://www.spacer.com/news/lunar-01b.html> - <http://www.spacer.com/news/lunar-01c.html>

David Darling ALS TLP Project - daviddarling@daviddarling.info

MMM #31 DEC '90 "Moon Glow" [incl. in MMMC #4] Alan Binder (personal conversations)

The Moon seems totally dead

However, Apollo mission scientists, suspecting that there might be some residual outgassing from the Moon, equipped the Apollo 15 and 16 Command Modules orbiting the Moon with alpha particle spectrometers to detect radioactive emissions from any traces of radon gas that might be coming from underground decay of uranium, and released through lunar surface vents as part of (comparatively) bigger flows of more orthodox gases such as carbon dioxide or argon.

Meanwhile, for decades, amateur observers have been reporting fleeting, non-permanent local changes in color (reddish) and shade from various areas, most notably around the craters Aristarchus and Alphonsus. These temporary changes they noted as "Transient Lunar Phenomena" -- TLP.

MMM Theme Issues: The Lunar Economy - Years 1-25 Dec 1986 - Nov 2011

Lunar Prospector was equipped with an alpha particle spectrometer to follow up on these earlier indications. After much work in the past two years sorting out the faint signals from the unexpected amount of noise coming from the very active Sun during the Lunar Prospector mission in 1998- 9, scientists have identified the signatures of two radioactive gasses: radon and polonium. These gases are produced as byproducts of radioactive decay of uranium, an expected component of the lunar crust, as it is of Earth's crust.

Fractured Crust and Trapped Gas Pockets

The upper 10-20 km (6-13 miles) of the Moon's crust is fragmented and fractured, allowing trapped gasses to leak out over the eons. These leaks increase during moonquakes caused by continued settling of the lunar crust or by fresh impacts. At some deeper level in the crust there may be high pressure pockets of gas left behind as the solidification of the crust advanced downwards. This should include carbon dioxide, carbon monoxide, and other volcanic gasses.

Bear in mind, that lunar volcanic gasses will be dry, without water vapor, and given that the Moon is less oxidized than Earth (note that iron is present on the Moon mostly in ferrous rather than ferric form), we would not be surprised if carbon monoxide, rather than carbon dioxide, is the dominant gas. There could be sulfur and nitrogen compounds also.

Scientific Significance: Uranium

Of course, lunar scientists are interested primarily in the "scientific" significance of the new readings: they confirm the expected presence of uranium in the crust. Another Lunar Prospector instrument, the gamma ray spectrometer, had traced abundances of another radioactive element: thorium.

Radon 222 and Polonium 210 each have distinctive signatures. As radon has a half-life of four days, while polonium has a half-life of 21 years, sniffing radon indicates very recent outgassing, while detecting polonium indicates activity within the past two decades. Based on Lunar Prospector findings, uranium deposits are more widespread, particularly below the Nearside maria, than had been thought.

Prime Locations:

The region around the crater Aristarchus seems to show the most activity, and this has been long suspected. Aristarchus looms as the prime destination for a future manned geological mission (before Nixon canceled it, Aristarchus was the intended target for Apollo 18.)

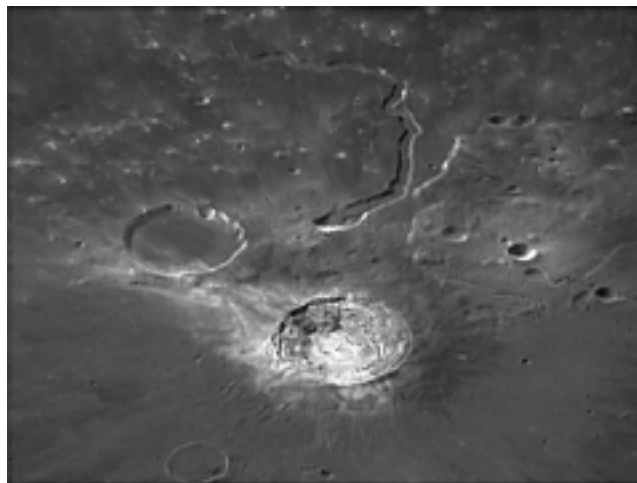

Aristarchus: the brightest spot on the Moon, is a crater 40 km (24 miles) across, at 23.7°N, 47.4W.

The tad smaller crater with the dark mare-filled floor is Herodotus. Schroeter's Valley is the very large lava-carved rille.

MMM Theme Issues: The Lunar Economy - Years 1-25 Dec 1986 - Nov 2011

Other emission areas are Mare Fecunditatis (Fertility) and around the Sinus Medii (Central Bay.) As expected, no traces have been found over the farside, where the lunar crust is especially thick.

Economic Significance: Uranium

Those of us who see the continued scientific exploration of the Moon as vital to laying the foundations for future industrial settlements built upon lunar resources, can be forgiven if we are not that excited about radon and polonium. Their industrial significance is relatively slight.

Uranium is a different matter, though it remains to be seen from “ground truth” on site prospecting how rich these deposits are, and whether a future lunar nuclear fuels industry will be based on natural uranium, or upon the Moon’s abundant thorium deposits.

On Earth, thorium is much more abundant than uranium and we can expect the same ratio on the Moon. There is more potential energy in the Earth’s thorium reserves than in all the world’s fossil fuel reserves combined: coal, oil, gas, tar, shale, methane-rich sea bottom oozes, etc. This is because thorium can be processed into fissionable U-233 in a fast breeder reactor. [see articles from MMM #116 and #123 above.]

The choice between uranium and thorium as nuclear feedstocks will depend on several things: location, richness of deposits, ease of mining, safety, capital equipment investment needed, and production goals. At this stage of the game, it is our best use of effort to advance definition of both options, rather than risk a premature pick of the winning route.

Economic Significance: Other Gasses

In the near term, the most important find would be trapped gas pockets rich in nitrogen and/or carbon. Both elements are critically deficient in the lunar regolith, despite some fraction contributed by the solar wind over the eons. These elements, rather than hydrogen, may turn out to be the “pinch-point showstoppers” for extensive lunar settlement and development.

While it is very likely that a “ground truth” probe to the suspected lunar polar ice-deposits in permanently shaded craters, will find that the water-ice has included carbon and nitrogen ices -- after all, the source of these polar deposits are comets impacting the lunar surface over the ages -- it will be most encouraging if future prospecting and drilling finds trapped subsurface gas pockets of volcanic origin with economic concentrations of carbon monoxide and nitrogen. (Carbon dioxide would be a surprise while water-vapor or steam and methane would be most unexpected.)

Currently, we cannot detect such gasses with orbiting instruments. We’ll probably have to await onsite drilling in promising areas where radon and polonium leaks have been documented. Meanwhile, we can hope for the best.

Confirmation of tappable carbon oxide and/or nitrogen deposits would lift many of the constraints under which we now expect lunar settlement to struggle. If we have to be stingy with nitrogen, which we need primarily as a buffer gas for breathable atmosphere, we can expect the following consequences:

- Lower atmospheric pressure standards with reduced nitrogen partial pressure
- Lower ceilings to reduce the total tonnage and cubic feet of nitrogen needed: forget those domes and other vaulted ceiling megastructures

If carbon is only available from solar wind deposits in the upper layers of the regolith, we can expect that:

- Tax and other disincentives to “withdrawing” carbon-rich items from the biosphere and food production cycles: wood will be priced like gold or diamond: paper, plastics, organic and synthetic fibers will be restricted to uses for which there are no substitutes -- one spartan scenario is cotton for underwear next to the skin but fiberglass for outerwear, anything not next to the skin
- Incentives to develop silicone-rich substitutes, all of which still have some carbon, though

MMM Theme Issues: The Lunar Economy - Years 1-25 Dec 1986 - Nov 2011

proportionately less.

However, there is a good chance that we will find comet-derived carbon-bearing ices in the polar water-ice deposits: frozen carbon monoxide, carbon dioxide, methane, as well as nitrogen and sulfur oxides. If this is confirmed, the above spartan conditions will already begin to be relaxed. But other than polar-cold-trap and gas-pocket sources of carbon and nitrogen, the lunar pioneers will need to foster trade with outposts on Deimos or Phobos, for example, or other cheaper sources that the bottom of Earth's gravity well.

If we can't use radioactive tracers like radon to detect carbon oxide gas pockets, how might we go about it? Ultra sensitive gravimetric sensors able to map even slight negative mascons may be a help. We might also station carbon and nitrogen sniffers all over the place and hope to get lucky. Future lunar prospectors will be looking for more than ores.

MMM

Measure a man (organization) by the opposition it takes to discourage him/

Judge a man not by where he has come from, but by where he is headed toward.

For a culture to be successful,

It has to teach its children to want to do what they have to do.

- Margaret Mead

Any Question is best answered with "it depends."

Everyday people, when challenged, are capable of the most extraordinary thing

MMM # 149 October 2001

Homestead  **Gardens**
& Early Cottage **Industries**

By Peter Kokh

Revisiting our Assumptions

This month we want to delve into the economic benefits of equipping lunar homesteads with garden spaces. But first, let's revisit our assumptions. The common expectation that the first people to return to the Moon will be living in very spartan and cramped quarters is most probably right. Habitat space will be brought up from Earth, sized to fit either the Shuttle payload bay or topmount fairings of big boosters. We could sneak in some elbow room via telescoping modules or rigid-inflatable hybrids of the TransHab or Moonbagel types. But chances are that extra elbow room would be used for operations, lab-space, storage, and other non-private purposes.

It will only be once we have mastered the many tricks of handling mischievous lunar regolith and processing it into suitable building materials and coming up with modular architectures that permit fast, manpower-light construction with quick occupancy that personal quarters will start becoming more truly livable on a rest-of-one's life basis.

MMM Theme Issues: The Lunar Economy - Years 1-25 Dec 1986 - Nov 2011

Once we reach this threshold of learning how to live off the land, the holy grail of lunar construction will become “spaciousness”. Here on Earth, we can tolerate closer quarters when need be because we can go “outside” if needed to get relief from interpersonal pressures. Walk out the door and go for a walk, putter around in the garage, do some gardening. On the Moon, all our getaway relief spaces will have to be in pressurized structures. If we want a garden, be it for growing food or just for enjoyment, that garden has to be “indoors” and lit either by artificial light or by channeled sunlight, or both.

Last month, we talked about the “Earthpatch” or “patch of Old Earth” atrium garden space as the heart of the lunar homestead. It will take a while to get to that point, But make no mistake, if we do not reach that stage of “gracious living” in due course, the prospects for permanent, healthy human civilization on the Moon are not good. Hardships that are endurable on a short term basis become unbearable if there is no real hope of ever getting past them.

A garden is what one makes of it

Not every homesteading family on the Moon who gets to move into a new modular home equipped with an atrium garden space is going to want to be growing fruit, vegetables, herbs, and spices. Many, no doubt, will be quite content to enjoy relatively carefree greenery and some perennial flowers,

perhaps. (and why not songbirds?) Even purely ornamental gardens will serve the essential purpose of producing sweet fresh air and pretreating waste water.

Some, however, will be anxious to try their hands at growing vegetables and fruits not planted in the settlement farms, in search of a more interesting diet and more varied menu choices. Among these will be some “green thumb” types who are good at it, good enough to produce surpluses worth selling to others as raw fresh produce, canned goods and preserves, juices and ciders, or other garden byproducts.

So while the original dual purpose of having an “Earthpatch” is to provide healthier homes and citizens with higher morale on the one hand, and to ensure that each home functions as a modular organic cell of the settlement biosphere at large, for some, these homestead gardens, “yours to do with as you please”, will become a real foot in the door for off hours and weekends “cottage industry.”

Cottage industries enrich the lives of those who engage in them, provide the benefits of harvest to themselves, and by sale or trade (barter) enrich the lives of others. They also provide real personal satisfaction that may be lacking in their “day jobs.”

Roots of Opportunity: the Quest for Variety

The settlement agricultural areas are likely to take a minimalist approach: providing a balanced diet in as efficient a method possible. That is likely to involve a relatively short list of basic crop “staples.” While these staples will provide for all nutritional needs for the body, we all know that there is much

more than that to human eating patterns, and there always has been. Food has to be more than nutritious. We want it to be tasty, and reasonably varied. But at first, providing for varied, interesting menu options and “cuisines” will rank as secondary.

This understandable priority will leave a lot of pioneers wanting more, and wanting it badly. Of all the pleasures we humans enjoy, the most regular and most consistently valued, is good tasty food with plenty of variety. The vacuum left by the short “basic” list will create an insistent demand which will surely intensify over time. Yet importing treats and specialties will be prohibitive. But we can expect to see some freeze dried specialties make it to the tables of pioneers for special occasions and holidays.

Given this situation, anything for which there is demand but is not grown in settlement agripod units, will lure would be entrepreneurial gardeners provided with a gardenable plot. This will include more fruits, additional vegetables, herbs, spices and seasonings, and beverage stuffs. The shortcomings of the settlement food production system will, in effect, create a vacuum. Nature, including human nature, abhors a vacuum. The appetite for more will become a necessity that will nourish a lot of inventiveness.

MMM Theme Issues: The Lunar Economy - Years 1-25 Dec 1986 - Nov 2011

Only one “climate” may be supported within the farms: tropical, subtropical, or temperate. Any of these choices will rule out many crops favorites. If it is possible to support special climates within homestead gardens, one could cultivate items in demand.

To be honest, it may be easier to raise strawberries and other northern food plants that require frost cycles in large separate agripods than in homestead gardens that are integral to living space. But given the incentive, we doubt it would be impossible.

Yet another factor motivating home pocket farming is that some who seek assignment to the farms may be attached to farming or gardening methods that can’t or won’t be practiced there. The settlement farms may be largely hydroponic, for example. In that case, the homestead garden could provide an outlet for those rooted in the soil.

The Market for Home Processed Food Items

The settlement farms may provide only “raw” produce. It is more likely, however, that in order not to waste fruits and vegetables with low “shelf appeal” yet perfectly nutritious and tasty, that basic “canned goods” items and other lightly processed staples will be available, and sought after. That will still leave a lot of room for specialty products, especially as herbs, spices, and seasonings become available. Thus some homestead gardeners may well concentrate exclusively on raising such taste enhancers to add to store-bought staples in canning homemade taste enhanced labels at premium prices.

We can expect special marketplaces to spring where would look for such specialty items (as well as home produced arts and crafts, and other cottage industry items). Cottage industries of all kinds will seek to fill the shortcomings of settlement stores.

Resources for Homestead Gardeners

Where would homestead gardeners get seeds and seedlings, soil additions, tools, special processing equipment and other things required to support this kind of in-home light industry? Keep in mind that while the settlement fathers may need to concentrate on a few basic crop staples, it is still in everyone’s interest that enterprise-grown supplements to this minimal fare be supported and encouraged. It should be settlement policy to provide a varied seed “bank” and provide needed tools – even importing such items until they can be manufactured locally.

Seeds, seedlings, and shoots may be available even for nonfood or food ingredient plant varieties. Increasing biodiversity within the settlement should be a major goal in its own right. So it would not be surprising if even those gardeners who are interested only in purely ornamental plants and flowers find official support and encouragement.

Cottage industry, however modest at first, is a primary pathway to economic diversification of the settlement. At first such efforts may arise mainly to fill local pent-up pioneer needs. But in time, many such enterprises could expand beyond their humble homestead beginnings to become major day job operations producing products for export. Keep in mind that anything produced on the Moon could likely be supplied to other off-Earth markets, such as tourist meccas in low-Earth orbit, at a real cost advantage over equivalent products shipped up the steep gravity well from Earth’s surface.

In the U.S. most state universities with agriculture departments have “Extension” programs supporting agriculture and horticulture. Even in its earliest phase, any Luna University should have such an Extension service, as well as support services for home industry entrepreneurs in general.

Again, both biological and economic diversification should be the goals of such an institution. Here on Earth, many universities and colleges do see enterprise support as a core function right alongside education and research. Indeed, such support efforts follow from research quite logically.

Even prior to the opening of a “university,” a Settlement Economic Development Office should foster such efforts. Given this favorable environment, it is likely that import of requested

MMM Theme Issues: The Lunar Economy - Years 1-25 Dec 1986 - Nov 2011

specialty seeds might be subsidized by the settlement government. The lunar settlement may start as a government – industry consortium. But human society will not truly be transplanted to the Moon or elsewhere until free spontaneous private enterprise on all scales becomes a coequal sector of the economy.

We have already seen [in the “Earthpatch” article last issue, and this month’s In Focus essay] that even if cottage industry products were not at stake, decentralizing biosphere maintenance is. By supplementing settlement farms and community parks with homestead gardens integrated with point

of origin primary waste treatment, we provide a much more flexible, varied, and buffered biosphere life support base. And that translates to security, morale, and long term viability.

Gardening & Food Processing Coops

Okay, you buy all this, but ...! How can a family garden in a small plot that can probably not be expanded, sustain any kind of economically viable food product operation? The scale is just too small.

We agree. In all but very special cases, this does not seem to be a viable way to proceed. But why assume that each family has to operate in isolation and self-sufficiently? On Earth, where family farming with much larger areas under cultivation has become economically untenable, giant corporate farming has made major inroads. But there is another option, and one that has been successful in many fields: dairy, livestock, as well as crop farming. We are talking about coops co-owned by farm families.

Let’s say you have identified a market for raspberries, not grown in the settlement farms. Other families could join you to raise raspberry bushes on staggered harvest cycles. Together you could market them as fresh produce and even down the road invest in processing operations outside homestead settings. The tested coop model may work on the Moon as well.

Now of course, this sort of coop-supported activity becomes more realistic as the population of the settlement rises. The amount of such endeavor is likely to grow exponentially as the population soars past a hundred to a thousand, ten thousand, and ... It is a commonplace that beginnings are very humble, and in retrospect, even invisible, unrecognizable, and untraceable. Still it is possible for just one family to break the ice and demonstrate the cottage industry path to adding new items to the diet.

It could well be that the settlement fathers will stick to their plan in producing only absolutely necessary basics in the communal farms, turning a deaf ear to those clamoring for coffee, tea, chocolate, wine, beers and other semi-addictive nonessentials. It may be left up to garden coops to take the plunge in such areas, and they will find a supportive market, no matter how inferior their initial products.

Once the first homestead garden coop appears others will quickly follow. New fruits, vegetables, herbs and spices will become available in Gardeners’ Markets. Premium lines of canned goods and new processed food items like fruit and vegetable juice cocktails will follow. Coops could produce partially processed recipe makers such as gravies and sauces, soups, condiments. They could also market compost, seeds and shoots, house plants and much more. Thus diversifying the menu and supporting more interesting cuisines for family home cooking as well as for restaurateurs will be just the first area of home garden supported cottage industry.

As versatile food crops increase in number, a wide range of interesting eateries will appear. That can only help the Earth tourist trade and inter-settlement tourism as well. The tantalizing aromas and odors associated with these new restaurants will soon become taken for granted. Of course, the first of these eating establishments may well be coop-owned.

Coops will give birth to trade magazines (the “Mother Moon News” and the “Earthpatch Farmer”) and offer basic and advanced courses in home gardening. They could organize home garden shows and cook-off competitions such as an annual “Taste of Luna City” event. Coops

MMM Theme Issues: The Lunar Economy - Years 1-25 Dec 1986 - Nov 2011

could conduct fundraising tours of outstanding home gardens, even contract with tourist companies for some gardens to be on one of their regular tour extension circuits.

All such public exposure will surely work to increase the percentage of homestead gardeners engaged in "production." Enterprising individuals in other talent areas will be inspired to follow the cottage industry and coop trail. The excitement of helping build a new civilization will spill over to

other areas of the economy. Enthusiasm is contagious

The lesson here is that by bringing together different areas of expertise, by marshaling real economies of scale, and by joint processing and marketing, the coop can combine the seemingly insignificant energies and abilities of individual home gardeners into products and activities that will make a real improvement in the daily lives of most settlers. It will be an improvement that just may tip the scales for many of those weighing the merits of returning to Earth or committing to life on the Moon indefinitely. Perks will be crucially important in creating a population that considers itself truly at home on the Moon. Coop-produced perks can help immensely.

Enter the Realm of Plant Byproducts

Homestead Garden enterprises can be aimed at other than the food, seasonings, and beverage markets. Plants are the source of fiber, with which to make rope, fabric, and paper. They are the source of natural organic dye stuffs like henna and indigo and many others. They exude resins useful in various

ways and fragrances. Some plants produce substances of medical and pharmaceutical usefulness.

Gardeners could cultivate plant species as a source of any of the above, harvesting the plants for further processing in coop owned facilities. They might want some of the processed pulp, dyes, and other extracts to use for homestead produced arts and crafts and other uses. There is no one fast model.

Wood is not a likely product of homestead gardens. Hard wood suitable for carving into jewelry value items (on the Moon, wood would be that rare) is more likely to come from fruit trees grown in the settlement orchards – apple, cherry, pear, pecan and others. Some of that wood could support cottage artisans making small but valued keepsakes and high end cabinet hardware (knobs and pulls).

Pulp for home-crafted paper can come from the stems of many plants otherwise destined for the compost piles or biodigesters. Such papers can be turned into gifts or greeting cards by family artists. Some would be sold at the Gardeners' Markets for others to do likewise.

Temporary art (art du jour) materials both for children to use to develop their abilities of creative expression and for short term advertising needs can use dried leaves, beans and seeds, corn cobs, and other items from the farms. Additional "special" items from home gardens may carve a niche here.

Even byproducts that represent but a small fraction of the total garden plant biomass might prove worth pursuing given that the remainder can find some use as fodder, mulch, compost or simply raw material for the biodigesters producing tofu-like supplemental food products. Such biodigesters will even make cotton raising reasonable.

Servicing the Home Garden Market

In addition to activities engaged in by coops, a number of enterprises might pop up to serve the horticulture market. Some of these services may be developed by homestead gardeners themselves out of necessity. After all, anything one succeeds in doing well for oneself is worth marketing to others.

But those not engaged in horticulture directly may have also applicable expertise, gained from servicing utility systems, manufacturers, and other sectors of the economy. Where there is a need to be filled and a buck to be made by filling it, someone will surely rise to the

MMM Theme Issues: The Lunar Economy - Years 1-25 Dec 1986 - Nov 2011

occasion. In the settlement's early days, many of these needs may go unfilled, and gardeners will find less help. But as the settlement population grows ever larger, the more certain that any identified or perceived vacuums will be filled.

- Composting service & equipment
- Water handling systems: pumps, filters
- Installers of "water features"
- Fertilizers and nutrient suppliers
- Lighting systems
- Thermal management & climate control
- Automated systems
- Software programs
- Canning & pickling supplies: jars, lids, labels
- Packaging consultants
- Garden doctors and consultants
- Garden planners and "architects"
- Pollinators and pollination services
- Recipe makers
- Marketing consultants
- Networking clearing houses
- Restaurant suppliers

The Bottom Line for the Settlement

Lunar frontier pioneers will not enjoy the immense variety of domestic and imported products to which we are so accustomed here on Earth. The costs of transporting any goods or products, tools or parts not absolutely necessary up through Earth's gravity well will mean that the settlers will be largely left to their own ingenuity and creative enterprise if they want to supplement the spartan "issue" items regularly imported. This is true not just for food, but for apparel, furnishings, and entertainment and hobby items. In each of these areas, ingredients produced in home cottage industry gardens will play some role in the campaign to provide the variety that is the spice of life.

Widespread homestead vegetable gardening will create a decentralized Food Growing System to supplement the settlement's farming operations. This will promote the settlers ability to survive blight, plant disease, and crop failure emergencies.

In all these ways then – biological diversity, biosphere decentralization, point-source waste treatment, support of more diversified menus and special cuisines, art and craft materials, apparel choices, art du jour stuffs, even alternative nutrition supplements homestead gardens will be a major player in the transformation of our "intentions" to remain on the Moon indefinitely into genuine viability.

But it is the contribution of cottage industry that to us seems the most important consideration. From the outset, the lunar settlements will be hard pressed to reach the economic breakeven point that will turn them from tentative ventures into outposts of humanity that are truly "established." Garden-based cottage industry will play a significant role in diversifying the economy and inter-settlement trade.

The break-even point will be reached when the total value of items produced on the Moon for export sustainably exceeds the value of items that must still be imported both to maintain the settlement and fuel its continued growth. The struggle to reach that point will govern everything, underpin everything.

That strong all-transcending priority means that all "day jobs" will need to be either directly or indirectly supportive of production for export. In other words, we will need all able-bodied or able-handed personnel to be so involved. Vital "indirect" support will be provided by agriculture, utilities, and domestic market manufacturing products needed to sustain a growing local populace.

MMM Theme Issues: The Lunar Economy - Years 1-25 Dec 1986 - Nov 2011

This does not mean that there is no room for economic activity aimed at filling “nonessential” and discretionary needs of people in search of the good life and greater comfort. It is the fact that people do not live by bread alone, no matter how nutritious (both these terms used both literally and metaphorically), that will motivate some more talented and more enterprising pioneers to use their off-hours to produce things that will feed the need for taste, variety, and a richer life.

Once the settlement has established itself and seems to be a sustainably viable partner in a Greater Earth economic market, we will see these off hour economic activities emerge into the mainstream. People will engage in meeting these good life needs of their fellow settlers on a full time basis. The domestic market will emerge as the primary market in the economy, with export/import activity assuming the supporting role. When that happens, the settlement will “have made it.”

Not by good food alone ...

The homestead garden is but one of several cottage industry enablers. We plan to talk about other likely fountainheads of cottage industry in future articles. As these humble beginnings begin to produce items that can be exported to help tilt the settlement’s economic equation, some of these humble “cottage” industries will evolve into main sector day job industries employing many new settlers. On the Moon, we’ll be behind the proverbial eightball. We’ll need to work every angle. <MMM>

Back Reading

MMM #2 FEB ‘87 “Moon Garden” [MMMC #1]

MMM #39 OCT ‘90 “Saving Money on Food in Space”
[republished in MMMC #9]

MMM #148 September, 2001 “Earthpatch”
[earlier in this file, MMMC #15]

“When ships to sail the void between the stars have been built, there will step forth men to sail these ships.”
Johannes Kepler (1571-1630)

MMM # 155 May 2002

“As long as we’re here...”: Secondary Profit Generators for Moon and Mars Bases

Bryce Walden, Cheryl Lynn York, Thomas L. Billings, and Robert D. McGown

Abstract – www.OregonL5.org/docs/sr2002d.pdf

Lunar and Mars base planners concentrate on one or two economic drivers to justify a base. This is like the “killer app” in the computer world, the single indispensable application that justifies the computer purchase. “Secondary profit generators,” numerous economic activities that make a complex lunar or Mars base work, have received less attention.

Trade with Earth is a special case. Due to Earth’s deep gravity well, transportation costs are far from reciprocal. Earth industry produces vital items unavailable elsewhere; however, Earth’s large population represents a huge market for off-world products.

Space commerce among bases on the Moon, Mars, and elsewhere in space brings opportunities in transportation, sales, legal services, and trade in minerals and volatiles, to name a few.

MMM Theme Issues: The Lunar Economy - Years 1-25 Dec 1986 - Nov 2011

As bases specialize, an “inter-base economy” will develop. Bases can specialize in power production or construction, for example. Precious volatiles could be traded, as long as they remain on-world.

Intra-base economy, or commerce within a single base, opens up a range of small business possibilities including repair shops, laundry, professional services, and others.

The more secondary profit generators a base can develop, the stronger and more resilient the base economy will be. Settlements initiated as “company towns” will transition to diversified economies.

Ultimately, the aggregate of secondary profit generators could dominate base balance sheets and do away with the need for a single economic driver to make a base a viable, going concern.

ORL5 LBRT (Oregon L5 Lunar Base Research Team)

MMM # 165 May 2003

In FOCUS:

Deep Pocket Heroes to the Rescue of the Space Frontier?

A few years ago, Robert Bigelow committed \$500 M of his wealth to pioneer tourist facilities in space. Last month, Burt Rutan unveiled his entry in the X-Prize “race.” Now we have Jim Bezos of Amazon.com starting up Blue Operations, LLC with a goal of launching a reusable space-craft carrying seven tourists to the edge of space, in the next few years. What’s up?

The suggestion that ultimately, it will take the wealth of one or more very generous, farsighted tycoons to really open the doors to space is many decades old, being the theme of more than a few science fiction yarns. While many still pin their hopes on NASA and government largess, a few have continued to hope that ultra wealthy individuals would be motivated by personal dreams, if not by profit, to “do the right thing,” and help create a breakthrough enterprise or two. Are recent announcements at long last vindicating such Quixotic forecasts?

The fact is that many of the schemes for busting wide open the gates to space would require many billions, or even trillions of dollars: solar power satellite networks; lunar solar power grid arrays & relays; a helium-3 economy. It would seem that only an international space agency or a tapping lunar resources for cheaper expansion of same; using those starter industries to build the first lunar power arrays for power beaming to Earth. One easy upgrade after another in a logical progression in which each phase pays for itself and generates seed money for the next. Each phase has reasonable near-term promise of Return On Investment. It would seem that Rutan and Bezos are buying into this game plan, as had Bigelow.

It is only natural that space enthusiasts from in the ranks of wage and salary owners, many of whom might imagine that “if only I had the money ... ” would wonder why those among the ultra “haves” who are known to be fascinated by space, space exploration, and visions of space development have not yet put their money where their heart is. But such expectations (and disappointments) rise out of a total misunderstanding of how money and wealth are generated. None of these wealthy enthusiasts got to where they are by committing major capital to undertakings that promised no realistic near-term Return on Investment. Capital is not for wasting on cathedrals or other monuments. It is for making more money.

Yes there is tax-deductible charity. But who in their right mind expects the Internal Revenue Service to see the commitments of hundreds of millions or even some billions of dollars to a space undertaking that might very well prove to be a dead end as a “charitable donation?”

So what has changed? Clearly two things:

MMM Theme Issues: The Lunar Economy - Years 1-25 Dec 1986 - Nov 2011

- The obvious whetting of the public appetite for tourist experiences beyond Earth's atmosphere
- The emergence of a clearly terraced master plan in which each phase pays its own way and leads to the next

The tourist pathway to space, even though only a few can now afford a ticket to the International Space Station, now has enough legitimacy and has attracted enough talented people to bring space tourism out of Blue Sky country into the realm of serious money-making opportunity. The X-Prize organization has helped generate abundant publicity, and helped somewhat to justify the gamble. What role it will have played in the successful opening of space is something left to future historians.

At any rate, these two latest "hats in the ring" are encouraging. One can hope that this will be but the start of a venture capital groundswell behind a workable scheme of terraced space development. Three Cheers !!! PK

Read more:

For the Jim Bezos story: <http://www.msnbc.com/news/904842.asp?cp1=1>

For more on the Burt Rutan story: www.airventure.org/2003/news/rutan_forum.html

MMM # 168 September 2003

"Working Vacations"

Ideal ways for Lunan Pioneers to get a Change of Pace and a Change of Scenery

By Peter Kokh

Not a New Idea

While not common, the idea of spending one's vacation pursuing another line of work, whether just for the change of pace and change of scenery, or to see if one likes the new "job" better than one's current dreary drudge is not new. I've done it more than once to make sure that I wasn't making a big mistake switching jobs. But here we are talking more about working during vacation just for the chance to enjoy new, perhaps even exotic experiences.

Indeed, here we are talking about being willing to pay for the privilege of indulging in the temporary job, when that is the only way to get a timely chance. We do not know who was the first to suggest a "working vacation" but these days one can sign up, and pay a registration fee, to go along on an archeological "dig" or man the sails and do other duties on a "Windjammer" cruise aboard an ancient sailing vessel. The organizers get more than free labor, paying labor! The eager-to-pay recruits get in exchange, an experience of a lifetime.

Archeological digs can be in prosaic Illinois, or in storied Mongolia. Either way, the work, to the temporary novice, seems exotic and engrossingly interesting. One typically works under a competent university staff capable of answering an endless flow of questions. Not quite Indiana Jones stuff perhaps, but close enough. Recruits willingly pay hundreds of dollars for the chance.

Think of it as tuition, a reasonable fee for a precious learning experience. How is it different from an apprentice paying to work under a master?

Fast Forward to the Moon! Consider these points:

- On any frontier, there is always more work to be done than people to do it, let alone the money to pay them.

MMM Theme Issues: The Lunar Economy - Years 1-25 Dec 1986 - Nov 2011

- Many endeavors can be pursued at a relaxed pace, when there is money and people available
- People need a vacation less to collapse into dormancy than to enjoy a change of pace, a change of scenery, an escape from everyday pressures and work-related problems and irritating persons

On the Moon, we do not currently expect that there will be any archeological expeditions – unless we stumble on a hoard of alien artifacts, carefully deposited for us (anyone) to find someday, in a lavatube where they could lie undisturbed by the cosmic elements for millions, even billions of years. But there are other worthy expeditions whose findings may someday improve the life and prospects of lunar settlers:

- **Prospecting** for unusual concentrations of strategic or rare elements
- **Exploring** Lavatubes
- **Building** roads or cableways into “new territory”
- **Erecting** radio telescopes in deep Farside, etc.

Working Volunteer Vacation Programs

A Google search will show that whether you want to dig for fossils or ruins or gold, or help restore a building that has fallen on hard times, or participate in building a timber-frame home or barn, or man the sails of a windjammer – if it means enough to you that you are willing to pay for the experience, you can do it!

Some Examples <http://www.crossculturalsolutions.org/>

Cross-Cultural Solutions is a not-for-profit inter-national volunteer organization that operates volunteer programs in Brazil, China, Costa Rica, Ghana, Guatemala, India, Peru, Russia, Tanzania, and Thailand.

The U.S. tax-deductible program fee for three-weeks is \$2,315 (£1,475), with each additional week of stay only \$220 (£140) per week. www.voluntarywork.org/go.htm
International Directory of Voluntary Work www.globalcitizens.org/whoweare.html

“The program cost of \$600–\$1,650 covers in-country travel and lodging, most meals, orientation materials, a share of the team leader's expenses (team leaders are not paid) and a donation to the village project. Airfare is additional. All trip-related expenses are tax-deductible in the U.S.

“Many people ask why they have to pay to volunteer. GCN receives no outside funding or grants and other than two part time staff people is completely volunteer driven. Also, while individuals may be able to travel for less to many of these places, GCN provides the entrance into a village and exposure to a culture that one could not receive if traveling solo to these places. Through the long-term partnerships that GCN has established with communities around the world, volunteers gain a unique perspective into life in a Guatemalan village or on the Navajo Reservation.”

www.wwooof.com.au

Working on an Organic Farm in Australia pays for your room and board while there.

www.parentspress.com/ffdinosaurdigs.html

Dino Digs, guided fossil-hunting for a fee

<http://charityguide.org/charity/vacation/archeology.htm>

Archeology Digs and Restoration Projects

www.robeks.com/Library/Document01.asp?PT=D&PID=68

A general article on the subject.

Lunar Working Vacations Spent Prospecting

Field work prospecting on the Moon will be tedious and monotonous work whether or not most of it is done from within the comfort and safety of a pressurized rover. For that reason, as well as in the interests of thoroughness, accuracy, and timeliness, most lunar

MMM Theme Issues: The Lunar Economy - Years 1-25 Dec 1986 - Nov 2011

prospecting will be done from orbit. But even with great improvements in resolution, orbital surveys risk missing the unusual find.

The surface regolith effectively samples the host crust. There is nothing within the upper kilometer or so of the crust that does not lie exposed on the surface in the debris blanket.

But what about deep mining? What about small nuggets of concentrated elements or minerals that are not widespread enough to show up from space? It is likely that there will be some surface prospecting, whether it is led by university staffs, treasure hunters, or clubs of prospecting enthusiasts. In all of these cases, paying for help will be a problem. But why do that if there is a supply of volunteers who would willingly pay for a 2 week experience?

The ultimate prize for prospectors would be the discovery of a Sudbury*-like "astrobleme" rich in iron, copper, nickel and other elements rare on the Moon, a gift of some impacting asteroid. (*Sudbury is in Ontario, 100 miles east of Sault Ste. Marie.) Such a find would soon lead to a new settlement and much industry. The economic viability of the Moon would receive quite a boost.

Another prize, for drill-prospecting would be the tapping of underground pockets of gases such as carbon monoxide. Such a reserve of carbon would be the lunar equivalent of an oil field, giving rise to a host of new organic chemical industries. Until we find the first such pocket, we can't be sure that any exist. The find of just one would touch off a flurry of additional drilling ventures.

Lunar Working Vacations Spent Exploring Lavatubes

Again, almost all lunar surface exploration will be more thoroughly, accurately, and quickly done from orbit. But we believe that there is much to explore below the surface, the lunar lavatubes, and possible remote instrumentation is not likely to do more than identify promising areas for on site exploration. The various maria may be laced with these subsurface features, possibly multiple layers of them. Work galore for many generations of volunteer explorers to come. Lavatubes a hundred meters across and many kilometers long are thought to be garden variety.

Some of these ventures will be organized by Luna University Geology Department staff. Other expeditions will be put together by clubs of "tubing" enthusiasts who hope to pay for their own equipment and expenses as well of those of volunteers with the fees paid by volunteers to participate. It will be exciting and promises to be significant. Lavatube networks may someday host industrial parks, warehousing and archiving complexes, lunar agriculture, and spacious lunar settlements.

Lunar Working Vacations Spent in Construction

You may work in the lunar farms, or in materials processing operations, or in a hospital or school, or have a job concerned with exports and imports. Whatever, when it gets to vacation time, you may welcome a chance to roll up your sleeves and spend a few weeks in construction work, "helping to build the Moon."

There will be plenty of teams to join as a paying volunteer. There will be construction of additional housing, of commercial and agricultural facilities, spaceport expansion, highways and cableways. You might even get in on construction of a major Farside radio telescope array.

Lunar Working Vacations Spent Establishing New Outposts

One town does not establish a lunar civilization. A real lunar domestic economy will require some variety of towns, each with their own advantages of location, be they scenic, mineralogical-industrial, logistical or other.

Any number of secondary outposts will also be established. Over time, the vast empty regions "in between" will be filled in. It could be just the shot in the arm you need to spend your vacation helping establish a new outpost in some remote region. And it would not be surprising if you or some of your fellow volunteer pioneers after returning to your regular day job, put in for a permanent transfer to the new outpost.

MMM Theme Issues: The Lunar Economy - Years 1-25 Dec 1986 - Nov 2011

For Tourists from Earth: Working Cruises

The working vacation is a paradigm that bears consideration in a much earlier era. It is quite possible that before the first human returns to the Lunar surface, tourists will skim above its surface in loop-the-Moon tours, never landing, but getting the visual experience of a life-time. Perhaps there will be two classes of passengers. Those who are just along for the ride and experience will pay (a) full(er) fare. Those willing to crew the tourist ship itself, becoming cooks, stewards, entertainment organizers, etc. will get a discount (to be made up for by the "fuller" fares of plain passenger-tourists.)

Once a permanent outpost is established on the Moon, costs of expansion can be kept down if interested capable persons pay to belong to the crews involved. After all, the demand to be on the great adventure will be great. Demand creates supply – there will be little need to "hire" pioneers at any level, even the most demanding.

If people pay or partially defray the cost of their own passage and maintenance, then mission costs become largely those of equipment. Yes, it is naive to think that all personnel costs can be reversed in this way. But it is a paradigm worth pursuing and pushing as far as it will go.

If the lunar, Martian, and space frontier in general are anything like frontiers of the past, much of the "front wave" in every aspect of this grand venture can be managed by paying volunteers on work vacations. It wouldn't be the first time.

MMM

MMM # 174 April 2004

Modular Container Factories

MODULAR CONTAINER FACTORIES

to Industrialize Early Lunar Settlements

By Peter Kokh

[Thanks to Bryce Walden, Oregon L5 for the heads-up lead]

A fairly new project in aimed at Third World Development offers a model for systematic and relatively painless industrialization of early lunar settlements: mini-production plants in mobile containers, transportable anywhere, and ready to go once hooked up to the necessary utilities. This makes time consuming construction of production plants on location unnecessary, along with the inevitable delays in getting all the needed parts, and shaking down the system operations. It also obviates the expense of time-consuming custom plant design. Most importantly, it saves labor time from plant construction and speeds up availability of product production both for the local (lunar settlement) market and for income-earning export, in the case of products in demand at other in space locations (low Earth orbit, Mars-bound freighters, etc.)

The plants use tested fully debugged designs, can be test-operated before shipment, and are modular. If you need to double production, you just gang another module alongside or in series. And they are sized just right for adaptation for shipment to the Moon and other space locations: 40 feet (13 meters) in length, and on wheels – just right for a shuttle-sized payload bay or cargo hold. Worldwide Partners SN World Foundation is the outfit responsible – www.world-foundation.org.

We'd want to do some brainstorming to get our priorities right in designing the plants needed first, i.e which are prerequisites for others. But the whole container plant idea seems

MMM Theme Issues: The Lunar Economy - Years 1-25 Dec 1986 - Nov 2011

quite versatile given the list of those already being manufactured for Third World use. There are an amazing 700 different portable units currently in use.

Just a few of the many varied container factories give an idea of the great versatility of this system:

Biosphere & Prepared Foods – Water purification
Bakeries – Dehydrated food – Fruit juice preparation
Construction Materials – Aluminum Buckets
Reinforcement Bar Bending for Construction Framework
Steel Nails – Sheeting for Roofing – Ceilings and Façades
Construction Electrically Welded Mesh – Plated Drums
Synthetics – Injected Polypropylene Housewares
Pressed Melamine Items (Glasses, Cups, Plates, Mugs, etc.)
Plastic Bags and Packaging
Vehicular Equipment – Tire Retreading – Mufflers
Medical & Health Equipment
Medical assistance mobile units – Sanitary Material
Hypodermic Syringes – Hemostatic Clamps, etc.

Adapting the Container Plant Concept for the Lunar Frontier

What seems especially appropriate about these mobile modular container factories are these two features:

- a uniform compact size, one that would fit in a shuttle orbiter payload bay or could ride to space in a faring atop many of today's expendable launch vehicles.
- that you need only plug it into the needed utilities, feed in the needed raw materials, and start producing

Lunar Industrial Parks Made for Container Factories

That the plant comes in a container is logical, as the walls are attachment points and support for equipment. For lunar adaptation, you could provide a pressurizable container, but on reflection there seems a better idea: use the containers as they come, but place them in a host pressurized industrial park volume, outfitted with utilities and stalls and aisles for service vehicles, supply of materials and removal of products. If we take this approach, some of these mobile container factories might be usable on the Moon as they are. After all, it is clearly inefficient to duplicate systems that can easily be shared.

Situating these container factories within such a host complex offers additional advantages:

- Container Factories requiring the same raw materials can be clustered together
- Clusters could also be based on similar by-products that need to be stored separately for recycling / reuse
- Clusters could be based on a thermal cascade with the plants running at the highest temperatures at one end, the coolest at the other, so that waste heat from one can be used in the next.

The host "industrial parks" could be modular in themselves. As the settlements diversify their industrial capacities, there will be need for more such parks.

Shielding these sizable and expandable industrial parks could be a challenge. If the settlement was placed with foresight near an intact lavatube, that would be ideal. Such a volume could easily house inflatable and other "less-fortified" structures safely, as well as the supply infrastructure needed to keep everything running, plus, and this is a big plus, all the sheltered warehouse space for products waiting shipment to market, whether that be for domestic settlement use or somewhere off the Moon.

MMM Theme Issues: The Lunar Economy - Years 1-25 Dec 1986 - Nov 2011

A supporting consideration is that lavatubes are most frequent near mare/highland coasts where both the most common suites of lunar materials are readily found. Locating a settlement at one of the poles would almost certainly squelch any chances for industrialization and thus for export-import break-even, the key to permanence.

What Container Factories should come first?

There are several guidelines here in developing a plan for quick and timely industrialization of the lunar settlements – and timely is the operative word. Until the frontier economy reaches a point where the pioneers can earn enough from exports to Earth (other than energy products and souvenirs, not much) and to other “in-space” markets (low Earth orbit space stations, industrial parks, and tourist clusters – and the early Mars frontier) to pay for the importation of those essential goods and materials that they cannot yet produce for themselves, the lunar settlements will remain “tentative” and vulnerable to the vagaries of economics and politics on Earth. The longer that “permanent human presence” remains subject to such outside irrationalities, the more likely it is that something will develop to force an end to the dream.

The guiding considerations would seem to be these, and they do not neatly coincide:

- those products needed for domestic lunar use in the largest per capita total mass, will be most helpful in reducing the cost burden of importing them.
- some products / capacities are prerequisites for the production development of other products / capacities
- products that help build habitat space and utility infrastructure should have priority over those that supply only creature comfort.
- tools production is more important than product
- arts & crafts tools and materials are essential for overall morale because of their capacity to generate a feeling of being “at home” on this challenging world.

The lunar industries dependent on the pulverized regolith surface blanket for raw material that seem easiest to jump start are sintered powdered iron products and cast basalt production parts some of which will find immediate service in materials handling systems. Earliest possible oxygen production is also essential. Beneficiation systems that produce “regolith extracts” enriched in various needed elements will have to be right up there. Surely, glass-glass composites industries requiring less refined raw materials will be an early mainstay. Beyond that, the paths of industrial diversification merit big time ongoing brainstorming by diverse teams of experts.

Humans do not live by Processing & Manufacturing alone

We can also make immediate use of Container Water Recycling & Purification “factories.” And to supplement early garden to mouth menus, container factories that produce bread and other basic prepared menu and recipe products will be in demand as soon as the number of people in the settlement is large enough to benefit.

Early domestic products will include glass, glass composite, cast basalt and ceramic tableware and furniture items to furnish new homesteads and make them livable. And this is not a trivial goal. Everything that can be used domestically, can probably be exported at a profit and at a competitive cost advantage to space markets such as LEO and elsewhere, especially if it is well and tastefully designed..

Other early products will be spare parts for vehicles and equipment in common use – certainly those parts that are not complex or sophisticated and do not have critical tolerances – dust fenders, to give one example.

Container Factories and Manpower Needs

While for their original purpose, industrializing Third World communities, automation would certainly be a low priority, for use on the lunar frontier, the opposite is true. On all frontiers in human experience, there has always been more work to do than people available to

MMM Theme Issues: The Lunar Economy - Years 1-25 Dec 1986 - Nov 2011

do it. Any of this container operations that can be automated will free pioneers to work that cannot be so easily disposed of.

Container Factories and Energy Needs

Some operations – cast basalt products, glass and glass composite products, ceramic products, and metal alloy production – require a lot of heat. Heat can efficiently be produced in dayspan by using solar concentrators. All operations will require some electricity, and the amount will vary greatly. Operations that are highly energy-intensive may have to be reserved for dayspan when more total energy is available whether the settlement has a nuclear plant or not. Those operations that have a labor-intensive element that can be conveniently separated out, can run in dual mode throughout the sunth, energy-intensive tasks done during dayspan, labor-intensive ones, such as routine maintenance, changeouts, packaging, inventory, etc. can be done during nightspan. Of course, not all operations will lend themselves so neatly to such an alteration of tasks.

Container Factories and Water Usage

If the settlement is located where the greatest percentage, tonnage-wise, of needed materials can easily be sourced, it will be along a mare-highland coast. Water can be produced by solar wind gas scavenging performed religiously as a part of all regolith handling operations: road construction, site grading and preparation, gathering material for processing plants, transforming regolith into soil for those crops that do better with soil buffering, etc. The regolith would be heated and the gas, mostly hydrogen but appreciable amounts of carbon, nitrogen, helium, neon and argon would be collected and separated. This operation is called “:primage” and it sets the settlement up with resources it would not otherwise have.

If the settlement was placed as close as possible to the nearest polar permashade areas (craters over 20 km in diameter as far as 30° from the pole will do, such as the north coast of Mare Frigoris, it will be situated well for earliest possible start of those operations that there is no other way to do than with intensive water usage.

Summing up

It is clear that the Container Factory concept brightens the prospects for lunar settlements. We need to study this existing model, factory by factory, for adaptability to a variety of lunar settlement conditions.

MMM

MMM # 181 December 2004

Human-Robot Synergies

By Peter Kokh

When there are so many things we can do together, that neither humans nor robots can do by themselves. the “Humans versus Robots” debate is worse than useless. It’s a waste of precious time and a mischievous diversion.

Not letting the “other side” control the discussion

Most of us get more than a little riled up when a planetary scientist, interested only in science data, gets on a soapbox to condemn the manned space program. Yes, they are shortsighted: in the long run, if not in the short term, we will learn much more about the solar system if humans are involved at the forefront of exploration, and, even more so if explorers are followed by settler pioneers. Compare what we now know about the geology, flora, fauna,

MMM Theme Issues: The Lunar Economy - Years 1-25 Dec 1986 - Nov 2011

and other aspects of the Americas with what we would know if Europe had had robot probes back then, and had only sent those.

The knowledge that robots return from their planetary missions is indeed priceless – compared with no knowledge at all. But if we indulge in the “versus” argument we are letting our myopic friends control the debate.

Human Tool Partnerships are Primeval

We became humans while using tools. The tool is the extension of the hand. It can do things that fingers and fingernails cannot. But the tool without the human to use it is an admirable piece of art and no more. This partnership has taken on new meaning with the appearance of each new and improved tool. Nor is the idea of tools going where hands dare not something new. Consider the tongs that holds red hot iron over the anvil, or molten glass in the furnace. They take us places where we could not go without them. The canoe, the boat, the car, the plane – and the camel and horse before them, serve as aids. How often has not each of us felt them to be an extension of ourselves.

Humans vs. Robots in Space

Thus the idea of human-robot partnerships is hardly revolutionary, though to hear some speak, you might get that idea. Perhaps it arises because in space applications, robots are not things we wear, physically wield, or ride, but have become proxy scouts, going far beyond borders that we are not ourselves prepared to pass. But the pendulum must inevitably swing back. Thesis begets antithesis and ultimately synthesis. The synthesis of the human and robot space explorer is where we are headed.

Early robotic probes simply reported back to us. But gradually, we have found ways to give them instructions, even new instructions, changing their programming. We’ve had far more luck along this line with orbiting probes and probes coasting through space where time was not of the essence. But the radio link hardly re-establishes a hand and glove, hand and tool relationship. We’ve been able to do that clumsily for some time, with surface probes on the Moon where the time delay of under three seconds is something we can learn to master. I said “able” because we haven’t had a surface probe on the Moon to teleoperate. On Mars we do, and Sojourner, Spirit, and Opportunity have amazed us with the data they have returned. But the amount of “work” each of these rover-probes is able to do in a day is much less than one percent as much as would be possible if the teleoperator was stationed on Phobos or Deimos a few thousand miles away, instead of on Earth, between 35 million and over 200 million miles away, suffering with time lags of 6–40 minutes instead of a fraction of a second.

Indeed, there is a strong argument for sending robots to prepare a site for human arrival, doing things well beyond return flight fuel production. They could grade sites, excavate hollows, pile up shielding berms, even make a supply of building blocks or sand bags. They could drill into the soil to tap the permafrost, possibly even tap liquid water aquifers deep below the permafrost layer. They could explore nearby lavatubes, mapping them, determining points of accessibility. They could construct a landing pad, and a road network. One could go on and on. But only if all this activity were teleoperated from a convenient perch on Phobos and/or Deimos.

Symbiosis Regained.

While such prospects are interesting, we are totally missing the boat if we only see robots as remote agents to be teleoperated. Once both humans and robots are on the scene together, we will quickly reestablish the prehistoric role of the hand and tool, the rider and horse, the driver in his/her dream car – the paradigm of the extension of one’s own being and capacities.

Humans and Robots will work together, each doing what they do best. In the Canadian High Arctic, on Devon Island, both at the Houghton Mars (NASA) outpost and at the Mars Society’s Flashline Mars Arctic Research Station, crews on simulated EVA excursions have learned how helpful companion robots can be. Little tethered scramblers can go ahead, climb down and back out of crevices and gullies, scamper up cliffs and escarpments to take a look,

MMM Theme Issues: The Lunar Economy - Years 1-25 Dec 1986 - Nov 2011

even crawl under rovers to check for damage to the undercarriage from passing over boulders. Similar experiments have been underway with one NASA crew each season at the Mars Desert Research Station in Utah.

The Robot as an Idiot Savant Scout

The robot scout can be equipped with visual apparatus far more sensitive than the human eye, with a chemical sense of smell far more acute than that of a bloodhound, with texture discriminating senses far more attuned than the human finger, the elephant's proboscis, the octopus' tentacle. Imagine how helpful that would be to the prospector looking for valuable trace elements in unusual concentrations, to geologists and exobiologists looking for clues. Like any Idiot Savant, the robot will have no appreciation for what it has found, following its detection programming. But it will isolate and identify rocks and samples the accompanying human will want to inspect further, making the prospector or scientist far more productive on each sortie, wasting far less time looking at non-significant samples. To put it colorfully, the explorer with a robot companion will have to kiss a lot fewer toads to find the handsome prince. A prize sample found and presented to its master, the robot companion might be even more helpful by holding the sample so that the human master can work on it with both hands free.

Companion robots of this kind can work at the end of a physical tether, or at the end of an electronic one, so long as line-of-sight with its handler is maintained, either directly, or by it placing mini-relays at strategic points. Signals from the robot companion could be translated into audible intelligible form. Visual data could be flashed on a heads-up area on the visor of the human handler. Other data could appear on some sort of conveniently placed screen in various readout forms.

Robot companions will also go where their human handlers cannot, into hot nuclear piles, for example, into impassable rubble strewn lavatube entrances, spending hours, even days, in the hot lunar sunshine. But just as there will be close companion robots, and remote robots, so also will there be even closer associations.

Back to the horse, the canoe, the car

We don't think of any of the above as robots, but actually they are the antecedents of a class of robots where the human-robot synergy will be especially intimate and intensive: robots we wear, robots we ride. Most pioneers will seldom be out on the lunar or Martian surface - both are extreme environments. Prospectors, rock-hound hobbyists, spelunker lavatube explorers, and crater peak climbers are among those who will frequent the out-vac, enjoy being washed by the cosmic elements. But their activities will be both more enjoyable and more productive if they wear or ride their robots. Far from being science fiction, we've been at this point without realizing it for some time. Nor are we talking about the recent cybernetic revolution that has put computer chips in everything from toasters, to washing machines, to automobile transmissions, and sewing machines. Think of the operator of a construction crane, or of an open pit mine steam shovel, or of an icebreaker, or of yourself on a garden or farm tractor, or the wheel of your car. These machines all extend our capacities, doing things we could not do with hand tools, even with hand-held power tools - and we wear them.

The buppet or body puppet or robosuit

Someday, lunar prospectors and scientists may go out into "the field" inside one person pressure capsules. They might have a variety of deployable transit modes from wheels, to tank-like tracks, to long jointed legs that can scamper up boulder strewn crater rims, or even bound over rille valleys. They will have appendages you operate safely from inside, appendages with interchangeable tools and finger like sensory probes. Inside your wearable robot, you will be warm when it's bitter cold outside, cool when it's scorching, protected from the glare ... and listening to the surround sound recording of your choice, the refrigerator close at hand. The buppet or bodybot and you will be more than a team. As you get familiar with it, and it gets familiar with your touch, you will bond, becoming one. And as a team you will get far more done than either could do alone or in mere sequence.

MMM Theme Issues: The Lunar Economy - Years 1-25 Dec 1986 - Nov 2011

Productivity and Conservation of Human Labor

No experiment is a failure if we learn from it. But to the extent that Biosphere II seems on first superficial glance to have been a failure, one contributor was the prior decision to have the human biospherian volunteers raise all their own food, by primitive hand gardening means. On the space frontier, given the cost of transporting humans to and far away shores and supporting them with whatever they cannot (yet) provide on location, it will be especially important to use manpower wisely. Growing food, to the extent that automation, semi-intelligent robots (idiot savants) and teleoperated equipment can do the same job better with far less human man hours is surely one place where human-robot synergies must be applied to the utmost. We have already seen how companion robots can greatly multiply the productivity of prospectors and scientists in the field. Human-robot teams will do the mining and mineral extraction, the manufacturing, the construction of new habitat space, new factories, new schools, new agricultural units. HR teams will build new roads, explore and develop lavatube shelter spaces. They will deploy astronomical installations, giant solar power arrays, maintain nuclear power facilities, maintain the biosphere recycling systems. In short, the idea of humans or robots working alone in many areas of activity will become unthinkable.

The point of all this is that the future frontier of human-robot synergies are not a brave new world, a world that would be unrecognizable to our grandparents, or even to our preindustrial age ancestors. Development of human robot synergies and teamwork and strategies and modes of interaction and integration – all this is but the logical extension of the quintessential human relationship with tools. Indeed, there is growing evidence that this relationship may have been pioneered by protohumans, as we see more and more evidence of discriminatory tool use in Chimpanzees and other not-so distant relatives.

Working hand in glove with robots is indeed the way we will continue to explore “being all that we can be,” because we cannot be as much as we can be without them. We must work to change the discussion from “humans vs. robots” to a more productive “humans **and** robots.”

MMM

MMM # 188 September 2005

Zero-Mass Products & Services as a Major Part of a Lunar Frontier Economy

By Peter Kokh

At the Planetary & Terrestrial Mining Sciences Symposium in Sudbury, Ontario last June, we had the pleasure of meeting Klaus P. Heiss. Our initial misgivings based on his well-known support (on highfrontier.org) of Star Wars Space Defense initiatives, quickly gave way to respect and admiration for his clear brilliance and command of the issues involved in opening up the Moon.

Klaus correctly points out that the Lunar Settlements will not pay their bills (for imports) with material exports to Earth's surface. First, most anything that can be made on the Moon can be made here on Earth – with the rule-proving exception of Helium-3. Transportation costs will make “competing” lunar products anything but competitive, let alone an add on for amortizing the capital equipment needed for their manufacture on the Moon. The frontier will need to concentrate on “Zero-G” massless products. Among these he lists the following:

- Information: 40%+ of modern economies are based on information flow, not product flow.
- Communications
 1. C-Band, Ku-Band, LEO-HEO-GEO
 2. GPS, Navigation

MMM Theme Issues: The Lunar Economy - Years 1-25 Dec 1986 - Nov 2011

- Observations
 1. Earth Resources, Environment, Weather, Climate
 2. Solar System, Milky Way, Galaxy
- Energy: Enabling Resource
 1. Solar: Lunar Solar Power Arrays, Solar Power Satellites constructed of lunar materials
 2. Nuclear: Fission, Fusion, He3

Non-terrestrial markets for lunar physical products

While the importance of massless products as a mainstay of the lunar economy is not disputed, Klaus (and others) overlook(s) the possibility that the main market for physical products made-on-the-Moon will be not current consumers on Earth's surface but those in other off planet markets that will arise during the same time frame as lunar settlements: In low Earth orbit space stations, orbiting manufacturing facilities and laboratories, in orbital tourist facilities and hotels; even the outfitting of space craft meant to ply the space lanes without ever landing on Earth; markets on Mars and its Moons, and out in the asteroids.

For these markets, anything the lunar settlements are able to produce for their own domestic consumption in place of expensive imports from Earth, can be competitively marketed to other concentrations of people in space at a transportation-cost advantage over similar products made on Earth's surface. Building materials, furniture, utility systems, even food products may come under this heading. We simply cannot and must not forget that the lunar settlements will not develop in a vacuum!

Additional Categories of Zero-Mass products & Services

In addition to those listed by Klaus, we feel the following product & service sectors will play a major role in the buildup of the lunar economy.

- Virtual Tourism: Teleoperable rovers can provide back-grounds for movies, electronic games, racing, and plain tele-exploring. The user on Earth will pay for the use of the equipment on the Moon to pursue his/her interests and curiosities. There will be major advances in Virtual Reality technologies to support this.
- Virtual Employment: Persons on Earth will take care of the many paperwork and bureaucratic tasks for lunar settlements, including tech support, analysis, and even teaching, freeing pioneers on the Moon for those duties that cannot be tele-outsourced and which more directly support the production of products for export.
- Real Tourism: the first lunar tourists will simply swing around the Moon without landing. This will be followed by self-contained landing excursions. Next will come landers visiting modest surface facilities, supporting short overland excursions. As settlements arise, income from tourists from Earth will rise significantly, as costs fall.
- Archiving: Lunar lavatubes, those intact have been intact for 3.8 billion years, are the most ideal locations in our solar system for archiving anything we want to outlast our own current civilization. The cost of archiving records and historical artifacts, genetic materials, samples of flora and fauna from around the world, paleontological fossils, and other "Ark" services, etc. will be worth it as there is no comparable alternative. The lavatubes provide vacuum, controlled low temperatures, dust-free environment, virtually no maintenance costs. Placement could be done robotically or tele-robotically, as could retrieval. In addition to public records, personal memories and memorabilia and time capsules could be so preserved for billions of years to come.
- Technology Licenses: Lunar settlements will develop biospheric know-how and methods because they have to. This know how will not be developed on Earth because we are not "under a similar gun." But once created, this know how along with other technologies developed on the Moon, will be a zero-G export category of significance. Lunans will develop new materials (e.g. glass composites), new alloys (making do with alloy ingredients available on the Moon - along paths unexplored on Earth), new production methods, etc. - all because they must: many materials used on Earth

MMM Theme Issues: The Lunar Economy - Years 1-25 Dec 1986 - Nov 2011

cannot be produced on the Moon, and methods used on Earth cannot be used on the Moon.

In short, those who can see no economic future for lunar settlements exhibit a major lack of imagination. The opportunities for making money on the Moon are abundant, and I am sure that those listed above will be proven to have just scratched the surface.

<MMM>

"When you are inspired by some great purpose, some extraordinary project, all your thoughts break their bounds. Your mind transcends limitations, your consciousness expands in every direction, and you find yourself in a new, great and wonderful world. Dormant forces, faculties and talents come alive, and you discover yourself to be a greater person by far than you ever dreamt yourself to be."

– Maharishi Patanjali, India, c. 500 BC

Be concerned not with what others have failed to do.

That is beyond your power to change.

Be concerned rather with what you have failed or might fail to do.

Then the world will be all right.

MMM # 190 November 2005



CO-OPs as Enterprise Accelerators: Homestead Garden-based and other Cottage Industry Cooperatives will take Early Lunar Frontier Enterprise "Prime Time"

By Peter Kokh

The Early Frontier Situation:

How do we progress from an early frontier settlement in which all arrivals have been recruited for full time production work in mining, processing, manufacturing, and other essential industries aimed at maximizing exports and minimizing the need for imports? When, and how will the settlement reach that stage where the first self-employed pioneers can successfully launch their own businesses? How do we get from a company town, hopefully a multi-company town, to what looks like a normal civilian settlement with a truly diversified economy?

The situation in the early frontier will be that every able person has a regular "day job" as an employee. Will some just "quit their day jobs" and set out on their own to make a living serving the pioneer consumer market? That is possible, but daring without a heap of capital and a hefty savings cushion. A far more likely "fail-safe" route is that talented and motivated pioneers will take the first steps in their free time, after/before work and on weekends, in their own homes, not quitting their day jobs "just yet."

Built-in Launchpads for Cottage Industry Enterprises

MMM Theme Issues: The Lunar Economy - Years 1-25 Dec 1986 - Nov 2011

If the launching and development of private enterprises is something to be desired, the settlement Fathers could guarantee a favorable climate by “engineering into” the settlement system and both its legal and physical infrastructure a number of critical built-in features that would encourage and nourish “Cottage Industry” activities of many types, creating a favorable climate. Our pick of these built-in features follows.

a) Enterprise Seeds: Overtime Exemptions

Company employees wanting to attempt launching a cottage industry activity would apply for a limited time exemption from any mandatory overtime requirements: say six months. Near the end of this term, if the entrepreneurial activity had not been abandoned and was showing promise, an extension could be requested and granted. A non-company review board would hear the request and approvals would be binding on the applicant's employer. Without some protection of an employees “free time,” the entrepreneurial climate would be severely handicapped.

b) Enterprise Seeds: “Greathome” Spare Spaces

Most of us might expect pioneer homes to be small and cramped, a carryover from space station and early outpost sardine can living. Back in MMM #75, May '94, we introduced the “Great Home” concept.

Size of Lunar Homes – the “Great Home” Concept

We must resolutely and brazenly set aside the notion that lunar settlers shall be forever condemned to endure life in cramped quarters. As long as pre-built shelter must be brought in from Earth, weight limits will work to keep pressurized space at a high premium.

But once simply and cheaply and easily manufactured housing modules have been designed that incorporate local lunar materials almost exclusively, valid reasons for pioneers to continue accepting constrictive personal quarters evaporate.

If it can be achieved within the labor and productivity budgets of the settlement, there is no reason why lunar settlers should not request and receive homes that are spacious by American standards. Indeed, there are good reasons to err in the opposite direction. First, considering that lunar shelter must be overburdened with 2–4 meters of radiation-absorbing soil, and that vacuum surrounds the home, expansion at a later date will be considerably more expensive and difficult than routine expansion of terrestrial homes. Better to start with “all the house a family might ever need”, and grow into it slowly, than to start with initial needs and then add on repeatedly.

Extra rooms can, of course, be blocked off so as not to be a dark empty presence. But they can also be rented out to individuals and others not yet ready for their own home, or waiting for one to be built.

Even more sensible is the suggestion that the extra space will come in handy for cottage industry in its early stages, before the new enterprise is established, matured, and doing enough business to be moved into quarters of its own. At the outset, with every available hand employed in export production, the demand for consumer goods, furnishings, occasional wear, arts and crafts, etc. will have to be met in after-hours spare time at-home “cottage industry”. The lunar “Great Home” could meet this need elegantly

c) Enterprise Seeds: Homestead Gardens

The Moon, outside the airlock, will always be a harsh, hostile, unforgiving environment. More to the point, it will always be barren of life as we are used to seeing it outdoors. We have to bring the green lawns and gardens inside, if we are to have them and enjoy them at all. Those of us who enjoy living in detached single family homes enjoy outdoor greenspaces as an integral part of our property. On the Moon, such a welcome benefit must be provided indoors with built in garden space. We've talked about this many times, most recently in the article “Earthpatch” in MMM #148, Sep. '01. We followed up in the next issue, #149, Oct. '01, p. 5, “Homestead Gardens & Early Cottage Industry.”

Many Hurdles Facing Cottage Industries

MMM Theme Issues: The Lunar Economy - Years 1-25 Dec 1986 - Nov 2011

To develop a home-based enterprise, one must find affordable sources for tools, equipment, and needed raw materials: seeds, seedlings, fertilizer for the gardener; clay for the potterer, etc. One must find appropriate packaging and labeling materials, and most importantly, markets. This all takes time and effort difficult to spare from the daily attention demands of the cottage industry activity itself. It becomes instantly clear that with out a supporting network of related industries, starting an enterprise becomes a losing proposition. Enter the co-op.

Co-ops Combine the Forces of Many Spare-timers

If our would-be home garden entrepreneur forms a cooperative association with others attempting to do the same thing, they can then combine purchasing power, and marketing resources. Taking our Home Garden example, the co-op can find seed and seedling sources, tools, fertilizers, pest control, and other business needs such as pots and other containers, labels, etc. Members can share advice and experience and tricks of the trade. Legal advice and insurance is another area best handled on a shared basis.

A Home Garden Co-op can find space to market the products of the individual members. Manning market outlets would be shared, with all members contributing a few hours. Coop markets could start as weekend enterprises, and expand hours as success and demand warrant. In this fashion, a number of spare-time entrepreneurs can launch a whole cottage industry sector even in a young settlement, without anyone involved on a full-time basis. With time-share management, minding the store and other duties become onerous to no one.

The Co-op can encourage friendly rivalry: development of improved and diversified products, more convenient packaging, and expansion of the consumer market.

In finding and developing a network of suppliers, the co-op encourages the rise of complementary industries. It all knits together. Support industries will include:

- Containers
- Labels
- Canning supplies
- Dehydration
- And more

Through home garden co-ops, pioneer consumers will find many new products:

- Canned & foods: jams, jellies, soups & sauces, condiments
- Seeds, seedlings
- Cut flowers
- Composting services
- Fertilizers, mulch
- Dyestuffs
- Floral arrangements
- Craft papers
- Paper craft items
- Wood items
- Carved wood jewelry
- Medicinals
- Herbs & spices
- Recipes, cookbooks
- Cooking demonstrations

Online co-op markets are another way individual gardeners can work together to develop more business. For the individual consumer, the co-op market will make finding what they want so much easier – “one-stop shopping.”

Streetside Garden Co-op markets could also host cafes and restaurants featuring their products and produce, as an unbeatable way to hook customers on their goods.

From Food to Fabrics: a Home Garment Industry Co-op

While it may be possible to grow cotton and other fiber producing plants in the home garden, the quantities needed render fiber production at home a most unlikely endeavor. However, using not the Earthpatch Garden space, but other spare space in the Great Home, individuals can get into the fabric and garment industry on a cottage industry basis. They can purchase bolts of fabric and/or standard issue garments for altering from the settlement farm mill, as a basis for a number of Cottage Garment Industries.

The settlement fabric mill, a subsidiary of the settlement agricultural farms, in addition to production of a basic selection of fabrics available in bolts, will likely produce a line of basic

MMM Theme Issues: The Lunar Economy - Years 1-25 Dec 1986 - Nov 2011

standard issue products: underwear, shirts, blouses, pants and slacks, etc. In the interests of efficient productivity, a minimum of variety will be offered. both in garment designs and in fabric bolt colors and patterns. And that leaves the door wide open to follow-on entrepreneurs.

In addition to creating custom garments of their own design from available bolts, individuals can purchase standard garments in quantity at a discount for alteration either on request or on speculation re-tailoring them, dying them, adding appliqués and adornments, etc. A Co-op for home fashion creators would help improve output, profit, and variety. The co-op could purchase equipment and supplies at a discount for the benefit of its members. It could run Co-op consignment fashion outlets, both physical and online. Again, friendly rivalry would work to create more variety and better quality all for the consumer's benefit.

A Home garment industry co-op could run a fabric and garment dying operation much more efficiently, as it would do so on a full time basis, using equipment and raw materials more efficiently. A sewing machine repair person would be a complementary addition.

fabric and garment dyeing might well be one of a number of "controlled activities" because of the load it may place on the settlement water-recycling system. A co-op facility would be able to pretreat the effluent dye-containing drain water before dispensing it into the settlement's drainage network.

The Co-o's dying facility would purchase equipment sufficient to meet member demand, and work with members to schedule facility usage. It might also keep some equipment free for usage by individuals who need such services rarely and are not co-op members.

A Home Garden Co-op Consignment Outlet could, in addition to a variety of custom garments and apparel accessories, offer materials, equipment and patterns, for the fabric hobbyist wishing to make things for use around the home or as gifts, well short of plunging into a cottage industry business. Fabric and garment scraps would be for sale for turning into artifact creations from rag-rugs to rag-dolls and more.

A Woodworking Co-op

In general, it will be imperative for the settlement's success to recycle all biosphere-derived materials. All waste biomass will be recycled. Food, reprocessed by the digestive system will be further decomposed in the settlement sewage works back into water, carbon dioxide and soil amendments to reenter the biosphere food-growing cycle. Because wood incorporates rare hydrogen, carbon, and nitrogen, withdrawal of wood for use in construction, making of paper, and other uses for which substitutes can be found, will be discouraged by heavy "withdrawal" taxes.

This will make wood a precious item on a par with jewelry stuffs. In furniture, we are likely to see high end metal case goods (dressers, cabinets, etc.) sport wood handles – just he opposite of our common practice. Wood jewelry will be highly valued. And as it happens, common orchard fruit tree woods are hard, and make fine carving woods: apple, pear, and, of course, cherry.

So we are likely to see cottage industries based on premium wood use. A home-based wood adornment industry could benefit from a Co-op's purchasing power of equipment and supplies, as well as co-op maintained workshops out-fitted with extra-expensive seldom used or needed equipment. It could maintain a wood craft and wood jewelry consignment store, both streetside and online.

A Custom Home Furnishings Co-op

In the section above about Home Garment cottage industries, we mentioned our expectation that the settlement fabric mills would of necessity concentrate on a bare minimum of standard issue garments, leaving to entrepreneurs their further customization as well as the creation from scratch of a great variety of apparel items and accessories. We expect that the same will be true of the settlement furniture factories. "You will be able to buy whatever you want so long as it is the one model and color we produce." "Issue" furniture, however, will be designed to be post-manufacture customization friendly. And that opens the door wide for

MMM Theme Issues: The Lunar Economy - Years 1-25 Dec 1986 - Nov 2011

individual designers and craftsmen getting start on a cottage industry basis. Cf. MMM # 77 July '94, p 4. Inside Mare Manor Pt. II: "Cinderella Style"; Furniture.

Homemakers want to express their own individual personalities in the way they furnish their "digs." The appetite for variety and distinctiveness and uniqueness is extremely strong. Those with appropriate talent will be much in demand. A furniture/furnishings cottage industry co-op could, in addition to bulk purchasing power applied to equipment and materials, maintain co-op workshops for less frequently needed and specially expensive woodworking and finishing equipment, leaving the home woodworker to concentrate on equipment to be used more frequently, etc. The co-op could also maintain streetside and online co-op consignment markets, leaving the member entrepreneur to concentrate on production.

Custom tables, dressers, cabinets, bed headboards, lamps, etc. will be in demand. Again, rid yourself of the expectation that wood will be a common furniture material. Think instead of metal alloys, ceramics, glass composites, even concrete. All of these will require special tools to shape, finish, and adorn. Unlike the situation here on our still well-forested planet, the furniture maker will not be a graduate carpenter.

Co-op Scavenging Industries

As here on Earth, scavenged materials have the very attractive quality of being free for the price of disassembly and cleanup. For craftsmen and other enterprising individuals operating, or beginning operations on a shoestring budget, scavenged items and materials present an attractive situation.

Such unwanted materials include not just consumer trash items, but also post-manufacturing seconds, scrap, and byproducts. To increase bottom line profits, manufacturers are always on the lookout for mass markets for these items for which they have no further use. Sales are sales. So what is available to the home entrepreneur is the trash leftover from this first skimming by other industries.

A Co-op could maintain an online inventory of available items and materials, sources for tools, and a place to post patterns for sale and use by others. And of course, both streetside and online consignment markets for "trashure" items whether they fall into the category of useful items or just interesting pieces of art and craft. A co-op would offer an environment wherein individual trashure artists can further inspire one another.

A Co-op for Rockhounds

To most of us earthlubbers and perhaps to many less discriminating settlers, a moon rock is a moon rock. "Once you've seen one, you've seen 'em all." A true rock hound knows better. A rockhound can appreciate subtle differences and will know about hidden assets. Rocks can be collected for arrangements in rock gardens, cut and polished to reveal distinctive hidden surfaces, to be incorporated into custom jewelry cabinet hardware. A rockhound co-op could accelerate the diversification of rock and regolith based products by bringing people passionate about rock and its hidden aspects together, purchasing tools and materials at a discount, and setting up streetside and online markets.

University of Luna Assistance

A settlement university should have a department that will encourage the transition from cottage industry through coop membership organizations and activities, to stand alone businesses that employ people full time. In this way the settlement's economy will expand from one consisting of a few basic industries designed to meet minimum consumer needs, to one serving the individual consumer and homemaker, an economy offering an every expanding variety of goods and service. Coops will be the "accelerant."

MM

The First Lunar Manufacturing Industries or, Before we Start Building

H A B I T A T M O D U L E S

By Peter Kokh

Before we can start manufacturing items needed on the growing lunar outpost settlement-to-be, we have to start producing manufacturing materials: metal alloys, glass and glass composites, etc. But this article is not about that. In two previous articles, we looked at manufacturing items in general out of sintered iron fines (using powdered metal technology) [MMM #63 March 1993 p 5. Sintered Iron from powder] and out of Cast Basalt using solar concentrators [MMM #35 MAY 2000. p 7. Cast Basalt: Industry Perfect for a Startup Outpost] Here we want to look at what our overall manufacturing diversification strategy should be.

ASSUMPTIONS: [1] When it comes time to expand our starter outpost, we can't just start building habitat shells without also producing the items needed to outfit them: utility systems, interior partitions including floors and ceilings. [2] To start manufacturing both habitat shells and innards is too big a bite all at once.

PROPOSAL: [3] Why not have the first interim hard hull expansion modules manufactured on, and shipped from Earth built to the same desired cross-section dimensions of our planned made-on-Luna Habitat modules and with the same interior and exterior interfaces? Then we can start manufacturing the sundry outfitting items. When we are ready, we can take on the manufacturing of additional modules on the Moon. [4] The empty made-on-Terra Hab shells can be filled, for transit, with equipment needed for other purposes on the Moon.

Relevant Articles from MMM back issues

MMM #18 September 1988, pp 3-4, "MUS/cle' Strategy for Lunar Industrial Diversification." Online at: www.lunar-reclamation.org/papers/muscle_paper.htm

MMM #74 April 1994; p. 8. "KGB" Drop-in Cores (KGB: Kitchen, Garden, Bath)

MMM #75 May 1994
p 4. Lunar-Appropriate Modular Architecture

MMM #76 June 1994,
p 4. Inside Mare Manor; Interior Walls
p 5. Wall Surfaces & Trimwork
p 8. On the Wall: How to hang stuff;
p 9. Ceilings, Flooring

The "MUS/cle" strategy

Lunar industry should concentrate on the Massive and/or Unitary (we need a lot of such units) and/or Simple items that will make the biggest dent in the gross tonnage that must be imported from Earth and to let terrestrial suppliers continue to produce the more complex and/or lightweight and/or electronic components that in aggregate comprise a lesser gross tonnage to be imported. The earliest lunar manufactures will be things that do not have to be made of refined advanced materials, which are not complex in assembly, and of which we need a lot of, if not in numbers, then in total gross tonnage. Both habitat modules and many of the outfitting items needed to make them occupiable will fit into this category.

Bypassing the dilemma

Now this may seem another instance of the "which came first, the Chicken or the Egg?" dilemma. But I suspect, just as with the age-old question above, the choice is moot if there is

MMM Theme Issues: The Lunar Economy - Years 1-25 Dec 1986 - Nov 2011

no “Rooster” involved. In our case, the question is which to manufacture first: outfitting or habitat shells? The dilemma is solved by the “rooster measure” of having all pressurized modules imported for outpost expansion shipped unoutfitted, basically empty except for things the infant lunar industry cannot yet handle, e.g. the utility runs and electrical harnesses, and so on. The modules of which the original outpost core is built will have come ready to use, of course. But now it is time to expand beyond that core.

The cheapest way to import more habitable space will be with inflatable structures and/or empty and not-yet-outfitted hard hull units. The time for this momentous switch will come when lunar industry has begun producing metal alloys, cast basalt, glass fibers, glass and cement. Made-on-Luna habitat modules could be made of metal alloy, fiberglass reinforced concrete or (fiber)glass-glass(matrix) composites. But meanwhile, these same materials can be turned into modular sections for interior wall partitions, flooring and ceiling systems, tables and other furnishing items which do not need to be made of sophisticated modern materials.

“Size matters”

To make this strategy work, a decision must be made very early on about various interfaces, critical dimensions, etc. What we manufacture on the Moon to outfit empty inflatables and hard hull modules from Earth should ideally be designed to fit the kind of modular architecture and units we will want to build on the Moon. The most critical decision would seem to be radius or cylindrical cross-section. As it will be much more efficient to build two story units, it would be better to use the ET’s 27 ft. girth as a guide, than the 15 ft inner diameter of the Shuttle Payload Bay. New launchers may give us more freedom but we should not count on a Heavy Lifter being developed, no matter how much sense it makes. There is an old maxim about “infrastructure lasting forever.” In very old cities, usually the only thing that survives the ravages of time are the road right of ways. So if we know where we want to end up, perhaps we should design our launchers accordingly. Their capacity enables everything.

Substitution shipments

If for the shipping stages, the shape and size of the cargo alone matters, and weight is less of an issue, other items needed on the Moon, including manufacturing equipment, tools, and small, lightweight “cle” components can be shipped inside the empty habitat hulls in place of the weight that the various outfitting items to be added on the Moon would have totaled. The bottom line is the same. Less shipments and less total tonnage leaves Earth for the Moon. The infant outpost-settlement-wannabe makes up the difference and perhaps then some.

The “Stowaway Import” Option

Let’s say that the infant lunar industry is not yet quite ready to produce some of the outfitting items, but is ready on most. An elegant choice is to ship the Earthmade module with the items that cannot be made yet on the Moon, but manufacture those items out of materials sorely needed on the Moon but in which the Moon is deficient. Copper, lead, zinc (or bronze, brass, pewter); silver, gold, even thermoplastics that can be melted down and recast into items difficult to make from metals, glass, ceramics etc. Such outfitting items can be replaced by made-on-Luna equivalents made of cruder lunar materials, when lunar industry is up to it. At that time, the replaced items can be cannibalized for their rare and precious elements. In effect, copper and the other elements in question get “stowaway” passage to the Moon. [See MMM #65 May 1993, p7. “Stowaway Imports”]

Outfitting for All Modules, or just Some?

Before we begin to develop interfaces and standards for a modular lunar architecture that is versatile enough to meet most needs, we will want to have spent some quality time designing a modular lunar-appropriate architectural “language.” In this language, the interfaces are the grammar, the various types of modules are the nouns and verbs. In our article in MMM #75 on Modular Lunar Architecture we postulated that a successful Lunar-appropriate system would be one that incorporates these Six Elements:

1. The smallest number of distinct elements

MMM Theme Issues: The Lunar Economy - Years 1-25 Dec 1986 - Nov 2011

2. The greatest layout design versatility
3. The most diverse interior decorating options
4. Fabricated with the least labor and equipment
5. Assembled with the least EVA and equipment
6. Apressurizable after the least total crew hours

Now it is conceivable that Lunar industry will be ready to outfit some kinds of modules, say dormitory units residence units, or agricultural pods, before it is ready to produce drop-in kitchen-bath units, for example. In this case, we make the most appropriate choice between ship-ping some modules fully outfitted, others empty, still others with temporary replaceable and cannibalizable items. The point is that the transition from shipment of fully outfitted units to shipment of wholly unoutfitted ones need not be an all or none decision. We can phase this in, easing the transition, building up confidence and experience in the new lunar industrial teams.

What outfitting items will be manufactured first?

We go back to the MUS/cle strategy for guidance. What outfitting items, easy enough for lunar industry to tackle now, will, multiplying individual item weight by the numbers needed, make the biggest dent in the import burden? Interior wall, flooring, and ceiling systems perhaps. If these are modular, combinations that fit inflatable interiors should produce no extra manufacturing burden. Planter trays for the agricultural units, for sure.

If we can come up with a modular way of making a number of case goods items (cabinets, tables, dressers, desks, etc.) then the various components of those. What about utility components? Pipes and conduit would get the nod over switches and valves, even over elbows and tees. You get the idea. The MUS/cle strategy makes decisions and diversification strategizing a fairly straightforward process in which consensus replaces power plays by those seeking personal economic advantage.

Special Assemblies

As manufacturing volume and diversification both increase, the market for special assemblies will grow to the point of making it worthwhile to produce them. For example, the round hemispheric end of a habitat module Teed off of a residence modular complex, provides a specially shaped concave area right for mass-production of alternative units made to fit. The illustration below illustrates possibilities.

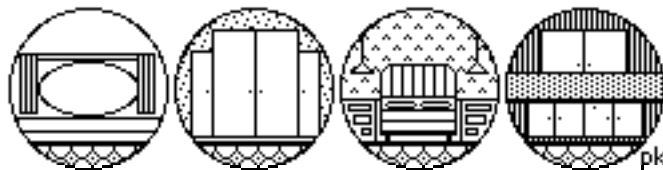

L-R: periscope picture window unit, closet system, bed headboard wall, countertop with upper & lower cabinets.

The point is to get started. Here is a path from outpost expansion to settlement building in earnest, that is just-on-time, versatile, and which makes economic sense. For most writers, getting from the starter outpost to the first settlement is a mysterious transition to be taken for granted. MMM is all about life on the early frontier, not about the first foothold outpost. "Getting There" for us is not the rockets that emplace the starter outpost, but rather the staged rocket of infant lunar industry that will get us to the early lunar frontier populated by pioneers who have left Earth behind, ready to make this new world their new home.

MMM

Scientific-Industrial Utilization of the "Lunar-Unique" Environment

By Peter Kokh

- **High vacuum** (vastly cleaner and higher than in LEO)
- **No global magnetic field** (unlike in LEO)
- **Fractional gravity** (mechanical advantage over LEO's 0-g)
- **Minimum atmospheric activity** (levitated dust at dawn)
- **Sterile environment** (no air, water, soil pollution)
- **Slow rotation** once every 29.5 Earth days
- **Minimal seasonal thermal variation** (3° F/C?)
- **No humidity/water vapor**

The challenge is to identify scientific, chemical, and industrial processes that one or more of these unique environmental characteristics makes practical or possible on the Moon that are impractical if not impossible here on Earth or in Low Earth Orbit (i.e. at ISS or other future orbiting laboratories or factories).

Yes, you've heard a similar question posed before: what can we do in the micro-gravity of Earth orbit that we cannot do here on Earth's surface? We have yet to find potentially profitable and practical applications for processing and manufacturing at "zero-g" ("micro-g" may be more picky-accurate) in space stations and orbiting factories. But that should not discourage us from looking for similar advantages that the Moon's unique environment may offer.

That LEO offers zero-g and the Moon only 1/6th gravity is not grounds for dismissal. "Fractional gravity" may preclude some chemical processes but it confers a very real mechanical advantage to material handling and other mechanical operations. And the Moon offers advantages that LEO or other orbital locations do not.

The vacuum above the surface layer that is periodically "spoiled" by levitated electrostatic dust at dawn is much cleaner than the permanently dust and debris ridden low Earth orbit area, simply because that light one-sixth gravity continually purges that vacuum of foreign material including corrosive free oxygen.

LEO is very much affected by Earth's global magnetic field. The Moon, lacking such a field, has the advantage whenever background magnetism can affect a chemical or physical reaction negatively.

The Moon supplies an extensive seismically quiet (in comparison to Earth) platform for use of **global telescope arrays**. The only disturbances come from impacts, not tectonic plates in movement. Are there other advantages to this seismic quiet that may benefit research or industry?

That the payoff is yet to come from the so-called advantages of "doing it in Earth orbit" should not dissuade us from looking for possible processes and research that are uniquely favored by the special combination of scientific environmental assets given above to "doing it on the Moon."

If there are no areas of industrial and scientific activities better suited to the Moon than to either Earth or Mars, that would be surprising. The payoff to those advantages we find and are able to leverage could make minor contributions to the economic viability of lunar settlement. But until we find out otherwise, we cannot rule out the possibility that the payoff could be economically significant.

This line of research is certainly worth pursuing, and some of this research may not need to wait until we find ourselves on the Moon with adequate laboratories and other facilities. The issues are technical, however, and it is for specialists in each of the many areas of science and industry to try to identify operations that would benefit from the "Lunar-Unique" environment.

MMM Theme Issues: The Lunar Economy - Years 1-25 Dec 1986 - Nov 2011

If lunar settlement and industrialization is to be viable, every area of possible advantage must be explored and pushed to the limit.

Some likely applications:

Biology

- **Quarantine Lab** for Mars Sample Returns, Europa Sample Returns

Astronomy

- **Radio and Optical Telescope Arrays** (interferometers)
- **Northern and Southern hemisphere telescopes** that can be set on a given stellar object 24/7/365 (vs. a fraction of each day for only a part of the year)
- **Very large Arecibo-type radio dishes** in craters, of which many thousands would be suitable

Energy

- **Solar power arrays**

Architecture/Construction

- **Very tall towers** are possible, kilometers high, for observation, relays, cable & cableway suspension, etc.
- **Extensive use of Magnesium and iron** for surface construction it (both would quickly oxidize on Earth)

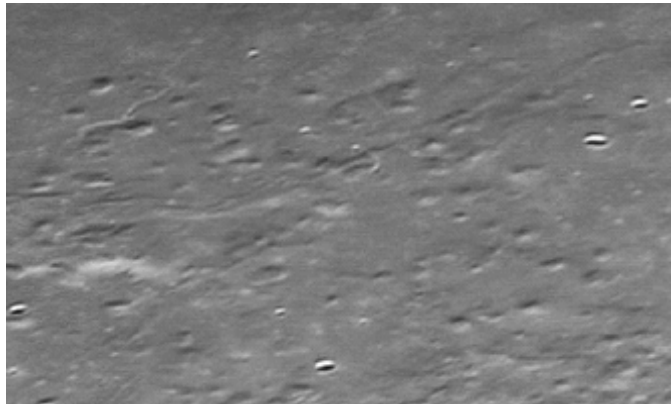

THE MARIUS HILLS (14°N, 56°W)

LPOD: Lunar Photo of the Day January 21, 2006 (portion of photo)

- This is the largest volcanic complex on the Moon (neglecting all the maria, of course) and no one understands why it exists.
- It appears that the entire area may be slightly higher than the surroundings, like a miniature ... of the Aristarchus Plateau.
- The Marius Hills includes hundred of slightly steep hills and flat domes and three sinuous rilles.

Spectral studies show that the steep hills have volcanic ash on them, indicating that explosive eruptions built them. The domes were formed by non-explosive flows of lava. And the sinuous rilles probably formed from greater rates of flow of lavas. -- Charles Wood [1]

This Originally Intended Landing Site for Apollo 17

MMM Theme Issues: The Lunar Economy - Years 1-25 Dec 1986 - Nov 2011

could have Changed History. It may change the Future!

By Peter Kokh and David Dietzler

What has intrigued us is the suspicion that the Marius Hills might someday be the Ruhr of the Moon, (its major industrial complex) and make an outstanding site for a major settlement.

The Hills offer:

- Variations in basalt
- Perhaps a good number of intact lavatubes
- Possible or likely pockets of unreleased volcanic volatiles that could change the prognosis for industrial development of the Moon.



This area appears to have experienced a number of lava/magma flows, each successive flow somewhat different chemically than the one before – “layered igneous intrusions”. in geological parlance. On Earth, the most significant case is. The Bushveld area in South Africa, source of much of that country’s mineral wealth. The reserves of **chromium, platinum, palladium, osmium, iridium, rhodium and ruthenium.** are the world's largest along with vast quantities of **iron, tin, titanium and vanadium.**

[2] South Africa is second only. to the United States in the production of mineral resources..

The elements listed above are essential to a modern industrial complex.

If the Lunar Frontier were to rely only. on the elements most abundant on the Moon, oxygen, silicon, iron, aluminum, titanium, magnesium, and calcium, the result. would be something like late nineteenth century industry, more than an advanced New Stone Age” but not much more..

Lunar industry must find, or import at great. expense, copper, gold, silver, platinum, zinc, lead, and other. metals not well represented in the regolith at large.

The Clementine and Lunar Prospector data have yielded helpful. maps, but their resolution leaves much to be desired. New. orbiters with more sensitive instruments able to detect. specific signatures at very high resolution are essential.. Prospecting from orbit is extremely cheap in comparison to. fielding and supporting a veritable army of human prospectors. on the ground! The later will be needed in time, but. they are best used in areas targeted for further “ground. truth” investigation by orbiting chemical sleuths..

Clementine, Lunar Prospector, and Truth in Science

These orbiters have clearly shown that

MMM Theme Issues: The Lunar Economy - Years 1-25 Dec 1986 - Nov 2011

- **The Nearside Mareplex is much richer in iron, titanium, thorium and other useful elements than highland sites.**
- **The poles, in contrast, have little of industrial significance** beyond the yet to be “ground truth” qualified and quantified hydrogen enriched permashade areas, and more round-the-month low angle sunlight in mountainous terrain that may be risky to traverse (ever-changing very long ink black shadows as well as anything but level) with irregular plateaus of “eternal sunrise”

(To use the term “eternal sunshine” is very misleading.) At the poles we may find water ice of yet unknown purity and mixture with regolith, and of yet unknown friendliness to mining techniques, and nothing to do with it except waste it as one-time-use rocket fuel.

But these same Clementine and Lunar Prospector maps do not tell us where the real prizes are to be found, if anywhere. But looking at topographical and geological characteristics, the Marius Hills area certainly looks intriguing, perhaps even promising.

Questions and more questions

David writes: study of the impact craters in the region revealed none that had penetrated through to the underlying highland bedrock. So if there are underground chambers, “vesicles,” of volcanic gas, they might be intact.

So much for the “Moon is all homogenized, contains no surprises, the crust is all fractured, gas would have all leaked out” theory that I have come to believe is entirely false. I say this region could be like a volcanic gas field, truly a gold mine for lunans. One can see that there are no giant craters there or fissures in the surface.”

Peter: I checked the reports on TLP, transient lunar phenomena which might include leaking gas. This does not seem to be a “TLP area,” unlike the nearby Aristarchus Plateau, which is the source of many TLP reports. But the major difference is that in the Aristarchus Plateau, we have a major relatively recent impact crater, Aristarchus itself, which has clearly penetrated into the highland crust underlying the basalt flows which formed the plateau.

David: clearly any gas in fractured basalt has already long escaped. I am growing confident that there may be intact pockets of volcanic volatiles in unfractured layers. Ground penetrating radar and landing teams with explosives and sonic sensors like the stuff they use for oil exploration are what we need. What we have to do is create a vision for others to be inspired by.

Volcanic Gases? The Envelope, Please!

On Earth, more than molten rock, thick fire-red lava escapes from the throats of active volcanoes! See: <http://volcanoes.usgs.gov/Hazards/What/VolGas/volgas.html>

“At high pressures deep beneath the earth's surface, volcanic gases are dissolved in molten rock. But as magma rises toward the surface where the pressure is lower, gases held in the melt begin to form tiny bubbles. The increasing volume taken up by gas bubbles makes the magma less dense than the surrounding rock, which may allow the magma to continue its upward journey. Closer to the surface, the bubbles increase in number and size so that the gas volume may exceed the melt volume in the magma, thus creating a magma foam. The rapidly expanding gas bubbles of the foam can lead to explosive eruptions in which the melt is fragmented into pieces of volcanic rock, known as tephra. If the molten rock is not fragmented by explosive activity, a lava flow will be generated.”

“The most abundant gas typically released into the atmosphere from volcanic systems is water vapor (H₂O), followed by carbon dioxide (CO₂) and sulfur dioxide (SO₂). Volcanoes also release smaller amounts of others gases, including hydrogen sulfide (H₂S), hydrogen (H₂), carbon monoxide (CO), hydrogen chloride (HCL), hydrogen fluoride (HF), and helium (He).”

Now given that the Moon was apparently formed from material from which any native volatiles had been driven off by heat, we will be most unlikely to find water or water vapor or hydrogen, either alone or in combination.

MMM Theme Issues: The Lunar Economy - Years 1-25 Dec 1986 - Nov 2011

The Moon is also apparently “under-oxidized.” Even though the regolith and the crust from which it is derived by impact gardening is 45% or so oxygen by weight, in the form of metal oxides and silicates, there is not enough oxygen to have rendered the vast majority of the Moon’s crustal iron into the ferric form, Fe₂O₃ predominant on Earth. The iron we find is predominantly ferrous, FeO, or even pure, not oxidized at all. That leads us to suspect that the fully oxidized forms of carbon and sulfur are also unlikely. Instead of carbon dioxide, we will be lucky to find carbon monoxide. Instead of sulfur dioxide, we will be lucky to find sulfur monoxide. Helium is also unlikely.

As there is enough sulfur, and enough oxygen in the regolith, the presence of SO gas is of no interest. The prize, perhaps the sole prize, as we see it, is pockets of carbon monoxide, CO, which would be most invaluable, both as a handy industrial reagent in itself, and as a source of carbon which is vital to life in all forms, as well as essential in making steel. We may never find enough carbon on the Moon to use profligately in plastics and other synthetics.

Gas pockets may be too small and insignificant in volume to show up as “negative mascons”, even at highest resolution. Radar designed to ferret out lavatubes might find such pockets. They would have characteristic shapes noticeably different from the long tubular lavatubes.

The discovery of substantial carbon monoxide reservoirs on the Moon would rival the discovery of polar permashade ice reserves in brightening the prospects for fuller industrial diversification, and the chances of attaining economic self-sufficiency. We had previously considered the possibility of finding such “lacunae” (to suggest a Latin topographic term) but The Marius Hills are the first site to suggest that “here is a good place to look.”

We have a lot of prospecting homework to do on the Moon before we can be confident that any reestablished human presence on the Moon has a real chance of an open-ended future. Most lunar probes are designed by scientists with things on their minds other than resources. Scratching the itches of scientific curiosity is good. But it is not what we need. This should guide what missions we support. **MMM**

The best way to predict the future is to be busy creating it.

Measure a man by the opposition it takes to discourage him.

Judge a man not by where he has come from, but by where he is headed.

No grimmer fate can be imagined than
That of humans, possessed of godlike powers,
Confined to one single fragile world."

-- Kraft Ehricke

MMM # 198 September 2006



MMM Theme Issues: The Lunar Economy - Years 1-25 Dec 1986 - Nov 2011

THE OUTPOST TRAP Technologies Needed to Break Free

By Peter Kokh

Despite the best of current announced intentions, it is politically and economically predictable that NASA's lunar outpost (even if is "internationalized" by taking on "partners" in a contract) will be stripped of any and all features seen as "frills" or "extras." Consider how the planned 7-man International Space Station was summarily slashed without partner consultation in the stroke of a presidential pen to a 3-person one: 2.5 persons needed for regular maintenance and a half-person is available for scientific research. It can and will happen again, unless ...

It becomes our cause, the accepted challenge of those of us who owe it to our own dreams, to do every-thing in our power to get the outpost built, outfitted, and supplied on a more rigorous and stasis-resistant path. The/a lunar outpost must be designed with expansion in mind, with a suite of easy expansion points, expressing an architectural language that is expansion-friendly. No all-in-one "tuna can stack," please!

To this end, we must reexamine every aspect and angle of setting up a lunar outpost.

I. Transportation System Architectures: Designing cannibalizable items for strategic reuse in Earth-Moon Transportation Systems.

NOTE 1: The author is not a rocket scientist, engineer or architect. The examples given below may not all be feasible, but we hope that those that are not, will suggest other possibilities that are worth exploring.

NOTE 2: We do not expect NASA to embrace any revolutionary space transportation system architectural turnabout. But it is something that commercial space transportation providers might do well to study.

NOTE 3: Those in the business may be quick to insist that these ideas are all impractical. So be it. They are not part of the solution. We are looking not for those who say "it can't be done," but for those who say "we'll find a way to do it anyway!" If it were not for the "Young Turks" in various fields, we would all still be swinging from the trees. We must find the hidden, unsuspected pathways!

Way back in MMM #4, April 1987, we pointed out that Marshall McLuhan's dictum that "the media is the message," might be transposed to "the rocket is the payload." Of course, you can only push this so far. But this daring architectural philosophy offers the best way to escape the imagined, unnecessarily self-imposed tyranny of the mass fraction rule. "Of the total weight, 91 % should be propellants; 3 % should be tanks, engines, fins, etc.; and 6 %t can be the payload."

<http://www.allstar.fiu.edu/AERO/rocket5.htm>

We are not talking about exotic fuels or better rocket engines, but ways to include the 3% "tanks, engines, fins, etc." into the payload.

In the case of the Shuttle, the mass of the vehicle is much greater than the mass of the payload, so we do not come close to the ideal. At the time (the April 1987 article), I offered this simple example. In the shuttle space transportation system, the payload that gets to stay in orbit is a needlessly small portion of launch vehicle mass.



Adopting philosophy "the rocket is the payload" we could, if we so dared, deliver much more to orbit.

MMM Theme Issues: The Lunar Economy - Years 1-25 Dec 1986 - Nov 2011

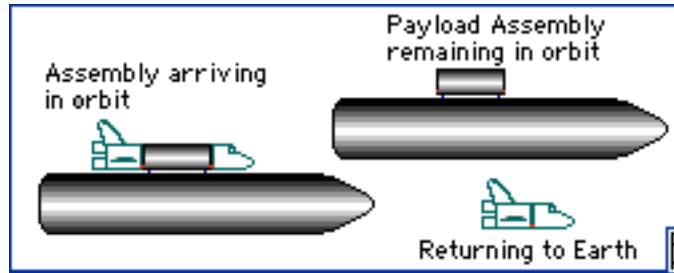

In the suggested alternative, the orbiter has a fore and aft section: Crew Cabin and Engine pod with much smaller wing/tail assembly. There is no payload bay. A much larger payload, with a lightweight faring if needed, takes its place. The External Tank is also placed in orbit as part of the payload. A stubby shuttle is all that returns to Earth. Savings include not just the payload bay section but the much lighter smaller wings and tail. The article referred above to is reprinted in MMM Classic #1, p 10, a freely accessible pdf file at:

www.moonsociety.org/publications/mmm_classics/

Again, don't waste time writing MMM with all the reasons this couldn't be done. Instead, consider yourself challenged to figure out how we could do this anyway.

This is only one suggestion of how we can "cheat" the mass-fraction "rule." The shuttle system will not figure in the establishment of a lunar outpost. So it is not these details, but the spirit behind them that we are trying to get across. Attitude, attitude, attitude!

Terracing the way back to the Moon

It seems unlikely that the Lunar frontier will be opened with vehicles that depart Earth's surface, make the entire trip out to the Moon, and land on the Moon's surface directly. So what we have to examine is all the various parts:

- Earth surface to LEO (low Earth orbit) transports
- LEO to Earth Moon L1 or Low Lunar Orbit ferries
- Lunar orbit to lunar surface landers

At each phase, if the vehicle addresses the design challenges, material and/or useful assemblies and sub-assemblies can be deposited at the next. Whether it be all in one ride, or by a succession of waves, more payload gets delivered to the Moon's surface, and/or more robust way stations are constructed in LEO and LLO (low Lunar orbit) or at the L1 Lagrange point. No opportunity is missed. See "The Earth-Moon L1 Gateway" MMM #159, OCT 2002. You can download this issue freely at:

http://www.lunar-reclamation.org/mmm_samples/

We would be remiss if we did not point out that one of the most brilliant components of the **Artemis Project**TM Reference Mission architecture involved just such a mass-fraction cheating device: reduction of the portion of the landing craft that "returns" to the open-vacuum "space motorcycle" I think it can be shown that most objections to this design as vulnerable to micro-meteorite impact are baseless. Micrometeorites strike the Moon, and space-suited astronauts!, on the surface, with velocities much higher than the velocity such a craft would need to reach lunar rendezvous orbit. It was the incorporation of this feature that allowed the Artemis ProjectTM ferry to deliver the relatively massive triple unit SpaceHab-based outpost core to the surface.

Whether the Artemis ProjectTM Reference Mission will fly as designed is not our topic and irrelevant. The point is that it demonstrates, at least in this instance, the kind of breakthrough paradigm-scuttling innovation that alone will get us to the Moon "to stay."

Stowaway Imports: smuggling more to the Moon

Another article we wrote that suggests ways to "smuggle" more useful material and items to the Moon is "Stowaway Imports" in MMM #65, May 1993. This article is republished in MMM Classics #7, freely downloaded at www.lunar-reclamation.org/mmm_classics/ - or at www.moonsociety.org/publications/mmm_classics/

MMM Theme Issues: The Lunar Economy - Years 1-25 Dec 1986 - Nov 2011

The idea here, is that it is inevitable that there will be structural, outfitting, or packaging items aboard craft landing on the Moon that are not needed for the return to the vehicle's base, be it in LLO, LEO, or Earth itself. The cost of getting these items to the Moon is prepaid as part of the cost of getting the payload consist to the Moon, whether or not they remain on the Moon or not. So if we leave them there, these items are a bonus.

Packaging containers, stuffing, dividers, etc. can be made of items not yet possible to duplicate on the Moon: some Moon-exotic element such as copper, or an alloy, some reformable plastic, biodegradable materials useful as fertilizers, nutritional supplements, whatever. Everything not absolutely needed for the ride back is game for scavenging. On crewed vehicles this can consist of everything from tableware to bedding, to appliances and even cabin partitions.

Some items can be thoughtfully predesigned for second use on the Moon as is. Others will be melted down or reformed for the useful material they contain. It's all free, or at least at less cost than replacing them for the next outbound trip to the Moon. Only the "squeal" need return!

Designing moon-bound craft to be cannibalized in this fashion will require resourcefulness, and exploration of a lot of options, some more promising and less difficult than others. Stowaway imports are a way to supplement what personnel on the Moon will be able to produce or fabricate for themselves, thus leading to swifter development of a more diversified lunar startup economy.

Cargo craft landing on the Moon might be designed for one way use only. Fuel tanks will be prize imports, landing engines may be reusable for surface hoppers. The idea is to build these craft cheaply and in numbers, much in the mold of WW II "Liberty Ships." If some crash or go astray, the loss will not be critical.

In our Lunar Hostel's paper (ISDC 1991 San Antonio, TX - www.lunar-reclamation.org/papers/) we introduced the "frog" and the "toad" - Moon ferry under-slung crew cabins that could be winched down to the surface, lower its wheeled chassis, and taxi to the outpost: amphibious space/surface craft. The "frog" would return. The "toad" would be designed to spend the rest of its service life on the Moon as a surface transport "coach."

Modular Transportation

One of the more outstandingly successful innovations of modern transportation is the pod. Cargo in uniformly sized and shaped pods is transported on trucks, flatbed railway cars, and ocean going cargo ships.

The space transportation industry, especially the commercial sector, would do well to develop standardized pods, not waiting upon NASA clues which may never come, simply because the need does not arise in the very limited NASA lunar outpost mission plan. There may be more than one pod design, however, depending on the nature of the cargo. Liquids and aggregate materials (a load of wheat, for the sake of an example) may require container constraints, for shipment through the vacuum of space, that large assemblies do not.

The pod agreed upon would have significant repercussion for modular systems shipped to the Moon: modular power plants, modular water recycling systems; modular regolith processing systems; modular food processing systems; modular hospital cores; the list of possibilities is endless. No one size is ideal for all applications. However, we suggest that the current modular factory system serve as a model and size guideline, as it has proved remarkable successful. See MMM #174 April, 2004 "Modular Container Factories for the Moon." [above, pp. 74 ff.]

Such a pod could also deliver inflatable modules to the Moon, which could then be outfitted on location, with cannibalized components and/or items manufactured by startup lunar industries. The result would be quicker build-out of the original outpost structure.

Transportation Systems Architecture Upshot

If we intend to expand the outpost into a real industrial settlement on an "inflationary fast-track" - the only way it can be done economically - the Earth-Moon transportation system

MMM Theme Issues: The Lunar Economy - Years 1-25 Dec 1986 - Nov 2011

must be so-designed from the gitgo, down to the last seemingly insignificant detail. A missed opportunity could spell the difference between success and failure. Our purpose in giving the examples above is less to fix attention to our examples than to get across the spirit. Spacecraft architecture, systems architecture, industrial design for reusability as is or with minimum processing effort, choice of materials, etc. And all vehicles at every stage should be designed this way.

Again, these lessons will be lost on NASA as its objectives are strictly limited: to deploy a moonbase in order to prepare for manned exploration of Mars. “.” But commercial providers are likely to look for more extensive use of their products, for other more open-ended markets. It is with them that all hope lies. Those that adopt the above philosophy as a cornerstone of their business plans are more likely to survive and thrive long after NASA’s government-limited goals are met.

II. An Expansion-friendly Modular Outpost Architectural Language, and Construction/Assembly Systems Design

Back Reading:

MMM #5 May '87 “Lunar Architecture” [above pp. 6ff.

MMM #75 May '94 “Lunar-Appropriate Modular Architecture” MMM Classics #8

http://www.moonsociety.org/publications/mmm_classics/mmmc8_Jan2006.pdf

– pp. 22 ff.

MMM #101, December 96 “Expanding the Outpost”

This is one area in which the **Russians** and **NASA** with its various **contractors**, have already done considerable research and have acquired invaluable in-flight/in-use experience in the **Mir** and **International Space Station** programs. Happily too, a commercial contractor, **Bigelow Aerospace** is now making groundbreaking contributions with inflatable module technology, borrowing heavily on NASA’s Congress-aborted TransHab project. The prototype one quarter scale inflatable **Genesis I** is now in orbit and rewardingly performing well.

Modular architecture developed for the micro-gravity of Earth orbit will certainly have applications in the return to the Moon effort. It will apply directly to any way station developed at the L! Gateway point or in lunar orbit. But applications to the design of lunar surface outposts will need some rethinking for four reasons:

We are now talking about a 2-dimensional environment stratified by gravity, not the any-which-way dimensions of orbital space. The 1/6 Earth normal gravity environment mandates an established up-down orientation, no “swimming” through the air to get from one point to the other. This is minor.

Egress and ingress portals need to be designed to minimize intrusion of insidious moon dust. It would be ideal if spacesuits were rethought with this challenge in mind, but NASA has already signaled its intention not to explore that route for money reasons. One more sorry instance of a “stitch in time, saves nine.” NASA operations on the Moon will be far more expensive to maintain than the relatively trivial expense of wholesale spacesuit redesign even at multimillion dollar expense. Commercial contractors may be the Knights in Shining Armor here as the NASA approach would be indefensible in any business plan.

Outside the safety of the Van Allen belts, radiation protection is required for more than short stays. The lunar surface station must be designed to sit under a shielded canopy, or to be directly covered with a regolith blanket. An added benefit will be thermal equilibrium.

While NASA, its contractors, and the Russians have a head start, it should never be assumed that they have explored all the options. Modular architecture is very much structured like a language: it has nouns (the various habitat and activity modules), conjunctions and prepositions (the various connector nodes), and verbs (the power system, the Canadarm and other associated assembly and arrangement tools). The idea in constructing a “lunar-

MMM Theme Issues: The Lunar Economy - Years 1-25 Dec 1986 - Nov 2011

appropriate modular architectural language” is to come up with the most versatile, yet economic in number, set of modular components to support the most diverse and varied layouts and plans. The idea here is to maximize the options for expansion, without prejudging what needs will be accommodated first in the buildout.

We think that this concept is important enough to put to a design competition. NASA, contractors, the Russians can all advise on interface constraints and other design features that must be incorporated. Then let the would be Frank Lloyd Wrights of the lunar frontier have at it. We predict some novel suggestions that NASA and commercial contractors may want to adopt.

We have suggested in Part I of this article, that modules should fit (yet-to-be-)standardized Earth-Moon shipping pods. The cheapest way of providing maximum elbow room, in the era before modules can be manufactured on the Moon out of lunar building materials, will be inflatable modules. Easy to deploy “outfitting systems” for these inflatable units are another area worth exploring through the device of an international design competition. The inflatable manufacturer can set the constraints which will include interior dimensions, purchase points, and ingress opening sizes. Then let the contestants exercise their varied inspirations.

Onsite manufacturability of needed components would be a design goal: maximum use of low-performance cast basalt, glass composite, and crude alloy items should be the preferred contest category. This way, expansion develops hand in hand with early startup industries, and becomes a strong incentive for their earliest development, saving substantial sums over importation from Earth.

Expanding on this theme, even equipment in hard-hull modules arriving fully outfitted from Earth might be limited to subassemblies of components not yet manufacturable on the Moon. A very simple example would be cabinets, tables, floor tiles, even chairs without horizontal tops or seats. These could be made of cast basalt, saving some weight in shipment. Many more possibilities of this compound sourcing paradigm are worth exploring: wall surfacing systems, simple utensils, appliance chassis, etc. See MMM #18, Sep. '88, “Processing with Industrial “M.U.S./c.l.e.” [above pp. 16 ff.]

We mentioned the need for shielding. The development of simple canopy framework systems that can be locally manufactured, then covered with regolith, would be invaluable. Such canopies could protect stored fuel and other warehoused items that need to be accessed regularly, so that personnel could do these routine chores in less cumbersome pressure suits as opposed to hardened spacesuits. Such canopies could also serve as flare shelters out in the field at construction sites or at periodic points along a highway. An easily assembled (teleoperated?) space frame system with a covering that would hold a couple of meters (~yards) of regolith should be another design contest goal.

Modular Power Generation, Storage, and Heat Rejection Systems

This is a suggestion that NASA may well not bother considering. The initial outpost power generation and storage systems and heat rejection systems should be designed with modular expansion in mind. NASA will not be reflecting on the needs of expansion because its government mandate does not extend to expansion, unless space advocates force a change, even if “just to leave the door open for commercial developers who may follow.” We think such activism is worth the effort.

Introducing Load-based Modular Biospherics

In our opinion, NASA’s performance in developing life support systems has been hit and miss. Chances to incorporate a higher level of recycling on the Space Station were passed up in the name of up front economies, even though such systems will be absolutely vital on the Moon and Mars. To its credit, the agency does have the BioPlex project in full swing in Houston. But we worry that the outcome will be a centralized system that will work for the designed size of the lunar outpost, and not support further expansion.

The centralized approach to biospherics has a famous precedent: Biosphere II. We think centralized approaches are not the way to go. Instead, we should develop load-based

MMM Theme Issues: The Lunar Economy - Years 1-25 Dec 1986 - Nov 2011

decentralized systems. In this approach, wherever there is a toilet – in a residence, a workspace, a school, a shopping area, a recreation space, etc. there should be a system to pretreat the effluent so that the residual load on a modular centralized treatment facility is minimized. The Wolverton system is what we have in mind.

If all outpost modules with toilets have built-in pretreatment systems, then, as the physical modular complex grows by additions, the “modular biosphere” will expand with it. Expansion will not race ahead of the capacity of the contained biosphere to refresh itself.

Another essential element of modular biospherics is having plants everywhere. A phone-booth sized salad station will not do. Useful plants can be grown throughout the lunar outpost: they can provide additional salad ingredients and meal enhancers: peppers, herbs, spices, even mushrooms. Even decorative foliage and flowering plants help keep the air fresh as well as provide a friendly just-like-home atmosphere. Plants in front of any window or viewing portal would filter the stark and sterile barrenness outside.

Plants must not be an afterthought. We cannot long survive, let alone thrive as a species that hosts houseplants. We are a species hosted by the lush vegetation of our home world. We should never forget this. We cannot go with the attitude of “let’s build some cities, and a token farm here and there.” Rather we must go to build a new vegetation-based but modular biosphere which will then host our settlements.

City dwellers all too easily discount the farm. We have houseplants as botanical pets. That paradigm won’t work. Designing all habitation and activity modules to house plants as an integral feature will help allow the biosphere to grow in a modular way along with the physical plant. It will be a more enjoyable place to live as well.

NASA is unlikely to pay these suggestions a glancing thought. We hope that commercial contractors, whose long range plans are not limited by governmental myopia are more farsighted. Modular biospherics should be part of their business plans for any industrial settlements or tourist complexes on the Moon.

Teleoperation of construction & assembly tasks

So far we have been talking about architectural considerations that would prime any startup lunar outpost for expansion, no matter how restricted its mandated goals. But expansion, as well as original deployment, requires construction and assembly. To the extent that individuals in spacesuits are involved in this work, it will be dangerous and risky. Human manpower hours on the Moon will be expensive to support. Loss or incapacitation of just one person in an outpost construction accident would be a major and expensive one.

In order to maximize crew usefulness and productivity as well as health and safety as many tasks as possible should be designed for remote operation by persons safely inside the outpost or construction shack, or by teleoperation by less expensively supported people back on Earth. The latter option may be more technologically demanding but it is far more preferable. Every construction operation tele-controlled from Earth frees personnel on the Moon for things that only personnel on site can accomplish. The result is progress is surer, safer, and yet quicker. The outpost is up and running in less time, with everyone healthy and ready for real duties.

In the following article, page 7 below, we take up this fascinating topic of pushing the limits of teleoperation, surely a prime area for engineering competitions.

III. Locate for local, regional, and global expansion options

The writer’s position on moonbase siting is well known. We have no problem with being all alone in seeing a lunar south polar outpost as a dead end. But we hope that commercial contractors will be more farsighted. The problem is that we need to plan not just one outpost, but an outpost that can be a center from which an industrious human presence will spread across the lunar globe.

In their very well brainstormed proposal outlined in “**The Moon: Resources, Future Development and Colonization**”, David Schrunck, Burton Sharpe, Bonnie Cooper, and Madhu

MMM Theme Issues: The Lunar Economy - Years 1-25 Dec 1986 - Nov 2011

Thangavelu present a comprehensive plan for establishing such an outpost at the south pole and for spreading out from that center across the globe via an electrified lunar railroad. We certainly support the latter idea and have written independently on the feasibility of electric lunar railroads.

But we fear that south pole advocates have discounted the dangers of operating in a polar environment, in mountainous terrain, where the sun is always at or just below the horizon or immediately above it casting constantly shifting “blackhole-black” long shadows. We also suspect that the difficulty of deploying a solar power tower system in mountainous terrain is not addressed. That the nearest highland/mare “coast” where resources of both terrain types needed for industrialization are accessible is 1,300 miles distant is another overlooked disadvantage. That sunlight is available 86% of the time does not erase these drawbacks.

Water-ice may exist at the poles. But hydrogen is everywhere on the Moon in the regolith, ready to harvest. As much as we need water, we will use far greater tonnages of other materials. Do we bring Mohammed to the Mountain or the Mountain to Mohammed?

There is, it seems, an unstoppable bandwagon for the South Pole. Commercial contractors interested in developing lunar resources and/or tourist facilities, are likely to take a second look. Our hope lies with them.

A NASA-International lunar polar outpost may survive, minimally manned to tend astronomical observatories in the area. If we mine polar ice preserves it makes more sense to do that in the north polar areas. If the observatories go unsupported, one day, lunar tourists may visit the historic ruins at the South Pole.

Parts IV & following, Next Month

In next month’s installment of “**The Outpost Trap: Technologies Needed to Break Free**” we will talk about ISRU, In Situ (onsite) Resource Utilization, processing the most common elements in the regolith and producing building materials. We cannot thrive on oxygen alone! Any effort to do so will end in outpost termination.

We will also explore the ways to get lunar industrialization off on the optimum path to a logical diversification that will build upon itself and reach import-export expense-income break-even as quickly as possible.

Lastly, we will explore the demands of the most critical of all moonbase systems, without which all the rest, no matter how well designed, will collapse, or at the very least totally preclude civilian expansion of the kind most of us want to see: “the human system”. This is the system currently being viewed with the most rusty-hinge horse blinders, and not just by NASA.

Meanwhile, a parting thought

While no one has ever established an outworld outpost before, we humans have certainly had plenty of experience in establishing new frontiers. There is a substantial reservoir of experience here throughout human history and in many human cultures, on which to draw.

Establishing an outpost, whether or not new and complex equipment is needed, is much more than a matter of nuts and bolts, of engineering and rocket science. To rely solely on the insights of experts in those professions will only gain us an expensive collection of hardware on the Moon. It will not gain us the open-ended establishment of a civilian, resource-using presence bent on making itself as much “at home” on the Moon as we have always done, over and over, everywhere that we have pioneered new frontiers on our home world.

In a sense, this will be a second Cradle Breakout. We are, you see, already an intra-planetfaring species. We have already settled new “worlds” in our “Continental System” beyond home continent Africa. The next step is only a continuation. But we must rely most of all on our instinctive cultural wisdom based on millennia of experience by endless waves of pioneers who have gone before. The upshot is that NASA and other agencies must fit in our plan, rather than we in theirs.

Much of the expertise needed will have to be developed or at least rethought. Here we need to rely not solely on those “tasked” with working on the project. After all, it is our project,

MMM Theme Issues: The Lunar Economy - Years 1-25 Dec 1986 - Nov 2011

not theirs, and no government has the right to exclusively appoint any set of specialists to the task. This frontier like all others, will be pioneered by rebels, by those unhappy with the status quo, by Young Turks who dare to look at old problems in a fresh light, by people who are willing to dust off the countless pages of abandoned research, looking for promising turns in the many "paths not taken."

And we need the entrepreneurs who will develop these new technologies now, for profitable terrestrial applications, but ultimately to put them "on the shelf" just in time where lunar pioneers can find them when needed.

As a Society tasking ourselves with doing what we can to make it happen, we need to seek out "adventurous expertise", well researched but yet open minded persons who will make the breakthroughs, large and small, that will help realize the dream. <MMM>



Teleoperation: getting the most productivity from our personnel on the Moon

By Peter Kokh

Tele•e•o•o•per•a•tion: remote control operation of untended equipment; radio-control

Actually, "teleoperation" is a relatively new word coined by space development writers. Even though we have been using it for two decades or more, it has escaped notice by those who are supposed to keep dictionaries abreast of the times.

The basic idea is do what we can, remotely, on the Moon, when human on site labor would be expensive, or dangerous, or best reserved for things which cannot yet be easily remotely performed. What makes teleoperation practical on the Moon, but discouragingly tedious on Mars, is the speed of light that governs remote control by radio. At that speed, there is a bit less than a 3 second delay between a teleoperators "joy stick" movement and the observation of the command being performed. Numerous experiments, many of them by enthusiasts, have shown that this small time delay is manageable. On the other hand, anyone attempting to teleoperate a rover or some other kind of equipment on Mars would have to endure a minimum delay 125 times longer, 6 minutes, and a maximum of around 40 minutes. Ho hum! Zzzzz!

Equipment on Mars, a whole fleet of it in fact, could indeed be easily teleoperated from Phobos or Deimos, but the Mars Society resists the idea of setting up forward outposts on either Mars moonlet, as a "detour." That's their problem. Impatience always bites one in the but, one reason the opening of Mars must be more broadly based. But we digress.

Proposals on the table for teleoperations on the Moon

Over fifteen years ago, it was suggested that mini-rovers on the Moon could be "raced" against one another over a prescribed course, the race watched on television, with the contestants paying for the privilege. The idea was to raise money.

More to the point, it has been suggested that equipment placed on the Moon could be tele-controlled to grade and prepare a site for a lunar outpost and once that was in place, the same or additional teleoperated equipment could cover it with regolith shielding, in advance of the arrival of the first moonbase crew. These would be time-consuming tasks for human crews. By tele-performing these operations, the crew would arrive at a Moonbase all set to go.

MMM Theme Issues: The Lunar Economy - Years 1-25 Dec 1986 - Nov 2011

Beyond Site and Outpost Preparation

There will be “too much to do” for the small initial crew right from the outset. Nor will this change when the outpost begins to grow, not even when the first true settlers arrive. It is a truism of all frontiers, that there is always too much to do, that needs being done, than people to do it all. Sending people who are each multi-talented will certainly help. But that will not change the fact that there are only so many hours a day, and that there are limits beyond which driving individuals to put out ever more and more will backfire.

More to the point, there is a question of priorities. Some things are too sensitive and/or too complex to be performed remotely. Hair-trigger responses are needed. On the other hand, there are tasks that are reasonably dangerous to perform, with a high risk of injury, or even death. These considerations give us a basis on which to decide when it is better to teleoperate, and when it is best to have an on site individual perform a task.

Add to that the financial considerations. Each man-hour of work, regardless of the pay scale, performed on the Moon, costs much more than that person's pay. You have to factor in what it cost to send that person to the Moon, maintain him/her there in good health, and to eventually (at least in the early phases of our open-ended presence on the Moon) return the person back to Earth.

It makes even more sense then, to find a way to teleoperate all risky and dangerous jobs, all routine and tedious jobs, and anything else we can do to relieve base personnel of any work we can so that they can get on with doing what only they can do. That way, the outpost, whether it is manned by four or forty or four hundred, can advance more quickly, will get more accomplished, thanks to its ghost army of teleoperators back on Earth.

Yes, we'd all like to see the lunar population to swell quickly to the hundreds, the thousands, maybe someday the hundreds of thousands. Doesn't taking jobs away from real people on location counter that goal? To the contrary, it advances it, because at each stage this pocket of mankind will be more productive, allowing it to grow faster, not just in industrial diversification and export output, but also in numbers. And the extra productivity earned by teleoperations, will make the settlement bottom line more attractive, less a target for budget cutters on Earth. When they arrive, their habitat space will be ready, thanks largely to teleoperated tasks.

What all can we teleoperate?

- Site preparation, grading, road building, excavation, shielding emplacement, repeatable construction and assembly tasks, deploying radio and microwave repeaters, deployment of solar power stations, initial prospecting surveys. (much more, especially in a given time, than Spirit or Opportunity can do), setting charges in road building, gas scavenging, preliminary routine prospecting surveys, lavatube exploration, etc. – i.e., many tasks that need to be done out on the surface, minimizing EVA hours by personnel in space suits.
- Tending agriculture installations, routine watering, weeding harvesting, fertilizing, etc.
- Many factory operations, especially dangerous ones
- Desk work, paper pushing, document processing tasks

The priority should be

- (a) To take care of as many out vac tasks as possible which would be exhausting and cumbersome for people working in space suits, and not without real risk.
- (b) Exploration of subsurface voids – lavatubes.
- (c) Inside operations which carry some danger.
- (d) Routine, repetitive, and boring tasks to the extent that they cannot be automated.
- (e) Utility and air/water treatment routine tasks,
- (f) Routine inspection jobs,
- (g) Some bureaucratic paper work, minimizing the amount of desk work that has to be done on location.

MMM Theme Issues: The Lunar Economy - Years 1-25 Dec 1986 - Nov 2011

(h) When the time comes, the bulk of routine teaching assignments. Again, one must keep in mind, that teleoperations are to prepare for humans to settle in and live comfortable fulfilling lives.

What we can do now

If we succeed in putting together an aggressive Lunar Analog Research Station program, one thing we don't have to do is prove the value of human-robot teams in field exploration. We have already made that point in the Apollo program years. So practicing lunar geology is not a high priority, nor is field exobiology. The M.A.R.S. analog stations have done great work in this area. Again, we've already made that point almost forty years ago.

On the other hand, the Mars people have no need to demonstrate teleoperations skills, as Mars much greater distance, from 125 to 400 times further from Earth than the Moon, makes teleoperation impractical - unless they want to come to their senses and realize how much faster the Martian globe could be explored with fleets of minirover probes teleoperated from just above, from shielded stations on Phobos and/or Deimos.

Teleoperation with a 3 second time delay has been demonstrated many times, but mainly in the "driving" of rovers. More complex tasks such as site preparation and shielding emplacement via teleoperation have not been demonstrated. These are challenges suit-able for college level engineering teams, and the demonstrations could be done at an analog station. What we'd need for terrain, at least in the area where we would be teleoperating is a physical analog of lunar moondust or regolith. The elemental and chemical composition would be irrelevant. The mix of particle sizes and the behavior of the mix in handling would be essential. It would be in NASA's interest to fund creation of such a site, whether a sandy gravel mix native to the area was further transformed to meet the experiment constraints, or whether the faux regolith was prepared elsewhere and trucked in.

Once site preparation and shielding emplacement techniques were demonstrated, we could ramp up the challenges to include road construction and many other chores we'd prefer not to have done by humans in cumbersome spacesuits, exposed to cosmic radiation. Teleoperated exploration of a nearby lavatube would be possible in some of the sites under consideration (Bend, OR; El Mapais National Monument south of Grants, NM, Craters of the Moon National Park in Idaho). But we could run such tests at one or more of those locations whether we had deployed an analog research station nearby or not. We could also try to develop teleoperable greenhouse systems, water recycling systems, ACC; even though we don't need to demonstrate human geology field work, we could demonstrate teleoperation of prospecting probes.

The possibilities are many, and will grow with the complexity of our outpost, and its continued growth.

Teleoperators on Earth

These people, whether unpaid volunteers, or paid assistants, should earn status as "lunar pioneers." For even if they never personally set foot on the Moon, the fruit of their work will be in evidence throughout the area where human settlements spread. <MMM>



THE OUTPOST TRAP

Technologies Needed to Break Free

By Peter Kokh

IV: ISRU, In Situ Resource Utilization

NASA's announced intention is to begin a modest program of ISRU, in the form of oxygen production from the regolith. A major problem with the plan has emerged, however: NASA is designing the Lunar Ascent Module to use fuels that do not include oxygen! Yet oxygen is not only needed for life support, if transported to Low Earth Orbit, it can be used on the next run out to the Moon, saving the major expense of getting oxygen-prefuelled vehicles up from Earth into LEO. We hope that NASA is not dissuaded from going ahead with its modest and limited ISRU project, however, as it will be just the beginning, the first step in using "on location" [Latin "in situ"] resources.

First, the basics

We need to begin with basics, such as **cast basalt** and **sintered iron fines collected with a magnet**. These can provide abrasion-resistant chutes and pipes and other items for handling regolith, and low performance metal parts respectively. Then we can handle regolith more effectively to feed additional ISRU projects.

Composite Building & Manufacturing Materials

Long before we can produce iron, aluminum, magnesium, titanium and workable alloy ingredients, we can make useful building materials out of raw regolith and minimally enhanced regolith. processing elements and building materials from the regolith. Using highland regolith with a higher melting point to produce **glass fibers**, and mare regolith with a lower melting point to produce **glass matrix** material, we can produce glass-glass composites on the analogy of fiber reinforced resins (fiberglass). But to make this work we need to bring down the melting point of the mare glass matrix material further by enriching it with sodium and potassium. (A study funded by Space Studies Institute recommended the expensive import of lead as a temperature-reducing dopant!) This gives us an **action item**: isolating sodium and potassium, or sodium and potassium rich minerals.

If we can also isolate sulfur, we can experiment (and yes, why not here and now?) with fiberglass-reinforced **sulfur matrix** composites. Simpler yet, we can make many low-performance household items from "dishes" to planters to table tops and floor tiles from crude **raw glass** and **cast basalt**, no processing needed other than some sifting.

We will bet that glass composites, sulfur composites, cast basalt, and raw basalt glass will all find profitable terrestrial applications which may make the predevelopment of these technologies attractive to entrepreneurs, thus putting at least a close analog of technologies needed on the Moon, "on the shelf," in a reverse of the usual "spin-off" sequence. We call this "Spin-up."

Metal Alloys

Using ilmenite (we can now map ilmenite-rich mare deposits on the moon) we can use this **iron, oxygen** and **titanium** mineral to produce all three elements. It is **the first ISRU Suite** to be identified. We need to identify more. Lunans will not live by oxygen alone!

Aluminum, abundant though it is, might be the hardest to produce, magnesium, somewhere in between. The catch is that for all four of these "engineering metals" the elements we regularly combine them with in order to produce workable alloys are rare on the Moon. For iron and steel we need carbon. For aluminum we need copper, and to a lesser extent zinc.

MMM Theme Issues: The Lunar Economy - Years 1-25 Dec 1986 - Nov 2011

The action item here is for **metallurgists down here on Earth** to dust off old alloy experiment records. Some pathways, while doable, promised less superior results, and may have been abandoned. If they involved alloy ingredients that are economically producible on the Moon, we may have no choice but to go down that route to see where it leads. We need to do **research now** on lunar-feasible alloys that will perform in a “second-best” manner. Second best is better than nothing.

At a minimum, we need to be able to isolate, or produce, not only the four engineering metals, present on the Moon in parts per hundred, but all the elements present in parts per 10,000. See middle square below

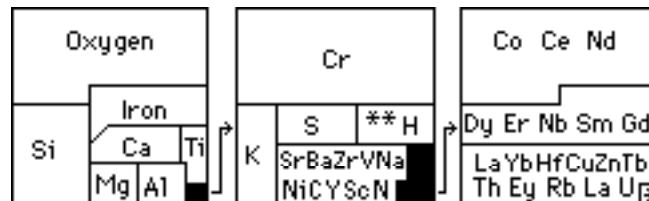

Read: “Beneficiation” MMM #63, republished in MMM Classic #7,

http://www.moonsociety.org/publications/mmm_classics/mmmc7_Jan2006.pdf

Agricultural Fertilizers

From past NASA experiments with the Apollo Moon samples, we know that regolith has about half of the nutrients needed for healthy plant growth. Using **gas scavenging equipment** on board all earth moving vehicles (road construction, shielding emplacement, material for processing and manufacturing) we can use the harvested carbon and nitrogen and hydrogen to make fertilizer supplements. Potassium we will find in KREEP-rich deposits around the Mare Imbrium rim. Other elements hard to produce on the Moon can be used to manufacture cannibalizable shipping containers and packaging materials, to “stow away” on a ride to the Moon.

Let there be color!

Combine humidity, likely to be higher in pressurized habitat spaces, with the iron fines in regolith and we get rust for a splash of color. Titanium dioxide produced from ilmenite will give us white. Combine rust and white and we get a pink. Black, many gray shades, white, rust and pink. The rest will be harder. **Metal oxide pigments will be a secondary goal** in our processing experiments.

Using the Slag and Tailings

Slag and Tailings are in themselves “beneficiated” stuffs from which we can probably make many low performance household items and construction elements. Doing so will reduce the “throughput” of our young lunar industrial complex. By treating these byproducts as resources rather than as waste (“wasources”) we reuse the energy that was used to form them. This will work to greatly reduce what the settlement “throws away” – the goal being “nothing!”

Export Potential

Killing two birds with one stone has always been a desirable strategy. ISRU products from oxygen to metal alloy and non-alloy building and manufacturing materials will reduce the need for expensive imports as Lunan pioneers learn to make more of the things they need to expand their settlement and outfit it in a livable manner.

But for long-term economic survival it is essential to go beyond reducing imports. There will always be some things the settlement is no large enough, and its industries not sufficiently diversified to produce. There is a need to pay these imports. We cannot rely on any long-suffering generosity of terrestrial taxpayers. We can pay for our imports with credits from exports. Now in addition to proposed energy exports, and various zero-mass exports ranging from communications relays to broad-casting unique lunar sporting (and dance) events to licensing technologies developed on the Moon, there is an area of real material exports.

MMM Theme Issues: The Lunar Economy - Years 1-25 Dec 1986 - Nov 2011

As long as one thinks of Earth as the Moon's only trading partner, this prospect seems outrageous. Shipping cost would make lunar products very expensive. On the contrary, it is shipping costs that will be the settlers' trump card, if there are other markets developing side by side in space. For example, while lunar building and construction materials and outfitting products may seem crude and unrefined to us on Earth, if they do the job, we can deliver them to low Earth orbit commercial space stations, orbiting industrial complexes, and orbiting tourist hotel complexes at a definite advantage over any competitive product that has to be boosted up from Earth's surface. It's not the distance, but the gravity well difference. For any product we make, as far as in space markets go, Earth will not be able to compete.

We have to think of the future economy as including not just Earth and the Moon, but other areas in nearby space that will become areas of human activity. This market will continue to work to the advantage of the rapidly diversifying lunar economy and growing lunar population as the population in orbit continues to grow, and as Mars begins to open up. It can only get better. But ISRU, not just of oxygen, but of many elements is the key.

ISRU and Rare Elements on the Moon

Dennis Wingo, in his recent book **Moonrush**, sees the Moon as a potential source for platinum needed for fuel cells to make the forecast Hydrogen Economy work. None of the samples returned by the six Apollo landing missions and the two Soviet Lunakhods showed this element to be present in parts per billion. Now you can say that we only sampled eight sites. Not quite true when you consider that at any given location on the Moon, only half the material is native, the other half having arrived as ejecta from impacts elsewhere on the Moon. In that sense the areas of the Moon samples are somewhat representative. Wingo argues that platinum-bearing asteroids had to have bombarded the Moon. We do not quarrel with that. But it is likely that the infinitesimal smithereens are scattered all over the place with no enriched concentrations anywhere. Now we'd be happy to be proven wrong.

Geologist Stephen Gillett, University of Nevada-Reno, and an expert on lunar geology, now thinks that the way to beneficiate (increase the concentration of) scarce elements is to feed regolith to bacteria in vat cultures, the bacteria having been bioengineered to feed preferably on given elements.

Dr. Peter Schubert of Packer Engineering in Naperville, Illinois outside Chicago, has developed an on-paper process, patents pending, that would use shoot regolith into a 50,000 degree (C or F?) laser beam and separate out the various elements and isotopes and direct them to separate catching containers. This is, of course, the ISRU process to end all ISRU processes. We are not qualified to estimate what is involved in development of a working demonstrator, or at what scales this process would operate most efficiently. It does seem to require a considerable energy input, perhaps from solar concentrators. It offers a glimpse of the future, when lunar settlements are shipping megatons of sorted elements for construction projects in space. (L5 revisited.)

Summing Up

- We cannot thrive on oxygen production alone! We need to concentrate on other ISRU goals, especially **ISRU Suites** or Cascades in which more than one element results.
- We need to enable with **research now**, early industries that fill needs and defray imports – Building, Construction and Manufacturing materials
- We need better, **higher resolution global lunar maps**, that show not just where we will find regolith enriched in iron, calcium, thorium, and KREEP (what we have now, at least at poor resolution.) We need orbiting instruments to indicate the richest concentrations of other elements we will surely need. Action item: suggest to NASA in detail, the kind of instruments it should fly on planned orbiters.
- As this information comes in, keep **reducing the long list of settlement locations to a short list**. What we have noted already, demands, If we truly want lunar industries and industry-based settlement, to look elsewhere than the highland-locked poles. What we

MMM Theme Issues: The Lunar Economy - Years 1-25 Dec 1986 - Nov 2011

need is a Highland Mare Coast, near ilmenite and KREEP deposits. That would give us access to all the major and most of the lesser abundant elements present on the Moon. But we may have to establish a number of settlements, each in differently endowed locations. After all, one settlement does not make a world!

- We must **research reuse options** for pre-beneficiated tailings as building materials with lesser performance constraints. On Earth, there is no shortage of abandoned piles of tailings with which to experiment. Entrepreneurs, like artists, love free materials.
- Many experiments are possible with **obvious terrestrial applications** which may prove profitable.
- We need an **organizational machine** that will
 - ✓ Work to identify all these research needs and
 - ✓ Attract effective attention to them,
 - ✓ Serving as a catalyst to get the work done.
- The goal, if we choose to accept this mission, is to return to the Moon, ready to start building out the first resource-using settlement, so that the NASA Outpost can do science for a while, then retire to become an historic lunar national park site. In short, our goal is “Escape from the NASA Outpost” – returning to the Moon with the tools needed to avoid the “Outpost Trap.” <MMM>

V: Industrial Diversification Enablers

1. Accepting the dayspan–nightspan energy challenge

It is not enough to develop the technologies needed to turn on location resources into products for domestic use and export. We have a little quirk in the way the Moon does its own business, rotating in and out of sunlight every lunar “day” that presents a considerable challenge. The Moon’s “day” is almost 30 times as long as the one we are used to.

The challenge is to find ways to store up as much energy as we can during the 14.75 Earth days long dayspan as potential energy, to keep us running on a lower but still productive level through the 14.75 Earth days long nightspan.

Yes, that’s why so many lunar advocates are drawn like moths to the eternal sunshine of very limited and rugged areas at the Moon’s poles. But if you read the last two pages, you will know that except for water ice, the resources needed to build an industrial lunar civilization lay elsewhere. We will have to ship the ice to the settlements just as we ship the oil from Alaska’s north coast to California.

There is no way to avoid taking on the dayspan–nightspan challenge. Turn aside from the challenge and we may be limited forever to tiny ghettos’ at the lunar poles. Accept and win the challenge, and the Moon is ours, all of it.

The options for dayspan storage of energy to use during nightspan are treated in other articles. See: MMM # 126 JUNE ‘99, p 3. POTENTIATION: A Strategy for Getting through the Nightspan on the Moon’s Own Terms – This article has been republished in MMM Classics #13 http://www.moonsociety.org/publications/mmm_classics/mmmc13_July2006.pdf

2. Accepting the reduced nightspan power challenge

We might think of the pioneers waiting out the two–week long nightspan playing cards, writing their memoirs by candlelight, and making love for want of something else to do. But if we successfully meet the dayspan power storage problem, the pioneers will have enough energy to continue being productive by focusing and concentrating on less energy intensive and perhaps more manpower intensive tasks and chores, leaving manpower light and energy intensive processes for the dayspan. Inventory, scheduled maintenance, product finishing, packaging and shipping, etc.

The challenge is to take every operation and sort it into the two kinds of tasks or steps stated above. Not every industry is going to lend itself easily to an equal “division of scheduled

MMM Theme Issues: The Lunar Economy - Years 1-25 Dec 1986 - Nov 2011

labor.” Some will need more man-hours during the dayspan and have few assignments to keep as many people busy during dayspan. Other industries may present the opposite situation. One can see arrangements where some employees work for company A during the dayspan and company B during nightspan.

Can we come to a plan whereby everything evens out and everyone is kept busy all “sunth?” (the Sun appears to revolve around the Moon once every 29.53 days, whereas the Earth does not, i.e. sunrise to sunrise marks the period we know as new moon to new moon, “month” for us, “sunth” for them. I digress. We have stated an ideal a lot of trial and error and the steadily increasing diversification of lunar industry predicts an ever-shifting employment situation. Our purpose is to suggest the process management research that we need to undertake now, industry by industry, business by business if we are to have any hope of making ourselves “at home” in the lunar dayspan-nightspace cycle. At stake is the success of lunar industrial diversification, and the competitive market cost of lunar export products.

3. Accepting the radiation challenge

“The Moon is a Harsh Mistress,” blares the title of one of Robert A. Heinlein’s best-known science-fiction novels. Part of that harshness comes from seasonal solar flares of great intensity. Part of it comes from incessant cosmic radiation from all quadrants of the sky. Part of it comes from the Moon plowing through space rivers of meteoritic dust left behind by comets.

All of these dangers call for shielding. The most used lunar resource of all is going to be plain regolith, piled up above habitation and working spaces, directly, or indirectly, that is over hanger-type frames with habitat structures and vehicles safely inside.

We understand the challenge, and the many options. We are prepared to meet the challenge for people in place. But what about for people in transit? A solar flare can hit the Moon with insufficient warning to allow vehicles more than a few minutes from base to return in time.

We need to give attention to the architecture and building systems to deploy at the least expense, effective wayside flare shelters at regular intervals along roadways. Whether they are lightly or heavily traveled makes a difference not in the spacing and number of shelters, but in how capacious or large such shelters are.

The Moon, like any new frontier will remain hostile and unforgiving only until we have mastered the ways of dealing with the new environment as if by second nature. The need to quite literally cover our butts from the rare but hard to predict solar flare is one we must take seriously. Lunar industry must anticipate this need.

Working out-vac in spacesuits will be cumbersome and tiring. For routine tasks such as accessing out-vac utility systems or outside storage items needed on a regular basis, it would make sense to place all these items under a shielded unpressurized hanger, shed, or canopy. Then a lightweight pressure suit will do, and that will greatly reduce stress, fatigue, and discomfort. The architectural systems for this everyday out-vac shelter system are the same as those needed in the event of solar flares. We can meet this need now by university-level architectural and engineering competitions, with ease of deployment and of shielding emplacement above the frame all being part of the challenge.

4. First industries first

It will be a challenge in itself, just to decide which industries to deploy first and just which of many possible paths lunar industrial diversification will take. As in picking a college course, one has to give attention to “prerequisite” courses. Likewise, some industries presuppose others in place beforehand, and in turn enable yet additional industries. Some industries will be viable only if developed side by side, step by step. Now there’s a doctoral thesis for someone!

We make no pretense of being able to sketch such a tree of industrial ancestors and descendants, but would like to start with some notes about what we need to break out of the Outpost Trap. Rather than repeat, we ask the reader to take a second look at MMM # 91 Dec. 1995 p 4. “Start Up Industries on the Moon” – reprinted in MMM Classic #10, a free download

MMM Theme Issues: The Lunar Economy - Years 1-25 Dec 1986 - Nov 2011

pdf file at the sites listed above. Also MMM # 191 DEC. 2005, p 7. First Lunar Manufacturing Industries – available as a Moon Society username/password accessed directory of recent MMM pdf files; www.moonsociety.org/members/mmm/

But, first things first!

- Regolith bagging and other regolith shielding systems enhanced
- Prioritization of fabrication of furnishings and outfitting needs for inflatable modules
- Using those same industries to fabricate things for residential quarters.
- Some early art and craft media to make ourselves feel at home with art expressed in native materials

5. One Size does not fit all

In last month's installment, MMM #198 page 4, "Modular Transportation" and following, we mentioned that importing modular factory pods and utility pods made sense. That said, a system that works on that scale, say a trailer for a Semi Tractor, may not be the best choice for a smaller installation, nor for a settlement that had grown considerably. We need to base our judgment of system efficiencies and production on scale-dependent guidelines. For a tabletop demonstration, one ISRU device may work fine, but fail utterly on a much larger scale, and vice versa.

6. Attitude is the make-or-break ingredient

If your way of operating causes a problem, you are unlikely to contribute to a solution. At every stage of human advancement, there have been shingle-qualified experts who have said this or that could not be done. A favorite trick in teaching students how to handle such situations is to ask them to jot down all the reasons such and such is impossible to achieve, and then, after they have done so, give them a second assignment: "Now right down all the reasons why we are going to do it anyway."

We have to bypass stuck-in-the present experts and luck for "Young Turks" with an open and aggressively adventurous curiosity, determined to find workarounds and new pathways where none were suspected before.

The Moon will be one hard nut to crack. I am sure a human ancestor in Africa a hundred thousand years ago, suddenly transported to the northern coast of Greenland would have thought the same thing. But we did crack that nut. The Inuit and Eskimo take living under such conditions for granted. They handle the challenges that would be life-threatening to us by second nature.

If we get raised eyebrows along the way, "industrializing the Moon, are you?" let those raised eyebrows encourage us all the more. The epic sweep of the human saga from Africa to continents beyond the shores of their home continent/world runs through our veins. We will do this, because we are humans. And as before, we will become even more human in the doing of it. For the challenge of settling the Moon will bring out new capacities in us, capacities we did not know we had, because we were never challenged before to rise to occasions such as lay before us.

VI: The Entrepreneurs

1. Launch vehicles, Modules, Services

We are used to thinking of "space entrepreneurs" as involved with startup launch companies. Certainly, those are the most visible. Right now, the markets for enterprise involvement are still few, but the pace of new starts is picking up. NASA is one of the forces involved, determined to replace the Shuttle with Commercial launch companies serving the ISS with cargo and personnel transfers. The agency is also trying to find minor roles for private service providers in the return to the Moon and establishment of a small science outpost.

As the International Space Station and possible other orbital facilities grow and multiply, the market for various kinds of enterprises providing logistics services will grow with it.

2. Space Tourism

MMM Theme Issues: The Lunar Economy - Years 1-25 Dec 1986 - Nov 2011

But the real glamor is in the infant space tourist industry. Here entrepreneurs are involved in providing man-rated launch vehicles, vehicle operation services (Virgin Galactic), and space destinations (Bigelow Aerospace.) This entrepreneurial area promises to grow continually, with not just orbit in mind, but non-landing loop-the-Moon excursions. Before the first of those, possibly within the next two years, some will start planning how to offer self-contained moon landing sorties.

Some dismiss tourism as a driver. This is a mistake. Discretionary income is rising, and worldwide, tourism is near the top in income-earning sectors. We have believed, that failing a viable Moon-based energy production effort, tourism alone has the capacity to open the Moon.

Read MMM #161, Dec. 2002, pp. 4-5 "Tourist Clusters on the Moon" reprinted pp. 3 ff. in http://www.moonsociety.org/publications/mmm_classics/mmmc17_July2007.pdf

3. Making Money by Laying Foundations

Stating way back in July, 1988, in MMM #16, we began describing a way of doing business that turns "spin-off" on its head. Instead of NASA doing an expensive crash R&D technology project at the expense of unwilling taxpayers, then, later making the technology available free to enterprises, a would-be entrepreneur looks at the technologies NASA needs (or that we need to go beyond NASA and break out of the Outpost Trap) and brainstorms them for potentially profitable terrestrial applications, creates a business plan, and goes ahead with the needed R&D to be ultimately reimbursed by willing consumers, precisely for those identified terrestrial applications. In the process, a technology needed on the frontier, or a close analog thereof, gets put "on the shelf" free of charge to taxpayers.

We have talked about a number of technologies in need of R&D, and the way to get this done in a timely fashion is not a taxpayer-paid crash program, but by a spin-up enterprise. The options are too many to number, indeed to many to imagine.

So how do we connect potential entrepreneurs in search of a business idea/plan with our laundry list? That is the question, and in a month or two we hope to give you the start of an answer, involving a meta/mega project that will subsume and interrelate all other Moon Society projects and keep us on course on the path to a viable lunar settlement civilization.

VII: Moonbase Personnel

The most critical moonbase system to success is the human one

There have been many Human Factors Research studies done at the two Mars Analog Research Stations to date, but they all suffer from involving short crew stays. Most anyone can put up with anything for two weeks. Studies aboard submarines and at Antarctic stations are more helpful, but still do not mirror conditions we will find on the Moon and Mars.

Many ordinary human activities, are not modeled because they can be postponed. This includes exercise, sport, many kinds of recreational activities, get-away-from-it-all options, indulging artistic abilities, etc.

A more thorough investigative approach should give clues as to which type of modules and facilities, and the activities that they will enable, should be added, and in what priority. At stake is general crew morale, productivity, and safety as well as general health.

That said, NASA's purposes and our purposes are at loggerheads. NASA would indefinitely man a lunar outpost with crews being regularly rotated, barring events unforeseen. Our goal of breaking out of the outpost trap towards settlement, means finding ways to encourage personnel to willingly re-up, stay for "another tour" without limit, so long as health of the individual and of the crew at large is not an issue. That means providing the kind of perks that:

- Increase morale and improve performance
- Promote willingness to re-up so as to give the weight allowance for his not-needed replacement to valuable imports of materials and equipment, especially tools and equipment to fabricate and experiment

MMM Theme Issues: The Lunar Economy - Years 1-25 Dec 1986 - Nov 2011

- Create a plan for outpost expansion of modules, the facilities they house and activities they enable

Providing for a full range of human activities:

- Getaway “change of scenery” spaces and out-places
- A range of customizing options for personal quarters
- Menu diversity and variety, including fresh salad stuffs and vegetables on occasion
- Schedule breaks (take advantage of the dayspan/nightspace cycle for regular changes of pace such as alternating types of work and recreation)
- Allow fraternization between crew members, without harassment, of course
- Promote expression of artistic and craftsman instincts using local materials and media
- Experiment with lunar sports and other recreational activities. Lunar-unique sports and performing arts – are things that make crew begin to “feel at home”.
- Out-vac sport & recreation on the surface
- An indulgent spa and an exercise gym
- Telecasts to Earth of everything unique and special
- “While you are here” opportunities for excursion exploration and “tourist” experienced and memories

All this both presupposes and prepares for an orderly expansion beyond the original functional and space limits of the original outpost. But that’s what we need to do to “breakout of the Outpost Trap.” <MMM>

MMM # 200 November 2006



THE OUTPOST TRAP

Technologies Needed to Break Free Continued from MMM #198 & 199

By Peter Kokh

VIII: Strategies for Organizations self-tasked with helping make it happen Many have heeded the call

Several organizations have appeared over the years who have taken upon themselves to help advance the day when space settlement, and lunar settlement in particular, might become a reality. Space Studies Institute, the former L5 Society, the Space Frontier Foundation, Artemis Society International, The Mars Society, The Mars Foundation, The Moon Society, and the National Space Society have pursued these goals on the national and international level. NSS, however, has traditionally limited its set of tools to political, public, and media outreach.

On a smaller scale the Lunar Reclamation Society (publishers of Moon Miners’ Manifesto), the Oregon L5 Society, and Calgary Space Workers have done, and still continue to do what they could to lay foundations. Other outfits have come tried for a while, only to disappear.

“Nature abhors a vacuum”

MMM Theme Issues: The Lunar Economy - Years 1-25 Dec 1986 - Nov 2011

The premise on the table is that NASA, most probably with international partners, will establish a minimal outpost on the Moon. Several successions of the US Administration and Congress will have to go along with these plans and that makes these plans and announced intentions and commitments highly contingent and “iffy.” Further, as individuals and organizations, we will have very limited ability to influence these critical decisions.

But even if all goes as planned, an international lunar outpost will fall far short of establishing a permanent civilian presence on the Moon. Permanence cannot simply be declared. It has to be earned.

Room for the rest of us to rise to the occasion

What we can do, is to work to see that the needed technologies are in place to enable a “breakout” from any such limited scope outpost, in the direction of resource-using open-ended civilian settlement.

We have looked at several general areas in which a lot of work needs to be done:

- Pushing the Teleoperations Envelope
- Shielding Emplacement Systems
- Warehousing Systems
- Modular Biological Life Support Systems
- Dayspan power storage Systems for Nightspan use
- Modular Architecture & Construction Systems
- Transportation Systems, to, and on the Moon

Tools at our disposal in seeking to further these goals

- **Brainstorming workshops** – We gather those at the forefront of experimentation in a given field, ask each to list (a) what we know, and (b) what we don’t know. Combining these surveys, the workshop decides on the most promising areas for collaborative research and experimentation.
- **Design contests** – many things are in need of having design options fleshed out: shielding emplacement systems; shielded but unpressurized canopies and hangers; modular architectural languages; the list is long
- **Engineering competitions** – shielding emplacement systems vie to demonstrate trouble free operation, speed, efficiency, etc.; various options for storing excess dayspan solar power for nightspan usage; interfaces between connected modules, the list is long
- **Talent recruitment** – our collective memberships do boast some people of real expertise and talent, perhaps lost in an abundance of well-intentioned lay persons. We definitely need to recruit talented people in all areas of science and technology, architecture, systems management, biological life support, lunar agriculture, and in many more areas
- **Moonbase analog stations** as equipped settings for demonstrations of candidate technologies. Various types of sites offer advantages for various types of demonstrations: lava sheet areas perhaps with handy lavatubes; any low vegetation pulverized surface area for demonstrations in which the physical attributes of lunar regolith are more relevant than the mineralogical and/or chemical ones: enclosed lighting-controlled environments where dayspan-nightspan operations can be simulated; almost any location where biological life support and food production systems can be demonstrated
- **Lunarpedia** – a dedicated lunar-relevant wikipedia which will attract quality articles about the nature of the Moon, its resources, and the possibilities for integrating the Moon into a Greater Earth-Moon economy, and the possibilities for those involved to make themselves at home.
- **Early astronomical facilities on the Moon** – we can promote design contests, engineering competitions, and the creation of university consortia in support of such a “foot in the door.”

MMM Theme Issues: The Lunar Economy - Years 1-25 Dec 1986 - Nov 2011

- **Citizen Exploration, aka tourism** – Loop-the-Moon tours are closer than most imagine. Beyond that, the first limited land and take off again tourist missions could conceivably occur before the deployment of the first agency outpost. Such a development will create a precedent for a truly permanent civilian presence on the Moon not limited to one station.
- **Spin-up Enterprise incubation** – draft business plans entrepreneurs could use to develop needed technologies, now, for their profitable terrestrial applications

Marching Orders for whichever organizations choose to step up to the plate

This becomes the strategy for the Moon Society, and its affiliate and partner organizations. It will come to define “who we are” and “what we do.” What we must do!

In the near future, we hope to announce a “meta-project” that will subsume all of the above and keep everything headed towards our goals. It will have the power to become a catalyst for the needed research and development, a “research & development engine” if you will. Stay tuned.

MMM

IX: A Lunar Analog Station Program can pave the way, if well-focused

By Peter Kokh, David Dunlop*, Michael Bakk**

* Moon Society Director of Project Development

** Captain of the Calgary Space Workers who are developing the prototype modular analog outpost

[Our 3rd attempt at unzipping the L.U.N.A. Acronym]

“Luna Underground Nucleus Analog”

“**Lunar Underground**” – **That’s us**, an underground movement! Plus we will model **shielding**, shielding architectures and shielding emplacement options as well as monitor the thermal equilibrium benefits of an “underground” (under a regolith blanket) facility.

“**Nucleus**” – we are modeling not a self-contained unitary module good only for extended science picnics but the kind of modular outpost that could become the nucleus of open-end expansion into a civilian, industrial settlement

“**Analog**” – we aren’t trying to be exact. We need to pick our battles, getting the most bang for the buck.

We had tried twice before to come with an unzipped “Luna” acronym. Most recently, in MMM # 194 April ‘06 we suggested ‘Lunar Underground Network Accelerator.’ In MMM #148 Sept ‘01, “Lunar Utilization & Necessities Analog.” We like the new reading best.

A Summary of where we are at in our planning

As stated in the MMM #195 article cited above, an analysis of research & development demonstration needs shows that the Goals of a Lunar Analog Station are quite different than those of the various Mars Analog Stations:

- We do not need to demonstrate the usefulness of human exploration of the Moon. Apollo did that well.
- We will not be demonstrating microbiological forensic techniques that might prove the Moon once had or might still have living microorganisms – we are all amply convinced by the Apollo and other evidence that the Moon is totally sterile
- Nor do we have to demonstrate geological techniques that might reveal the scope of Mars once much “wetter” past – the evidence that the Moon has always been bone dry is overwhelming.
- We don’t have to model a first visiting crew exploration vehicle. NASA began that with Apollo and will continue that with the lunar outpost program

What’s left for us to do?

- ✓ NASA’s plan was limited from the outset
- ✓ It is vulnerable to budget cutbacks

MMM Theme Issues: The Lunar Economy - Years 1-25 Dec 1986 - Nov 2011

NASA's plan is for a small crew outpost with limited capacities for growth and to support demonstrations of production of various elements and of lunar appropriate building materials. The agency's plans are very vulnerable to unrelated budgetary pressures, owing to the black hole of conducting an unforeseen war.

Biological Life Support Research has just been cut

Already NASA has discontinued the BioPlex project in Houston and stopped continued funding for the NSCORT program at Purdue University. Both of these programs were aimed at finding practical ways to deploy closed loop life support systems supported by plant growth and food production and waste treatment systems. There is no question in anyone's mind that a permanent presence, let alone true settlement, can be realistically supported on the Moon without coming very close to "closing the loop."

This means that it is up to efforts outside NASA to make continued progress in this area. Actually, the NASA plan was so limited from the outset, that it has always been up to us.

You can't do biological life support in an add-on closet. Life support cannot be approached as an afterthought. It has to be designed into every module and connecting corridor.

We will be studying the modular habitat prototype being designed and built in Calgary, Alberta, and to be deployed in the Drumheller, Alberta badlands, looking for opportunities to integrate biological life support functions. Biospherics must be approached in a modular fashion, so that as the pressurized interconnected habitat complex grows, the biosphere will grow with it, hand in glove, step by step. If you are designing a limited outpost with expansion as an afterthought, such an architecture will seem irrelevant, or not worth the cost.

Shielding cannot be an afterthought

Many NASA illustrations pay homage to Bob Zubrin's double tuna-can design, become so familiar to all of us as the architecture of the Arctic and Desert Mars Research Stations in Canada and Utah. The high vertical profile makes shielding difficult. Zubrin seems to dismiss radiation shielding as unnecessary. But if we are going to move beyond short tours of duty towards real permanence, we have to rely on more than Release Statements that do not hold NASA responsible for radiation damage.

Unaddressed are the major thermal equilibrium benefits of shielding. It pays to design an outpost in a "ranch style" low profile format to make deployment of regolith shielding easier. Shielding can be deployed directly as loose regolith, or as bagged or sintered regolith (blocks) for easy removal should access to the hull or a need for expansion make it necessary. We need to experiment with teleoperated shielding deployment systems, so that a landed but unoccupied outpost can be pre-shielded and ready for occupancy by the first crew. We can demonstrate a variety of such systems.

Modular Architecture, Shielding, and the Media

Granted, the Zubrin double tuna can (DTC) design has been a big hit with the press. It looks like the other-worldly mechanical "visitor" that it is. On the other hand, it does not look like "module one" of a future settlement, and that is the concept that what we want the public and the media to grasp. We must sell modularity. On the surface, that will be an easy task. But if we use reconditioned travel trailers and other adapted but identifiable terrestrial artifacts, that appearance may detract and distract from the lesson we are trying to get across.

However, if we shield the complex with simulated regolith, sand bags, or bags of mulch, whichever is more practical, we'll get our lesson across. A shielded modular complex will look much more serious than the DTC. The idea that we are planning to stay on the Moon, not just explore it and go back home, will be clear. We can make show how the shielding blanket on the Moon will perform the same services for us as does our atmosphere blanket. That we can make ourselves at home on what looks like an inhospitable world will begin to sink in. Daydreams of being stationed in a livable lunar outpost will start to look more romantic than being confined to a DTC on Mars.

MMM Theme Issues: The Lunar Economy - Years 1-25 Dec 1986 - Nov 2011

Resource use should not be an afterthought

The well-advertised NASA In Situ [on location] Resource Use demonstration of oxygen production is still on the Lunar Outpost manifest. But by deciding that lunar oxygen would not be used for the lunar ascent vehicles, NASA effectively put it on the budgetary chopping block.

Lunans will not live, let alone thrive, by oxygen alone!

A lunar analog research station in basaltic terrain could get involved in cast basalt use demonstrations. Cast basalt tiles and abrasion resistant materials handling components are now being produced in several locations. If there is anything that is priority #1 it is to test regolith handling systems, and if we need cast basalt products for that, that fact would but cast basalt demonstrations ahead of everything else, perhaps even ahead of oxygen, as all other ISRU experiments will depend on regolith handling. Cast basalt products can replace many original outfitting items in the habitat module complex: flooring: table, desk, counter, cabinet tops, wall tiles, decorative items and objets d'art.

Other building materials to experiment with are glass-glass composites (currently just one ice-cube sized laboratory sample), steamed fiberglass cements, fiber-glass-sulfur composites, sintered regolith products, sintered iron fines products, sintered regolith products. The first goal will be to be able to demonstrate the feasibility of local (on the Moon) outfitting of inflatable expansion modules. Demonstration of the production of pressurizable modules from simulated lunar building and manufacturing materials would come next.

Experimentation with lunar sourceable metal alloys, as critical as it is, is best done elsewhere, because of project complexity and thermal conditions, and the expertise needed. In all these ISRU experiments, we must keep in mind that laboratory scale experiments, however successful, do not prove that production-scale operations are feasible. Chemical engineers will be much more help-full than chemists, for example. Laboratory scale experiments done elsewhere can possibly be demonstrated on a larger scale at analog facilities.

Power Production & Storage

NASA and many lunar enthusiasts are hellbent on setting up shop at the lunar south pole. To quote lunar planetary scientist Paul Spudis,

“Although polar ice is important, it is not a requirement to successfully live and work on the Moon. The poles of Moon are primarily attractive due to the near-permanent sunlight found in several areas. Such lighting is significant from two perspectives. First, it provides a constant source of clean power and allows humans to live on the Moon without having to survive the two-week-long lunar night experienced on the equator and at mid-latitudes. Second, because these areas are illuminated by the Sun at grazing angles of incidence, the surface never gets very hot or very cold. Sunlit areas near the poles are a benign thermal environment, with an estimated temperature of about $-50^{\circ} \pm 10^{\circ}\text{C}$.” -

<http://www.thespacereview.com/article/740/2>

Now if you are younger than fifty, the expression “Kilroy was here,” may mean nothing. This was a WW II (and perhaps older) way of “tagging” a place to say that a Yankee (an American) had been there. Now if all that you need to die happy is to know that we put up a “Kilroy was here” outpost at the Moon’s south pole, than Spudis’ vision will thrill you to the core.

But if by “lunar settlement” you mean a global presence of humanity on the Moon, then the lunar polar “gesture” (which is all it is) will be but “a tagging event.”

Avoiding the Nightspan Power Problem and the Dayspan Heat Problem is exactly what we must not do!

As NASA has chosen not to bite this bullet, demonstrating various ways that enough excess lunar solar dayspan power can be stored to get us productively through the nightspan is a priority task for Lunar Analog Stations. That said, simulating the 14 day 18 hour long dayspan and same length nightspan will be much easier to do inside a closable structure such as a large

MMM Theme Issues: The Lunar Economy - Years 1-25 Dec 1986 - Nov 2011

aircraft hanger or high-ceiling warehouse than anywhere outdoors. For this kind of experimentation and demonstration the geological and/or physical characteristics of the host terrain will be irrelevant.

Power storage options include storing waste water at a usable head height, flywheels, fuel cells, magma pools, and other devices. Yes, a nuke would do, but we think it is important to demonstrate any other non-nuclear “backup” options that would do the trick, and which would be easier to scale up or down to the power requirements of a growing lunar beachhead.

The other half of the equation is demonstration of how well various types of lunar outpost operations can be managed sequentially to take care of the bulk of energy-intensive operations during the dayspan, and the bulk of labor-intensive energy-light operations during the nightspan. Such a regular change-of-pace rhythm is bound to become a welcome mainstay of lunar culture.

Ergonomics Demonstrations

The Mars Society missed an obvious opportunity for an ergonomics layout study, by outfitting the interior of its second habitat, the Mars Desert Research Station, with essentially the same floor plans, upper and lower, as in the Arctic station which was built first. Of course, there were time and money benefits to taking a bye on the ergonomics opportunity.

The independent-minded European Mars Society will be designing the interior of the EuroMars with a clean slate. They are happily immune to the expected criticism. This unit will be just a tad taller, by just enough to squeeze in a third floor. They will be incorporating more opportunities for customization of personal quarters, euphemistically called “staterooms” as well as morale boosting perks like a spa tub, and exercise area. The objection that pioneers should feel privileged to “rough it” just doesn’t cut it. High morale translates to productivity and safety, and those are far more important considerations than penny pinching economy. One must keep in mind that the Mars explorers will be away from home for two or three years, factoring in the long travel times to and fro.

A modular outpost gives much more opportunity to vary living and working arrangements and their mutual proximity or isolation. A modular outpost, particularly a “practice” one, can have its layout plan “shuffled and reshuffled” until the happiest disposition is found. A consideration, one that does not easily arise in the Mars Hab instances, is finding the best vectors for expansion of the various kinds of facilities: residential, energy generation, workshop, laboratory, fabrication shop, greenhouses, exercise and recreation facilities, and whatever other modular facilities may be needed to “break out of the outpost trap.” Developing a site plan with options for expansion must be part of the site selection process.

A mix of hard body and inflatable modules will also yield valuable lessons. The option of adding new modules fabricated out of simulated lunar-processed building materials such as glass composites or fiberglass reinforced concrete is also attractive.

Lunar Analog Outposts will be innovative

It may seem to the casual observer in the public or the media that the exercises at the two operational Mars Habs are getting repetitious. Until you take a close look, all the geology experiments, the biology experiments, the GreenHab experiments, and the human factors studies seem to produce nothing new. Take it from one who has been on two MDRS crews: that is definitely not the case. New things are being learned crew after crew, and I remain a staunch supporter of the Mars Analog program. But the illusion or repetition dogs the program.

Next year, there will be a 4-month long exercise by one crew at the Arctic outpost on Devon Island. That will definitely test the reliability of utility systems, at a location that is logistically quite isolated, as well as be a superlative opportunity for human factors studies. Now if the Mars Society would embrace the projects to the Mars Home Foundation which wished to build a demonstrator Martian Village out of materials available on Mars, that would be really helpful.

MMM Theme Issues: The Lunar Economy - Years 1-25 Dec 1986 - Nov 2011

In contrast, the Lunar Analog Station programs will have no shortage of new things to do and try and test. The clear sign of progress will work to keep the media, and the public interested, as well as to educate them on the possibilities of human settlers making themselves permanently at home on the Moon.

Lunar Analog Outposts and Tourism

When the Moon Society was founded in July 2000, the flagship project announced to celebrate the society's birth was Project LETO [Lunar Exploration & Tourist Organization] conceived of as both a tourist facility and as a research station. On first glance, this would seem to be a marriage made in heaven. But having four weeks of experience at MDRS in Utah, I'm convinced that research is best done without the visual or actual interference of curious onlookers. Now in the 2005-2006 field season we experimented with first one web cam then as with as many as six. This works well, and does not disturb research activities.

What does seem most important, even to the point of being sacred, is to preserve the illusion that you are on Mars (or, in our case, on the Moon) as the illusion helps one take the experimentation and/or exercise seriously enough to ensure superior results. In short, it does not disturb research if visitors or tourists can watch so long as they are out of sight of the researchers.

One way to keep the required separation is the use of web-cams. What about an analog of a duck-blind? That might work for outdoor activities, but without a great number of such blinds, we couldn't ensure visitors that there would be anything worth observing on a regular basis. Web cams or remote TV cameras would seem to be the better answer. Actual supervised "do not touch anything period!" tours could be conducted when the facility was not occupied.

At MDRS, media visits are allowed, but scheduled by program headquarters to minimize interference with MDRS activities. Nonetheless, interfere they do.

Visitor access is important. We will have our faithful followers and enthusiasts who will want the high of seeing this glimpse of the future for themselves. What we can't do is make the analog outpost a zoo exhibit! or create conditions where the crews feel that they are zoo animals. But growing our constituency is of primary importance as well. So how we can best satisfy the needs of both the various crews and the faithful/curious without shortchanging either is an area that deserves much forethought and should be part of the original site plan.

The commercial connection

Whenever or wherever the brand or supplier of any needed equipment is not crucial, the opportunity to have the equipment donated "by the official refrigeration supplier to the Moon Society Lunar Analog Outpost" etc. (for sake of example) should not be passed over lightly. We will always have less money than we need. And when performance or specifications are crucial, all the more reason, for advertising punch to approach a manufacturer or distributor for product donation or free lease.

We have talked many times about the "spin-up" paradigm, much more powerful than the "spin-off" system in place for decades. In spin-up, an entrepreneur develops a technology or product which happens to be needed on the frontier, precisely for the potential "here and now profits" from any terrestrial applications. As we succeed in encouraging entrepreneurs to take this route, they can test and showcase their products at an analog moonbase location, as an effective advertising ploy. The donation of a model, when it can be integrated into the analog moonbase operations, would be a big plus.

We may be the small guys in town, but we have the bigger dreams, the more powerful dreams, the only dreams that make sense in the long run. There may be several analog lunar station operations. Between us, we can leverage our way to reality. <MMM>

A Spartan 11-Step Industrialization Scenario for a Lunar Mining Base

© 2007 David A. Dietzler pioneer137@yahoo.com

The late Dr. Larry Haskin wrote about "A Spartan Scenario for Use of Lunar Materials."

http://articles.adsabs.harvard.edu/cgi-bin/nph-iarticle_query?bibcode=1985lba.conf..435H

In my view, this would consist of using:

- 1) **Unfluxed molten silicate electrolysis** to produce oxygen, iron, iron-silicon alloy, silicon and ceramic blocks. Silicon could be zone refined to high purity for solar panels. Zone refining does not require chemicals that must be upported [shipped up the gravity well] from Earth and will be done more easily in the low gravity and vacuum of the Moon than on Earth where it must be done in inert gas filled chambers and rods can't be too massive lest they fall apart at the molten zone.
- 2) **Cast basalt tiles and linings.** Cast basalt can resist 96% sulfuric acid so it could be used to line metal chambers used for acid leaching of regolith, but first we must develop the base to a point at which we can make H₂SO₄ leaching equipment on the Moon We'd have to mine sulfur present in regolith at about 500 ppm from vast areas of the mare to make the sulfuric acid.
- 3) **Sintered basalt bricks/blocks.** It's my impression, based on discussion with an associate, that experiments were done on large cast basalt bricks or blocks and as they cooled various minerals solidified and settled at different temps, ruining their quality. However small cast basalt bricks have been made. See:

<http://www.lpi.usra.edu/publications/reports/TR98-01/98-01.abstracts.pdf>

BRICKS AND CERAMICS. C. C. Allen, Lockheed Martin Space Mission Systems and Services, 2400 NASA Road 1, Houston TX 77058, USA.

Thus, sintering basalt may be the better ways to make large bricks and blocks. These would be porous enough to bond with cement mortar for wall construction. We must wonder how well cement mortar will hold up under the temp extremes of the lunar day/night cycle.

While indoors this might not be a problem, out vac [out on the vacuum-washed lunar surface] we might want to stack sintered basalt bricks and blocks and sinter them together with microwave heat to build radiation shields for habitat, solar furnaces (support structure for graphite crucibles), foundations for mounting machines, etc.

It may eventually be possible to hew large solid basalt blocks out of the walls of lava tubes.

- 4) **Glass**, fairly clear, from nearly pure beds of highland anorthosite, made by melting this regolith with concentrated solar energy. Glass could also be made from volcanic glass deposits. It may also be possible to extrude these glasses into fibers and bind them with a glass matrix to make glass-glass composites also called GGC or Glax [Glass-glass composites].
- 5) **Nickel.** There are from 0.15% to 0.5 % elemental iron fines containing some nickel of meteoric origin in the regolith that could be extracted magnetically. Some of these iron particles are fused with glass (called agglutinates). Grinding could break up the glass and metal particles and magnets used to draw off the iron. This iron could be melted with solar heat and cast into various forms. Iron powders could be pressed into molds and sintered to make various parts.

MMM Theme Issues: The Lunar Economy - Years 1-25 Dec 1986 - Nov 2011

- 6) **Crucible steel.** Iron from electrolysis and iron fines could be melted, cast into slabs in sand molds, then hammered to drive out silica, then rolled into thin sheets. The sheets would be laid in a box made of ceramic blocks from molten silicate electrolysis and/or sintered basalt with correct amounts of carbon dust obtained by volatile harvesting in between them. This would be heated to red heat. about 1100 C. for 7 to 10 days and the result will be steel. To clean it up further the steel could be melted along with some CaO flux if necessary. This steel could be alloyed with titanium and/or silicon produced on the Moon.
- 7) **Titanium.** Ilmenite (FeTiO₃) could be extracted electrostatically from mare regolith and reduced with hydrogen in a fluidized bed resulting in titanium dioxide and iron. Water produced would be electrolyzed to recover hydrogen and gain oxygen. Fused slag particles of TiO₂ and iron could be ground up or the iron could be extracted with acid leaching. The TiO₂ makes an excellent high temp ceramic and particles of it could be sintered in forms heated by microwaves. TiO₂ could also be put into FFC cells to get titanium metal and oxygen. Titanium powder could be used to manufacture all sorts of small complex parts with electron beam or laser 3D additive sintering.
- 8) **Volatiles.** This should be at the top of the list! Dr. Kulcinski of the University of Wisconsin and his associates have designed volatile harvesting machines that could extract **H₂O, He, CO₂, CO, CH₄, N₂** from the mare. Solar wind implanted **H, C** and **N^{**}** will react with oxygen in regolith and carbon will react with hydrogen to form these compounds when heated to about 900 C. in the miner's on board furnace. See: <http://www.nasa-academy.org/soften/travelgrant/gadja.pdf>
- 9) **Cement, concrete.** According to Dr. T. D. Lin cement can be made by heating anorthositic regolith to 2000–2200 C. to drive off oxides of magnesium and iron and some silica too to increase the CaO content for cement. See: http://articles.adsabs.harvard.edu/cgi-bin/nph-iarticle_query?bibcode=1985lba.conf..381L

Solar energy would be used to heat the anorthosite. Low mass foil or sheet metal reflectors could be used. Of course, to make cement and concrete we need water and that could be obtained by volatile harvesting and possibly from ice deposits in permanently shaded polar craters. Ice on the Moon has yet to be verified, and this is one of the most tantalizing indications made by Clementine and Lunar Prospector.

- ** Solar Wind Volatiles** to be found in the upper meter or two of the regolith also include the noble gases: **Helium** (including the fusion fuel **He-3**), **Neon**, **Argon**, **Krypton**.
- 10) **Aluminum**, aluminum-copper alloy and lithium-aluminum alloy from scavenged ETs or other rocket upper stages. Producing aluminum on the Moon is not simple. Purified (by heating) anorthosite must be melted, cooled and ground fine, leached in H₂SO₄, the Al₂(SO₄)₃ filtered off, roasted to aluminum oxide, then electrolyzed. Fluxed electrolysis (LiF/CaF flux) of purified anorthosite can produce O₂, Si, Al and Ca. These processes are complex and require equipment that must either be imported or made on the Moon, but more challenging is that they require chemicals from Earth that must be recycled efficiently. Solar carbothermal reduction of Al₂O₃ obtained by acid leaching is also possible and seems simpler than these other processes.

We must have electrical wires and cables. The Moon has almost no copper. If we can recover ETs (Space Shuttle External Tanks) or upper stages of a rocket like the Falcon 9 should it ever go into production, transport them to the Moon and melt them down and extrude aluminum and Al-Cu wire, we can get started wiring the Moon base. A 30 ton ET will yield a lot of electrical wire!

- 11) **Precious metals** and other materials from scavenged satellites. Orbital debris is becoming a real problem. It threatens expensive commercial and defense satellites. Any future space program must involve orbital debris removal. There are thousands of pieces of space junk from old upper stages to dead satellites in orbit.

MMM Theme Issues: The Lunar Economy - Years 1-25 Dec 1986 - Nov 2011

Proposals have been made to zap them with lasers and such, but it would be better to use electrodynamic tether systems to snare these objects and collect them and deliver them to lunar orbit. ED tethers require no propellant; only solar energy. A veritable mountain of gold is already in high orbit!

The development of electrodynamic/momentum exchange tether systems would be of immense value not only for orbital debris removal but for transportation of cargos to LLO without propellant. See:

<http://www.spacetethers.com/>

Eventually, lunar industry will progress to a point at which very sophisticated machines can be built like cascade electrostatic mineral separators, perhaps CO direct reduction furnaces that can smelt large amounts of iron from silicates, high temperature plasma separators, electrophoresis devices for extracting trace elements, even bioleaching in microbial farms under well controlled conditions.

Bootstrapping our way to More Sophisticated Levels of Industrialization

But what good are these materials? We will use them to build fleets of helium-3 and solar wind volatile mining machines, drag lines, vehicles, more processing devices to increase materials production without supports from Earth of molten silicate electrolysis units, microwave furnaces, solar furnaces, fluidized beds, FFC cells, grinders, crushers, extruders, rolling mills, tilt hammers, etc. We will build modular underground manned bases with iron, titanium, steel and glass with interior furnishings, floors, and everyday items made of cast basalt. We will build extensive solar panel farms and eventually ring them around the Moon, first at high latitudes in polar regions where the Moon's circumference is not so great, connected by calcium cables (Ca is a better conductor than copper) for constant power during the lunar day/ night cycle. We will build dirt roads with bulldozers and graders built on the Moon, cut and fills into rilles, perhaps even roads paved with basalt slabs and someday even monorails on the Moon.

We will build mass drivers to launch lunar materials into space for the construction of solar power satellites, robotic asteroid mining ships and even space ship fleets for the colonization and terraforming of the planet Mars and exploration of the solar system. Some day we will even engage in megascale engineering in space and interstellar travel. The Moon truly is our platform to the galaxy.

Many Other Useful Products Can be Derived From the Molten Silicate Process

This device requires no chemical reagents and has no moving parts. Oxygen purification will of course involve a gas cleaner and liquefaction will require pumps and space radiators shielded from the Sun and storage tanks. It operates at 1400-1600 C. and produces iron, Fe-Si alloy, silicon and ceramic bricks as well as O₂. To extract Mg, Al and Ca would require higher temperatures and voltages and this leads to container and electrode materials problems as the molten silicate is very corrosive.

From the MMM Glossary [a work in progress]

<http://www.moonsociety.org/publications/m3glossary.html>

- * **upported** – shipped up Earth's gravity well
- * **out-vac** – out on the vacuum-washed lunar surface
- * **Glax®** – glass-glass composites

Unfluxed Molten Silicate Electrolysis	1	6	Crucible Steel
Cast Basalt Tiles and Linings	2	7	Titanium
Sintered Basalt Bricks/Blocks	3	8	Volatiles
Glass	4	9	Cement, Concrete
Nickel	5	10	Aluminum
		11	Precious Metals

<DD>

Everyday people, when challenged, are capable of the most extraordinary things.

MAGNESIUM

Workhorse Metal for the Lunar Frontier?

By Peter Kokh

Magnesium is one of the most abundant elements in the lunar crust, the 6th most abundant element (6%) and the 3rd most abundant metal, after iron (15%) and aluminum (7%). Its powerful affinity for oxygen makes it the energizer in fireworks. We have only fairly recently learned to produce a magnesium alloys (car wheels, etc.) that resists oxidation.

From Hopper Fuel to Structural Elements

Powdered Magnesium could possibly serve as a rocket fuel for lunar surface hoppers. For use on the lunar surface, where exposure to oxygen is minimal, magnesium, easier to produce than aluminum, might find many structural and other uses.

Cement Production

Dr T.D. Lin demonstrated the feasibility of making lunar cement and concrete using the abundant calcium. Calcium-based cement is the basis of Portland cement, widely used around the world, and in terms of sheer tonnage, the world's number one construction material.

But long before the discovery of calcium-based cement, people were making cements made from magnesium. And in some parts of the world, they still are. Could magnesium-based cement and concrete become a major construction material on the Moon? That is certainly one ISRU (in situ [on occasion] resource utilization) area of research that is worthy of major attention. It will be interesting to compare production costs and performance parameters for various uses.

Magnesium Oxychloride Cement

Magnesium oxychloride has many superior properties compared to Portland cement. It does not need wet curing, has high fire resistance, low thermal conductivity, good resistance to abrasion. It also has high transverse and crushing strengths, 7-10,000 psi are not uncommon. It also bonds very well to a variety of inorganic and organic aggregates, such as, saw dust,

MMM Theme Issues: The Lunar Economy - Years 1-25 Dec 1986 - Nov 2011

wood flour, marble flour, sand and gravel, giving a cement that has high early strength, insecticidal properties, resilient, conducting and is unaffected by oil, grease and paints.

<http://www.premierchemicals.com/corner/articles/cements.htm>

Here on Earth, popular myth to the contrary, production of calcium-based cement out of limestone, calcium **carbonate**, is not greenhouse gas neutral but one of the largest offenders. On the other hand, production of magnesium cements soaks up CO₂.

<http://www.laleva.cc/environment/rainforest.htm>

On Earth, we could see a major revolution in the works for the future.

On the Moon, this is not an issue, as calcium is not present in the form of limestone but in anorthosite minerals common in the lunar highlands. However, renewed research on magnesium cements for terrestrial use, could help advance this technology for lunar applications.

<MMM>

LUNAR MAGNESIUM PRODUCTION

© 2007 David A. Dietzler <pioneer137@yahoo.com>

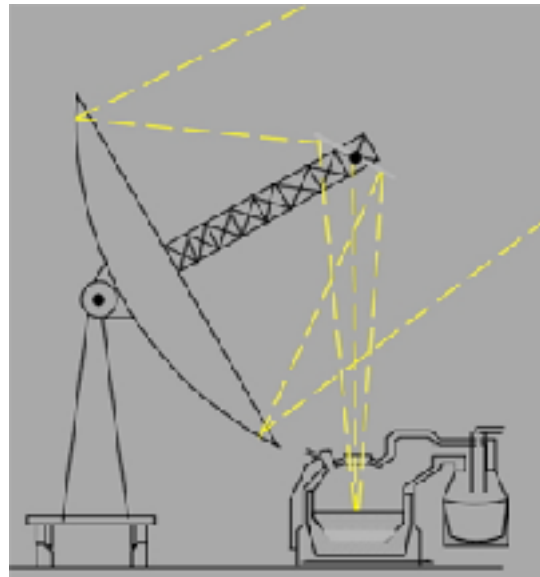

Solar energy is focused into retort containing Mg ore, flux and silicon reductant

Producing magnesium on the Moon might be as simple as heating mare regolith in a solar furnace at 1500 C. and higher to volatilize magnesium oxide. In air at 1 ATM pressure MgO does not melt and volatilize until much higher temperatures; however, in the vacuum of the Moon magnesium bearing minerals will decompose and evaporate at much lower temperatures.

MgO can be used as a iron and steel making flux when mixed with CaO and it can be reduced with silicon to magnesium metal that evaporates and is condensed to obtain magnesium metal. Magnesium can be used to alloy aluminum and it might be used as an explosive when made into a slurry with LOX contained in magnesium tanks detonated by a high energy electric spark.

Silicon for MgO reduction can be obtained from FeSi obtained by molten silicate electrolysis. Some CaO or CaO-Al₂O₃ flux is also required. Iron does not participate in the reduction.

What if producing magnesium was even easier? Aluminum can reduce silicon from anorthite in a lithium fluoride and calcium fluoride flux (1). What if magnesium bearing olivines and pyroxenes after electrostatic separation of ilmenite from mare soil that also separates anorthosite, agglutinates, etc. was done (2)? This would be followed by magnetic

MMM Theme Issues: The Lunar Economy - Years 1-25 Dec 1986 - Nov 2011

extraction of iron bearing olivines and pyroxene. What if the magnesian olivines and pyroxenes (forsterite–Mg₂SiO₄ and Enstatite–Mg₂Si₂O₆ and Diopside–MgCaSi₂O₆ respectively) were simply mixed with a CaO–Al₂O₃ flux and FeSi and roasted with solar energy? More research must be done. <DD>

References:

1) Christian W. Knudsen and Michael A. Gibson Processing Lunar Soils for Oxygen and Other Materials

www.belmont.k12.ca.us/ralston/programs/itech/SpaceSettlement/spaceresvol3/plsoom1.htm

2) William N. Agosto "Lunar Beneficiation"

www.belmont.k12.ca.us/ralston/programs/itech/SpaceSettlement/spaceresvol3/lunarben1.htm

More info about silicothermic magnesium production:

http://en.wikipedia.org/wiki/Pidgeon_process

<http://members.tripod.com/Mg/mggen.htm>

- As insignificant as each of us may seem to be in the scheme of things, the future becomes history through individual acts. Each of us makes a difference one way or the other.

MMM # 208 September 2007

SERVICE HOOKS FOR COMMERCIAL SPACE*

By Peter Kokh

* Part 3 of a larger article “Vanity, Experiences, Service: 3 hooks for Commercial Space”
SERVICES TO CUSTOMERS

Services in Low Earth Orbit

Services could be provided customers of ISS or other future in orbit space stations. That the ISS has been severely cut from its intended size and functions by the Bush Administration pulls the blanket from many of the business plans listed below. None of these ideas are new, many of them based on the Shuttle External Tank [see: <http://www.space-frontier.org/Projects/ET/>] but the volume of need for them, and the way Roscosmos and NASA do business hasn't left much incentive for them.

- **An orbital tug** to move satellites and other items from one orbit to another, or simply to give them a boost back up to a longer-lived orbit, including geosynchronous orbit
- **A fuel depot** for craft bound for GEO, the Moon, Mars
- **A maintenance and assembly garage** with parts and tools cribs and teleoperable robo-mechanics
- **A derelict satellite salvage business.** Any part or material that can be reused and is already in orbit is much less expensive than an equivalent still on Earth
- **A supplier of consumables & collector of wastes.**

Services in GEO – geosynchronous Earth orbit

GEO is getting crowded. By international agreement, parking positions must be 2° apart, meaning that there are only 180 parking spots available. Meanwhile worldwide demand is on the increase.

MMM Theme Issues: The Lunar Economy - Years 1-25 Dec 1986 - Nov 2011

The obvious solution is **GEO-condominiums**, giant platforms at each slot to which an unlimited number of satellites could be attached. The platform would provide solar power, station-keeping, and communications, services that the satellite owner would purchase or rent or lease. This condominium platform idea is so obvious that it has occurred to a number of people. But no one yet has taken the plunge. In time it will become a matter of national interest, but we'd much rather see this developed by private enterprise or consortia than by inefficient socialized national space agencies.

Another business plan for GEO is to **introduce space solar power by the back door, using relay satellites to beam power** from one place on Earth where there is an excess to another place where there is a deficit. In other words, we would jump start solar power generation sats by simply introducing solar power relay satellites.

Site Development Services on the Moon

Even before the first national space agency or dark horse commercial enterprise lands a first permanent habitation module on the Moon, there are options for private enterprise – opportunities to pave the way. Part of Applied Space Resources Lunar Retriever mission plan was to pre-land two robot rovers that would clear, fix, or stabilize the troublesome ultra-fine abrasive moon dust that could damage expensive equipment that might be stationed there later.

We can imagine a host of other useful services, each of them involving teleoperators on Earth and tele-operable equipment on the Moon:

- Identifying the best area for a space landing pad to receive intensive regular usage, clearing it of boulders large and small, grading it, compacting and sintering the soil, then install a trio of transponders 120° apart along the periphery.

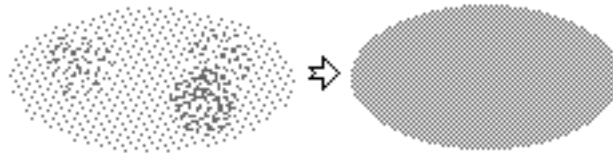

- **Also identifying the best site** for an outpost with ample room for expansion, and clearing and grading that site along with a “road” to the landing/launch pad.
- **Identifying best adjacent areas** for warehousing, solar panel arrays, and other special uses, and preparing them also.
- **Testing** how high above the lunar surface moondust is levitated as the terminators pass, of vital importance to designers of automated teleoperable telescopes.

MMM Theme Issues: The Lunar Economy - Years 1-25 Dec 1986 - Nov 2011

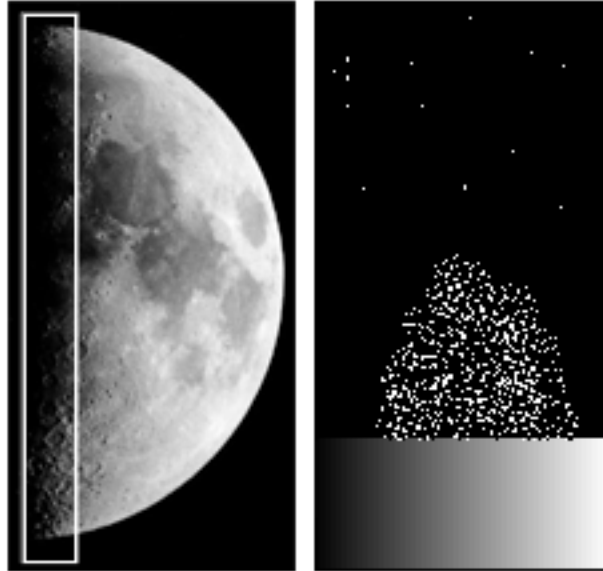

- **Solar arrays** could be installed, complete with buried or trenched cables to the main outpost area and to the landing pad area. Then when the first habitat units are deployed they can be hooked up to power right away.
- **Manufacturing** on location sand bags filled with regolith or sintered blocks of moondust to be used as removable radiation and thermal shielding.

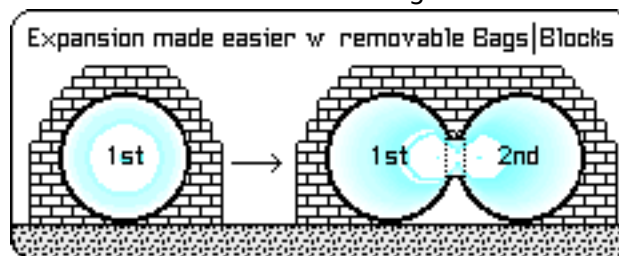

- **And/or manufacturing** of the structural elements needed to build a space frame canopy, then shield it, under which the various habitation modules could be towed and hooked up together.

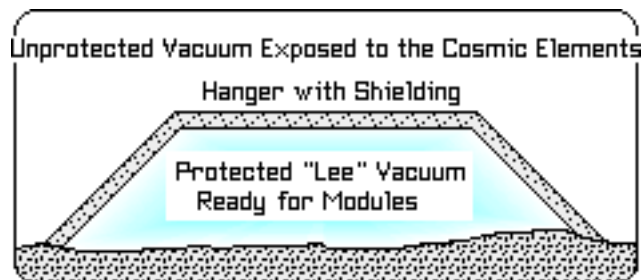

All of these services could be farmed out by NASA or any other national space agency, to commercial developers.

For more, see MMM #131, December 199, pp. 10-11 "Luna City: The Developer's Role" (reprinted in MMM Classic #14) http://www.moonsociety.org/publications/mmm_classics/mmmc14_July2006.pdf

[All MMM Classic volumes are free access downloads without a Moon Society username and password, at the above location. Currently all the non-time-sensitive material from MMM's first 21 years are preserved in this archive, one pdf file per publication year.]

MMM Theme Issues: The Lunar Economy - Years 1-25 Dec 1986 - Nov 2011

Tourist site preparation tasks

- **Rovers** preparing sites for Tourist Centers on the Moon could, in the process of site preparation, take photos for use in putting together Tour Guides to use as preliminary advertising.
- **In the meantime**, rovers could shoot still and moving panoramas in high resolution of any exceptional scenery around to be used as backgrounds for documentaries and science fiction films. For those old enough to remember, many a cowboy and western film used backdrop scenery previously photographed in SE Utah's Monument Valley.
- **Other scenes** worth taping are local sunrise, local sunset, and how the area looks during a total lunar eclipse as seen from Earth; any near by scarps, lavatube openings, exposed bedrock, etc.

"As long as we're here...": Secondary Profit Generators

In 2002, four members of the Oregon L5 Society NSS chapter based in Portland, Oregon, Bryce Walden, Cheryl York, Tom Billings, and Bob McGown put together an interesting list of enterprise opportunities on the early frontier. You can download this paper at:

www.OregonL5.org/docs/sr2002d.pdf

The following ideas are nearer term seeds for early lunar enterprise: (editor's selection and sequencing from a much longer list.)

- **Prospecting**: Ore concentrations (of non-primary elements) on the Moon may require actual prospecting to discover. This would be most efficiently done with hordes of small insect like rovers with geochemical sensors, with humans to follow up later on any samples "tagged" by the robot prospectors as worth a human second look.
- **Prospectors and mappers** should be able to sell precise ground-truth data for a price worth their time and effort.
- **Collecting Moondust** . Regular commerce will increase the supply and lower the cost. The potential market is huge, however both
 - # **for pre-developers of those building and manufacturing materials** that could be produced on the Moon.
 - # **and for those experimenting with Lunar-appropriate Arts and Crafts** , made on Earth from returned moondust material. Later artifacts could be made on the Moon by crew in spare time.
- **Web-cam relays** from fixed and roving cameras might be popular, documenting the whole process of site development, deployment of first phase of the base, etc. Such films would be invaluable training tools for those to follow.
- **Entertainment** . Base crew could **hire out to terrestrial filmmakers to provide unique locations** during their off hours only, and with pre-approval.

A teleoperator DJ on Earth could select music to be played on the Moon and broadcast back to Earth, with announcements ("Our next selection is Arthur's Theme [refrain 'between the Moon and New York City'], in honor of Mary in Manhattan who is celebrating her 29th birthday, from Chris with love")

1. **Only** those service options which do not take up crew time needed for their principal mission assignments should be considered, unless they lay foundations for a more productive follow-up mission, such as ISRU experiments, power system installations, etc.
2. **Commercially provided equipment** should include payment for their weight and volume as these are costs of transportation to the Moon.

Looking ahead to Moonbase Design & Operation

The authors of the paper "As Long as we're here" have recommendations for moonbase designers who by nature of their funding realities tend to be extremely conservative to the point of being "contraceptive." If we fail to allow for expansion, not only in size, but also in function, there is no point in putting up a base at all.

MMM Theme Issues: The Lunar Economy - Years 1-25 Dec 1986 - Nov 2011

“Many visions of Moon and Mars bases portray small, government-supported outposts conducting pure research. Like an Antarctic base, the outpost is a drain on the economy of its sponsor.”

“Space facilities should include some capacity to host visitors. Tourism support presents business opportunities for travel agents, guides, tour companies, housing and housekeeping, restaurants, gift shops, transportation, and entertainment.”

“Many small businesses, each contributing in their own way to the economy, will be more robust, more sustainable, and more enriching than any single target business. Planners should consider a community’s need for small business locations and support infrastructure. Extra space should be allowed for unforeseen purposes, and for expanding families, small businesses and tourist needs. If planners do not provide avenues for growth, they may make it impossible for communities to thrive.”

That’s hitting the nail on the head! <MMM>

MMM # 209 October 2007

THINKING OUTSIDE THE MASS FRACTION BOX: 1 NASA’s Lunar Architecture Design Goals are Good, but not quite what we need to Maximize our Lunar Presence Investment

By Peter Kokh

Moon Society Advisor and Videographer Chip Proser has asked me to define the steps we need to take to realize a human presence on the Moon to support a full buildout of an Earth-Moon Economy. Actually, we have talked about most of the elements and steps needed in various articles in MMM through the years.

Thinking within the “Mass Fraction” Box

But it is a very worthwhile endeavor to do the exercise afresh, and with deliberation. We’ll make a start with this article, laying out basic concepts to “really maximize” the payload delivered to the Moon. This means throwing out the window of the slavishly worshiped law of “mass fraction.” According to Wikipedia,

“In aerospace engineering, the **mass fraction** is a measure of a vehicle's performance, determined as the portion of the vehicle's mass which does not reach the destination. ... In rockets for a given target orbit, a rocket's mass fraction is the portion of the rocket's pre-launch mass (fully fueled) that does not reach orbit. ... typically around 0.8 to 0.9 [80–90% of the takeoff mass does not reach orbit]”

The figure is even more discouraging when we are considering the typical mass fraction deliverable to the lunar surface.

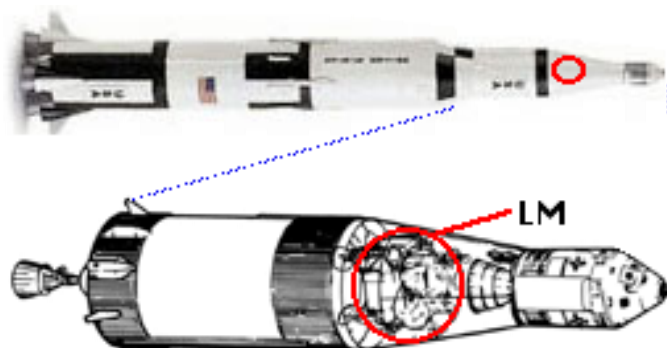

MMM Theme Issues: The Lunar Economy - Years 1-25 Dec 1986 - Nov 2011

The goal, adopted by NASA, to design the landing craft in such a way as to maximize delivered payload, is excellent. According to the Connally Study:

- minimize ascent module mass
- minimize descent module mass
- maximize landed “payload” mass
- simplify interfaces
- move functions across interfaces when it makes sense

Thus, by use of a minimal ascent vehicle, NASA can land a much more spacious crew cabin. But this is still a sample of thinking within the Mass Fraction Box.

Thinking outside the “Mass Fraction” Box, Part 1

When you think of it, the payload “landed to remain on the Moon” in the Apollo missions consisted only of the descent stage, and assorted equipment left behind. Not much! NASA’s new “space-motorcycle”-inspired plan will allow leaving the spacious crew cabin behind. That’s a big step, but still within the “Mass Fraction Box.”

Our first article on “Thinking outside the “Mass Fraction Box” was “**Essays in ‘M’:** Marshall MacLuhan: “**Medium is the Message**” in MMM #6, June 1987. This is republished in MMM Classic #1 – http://www.moonsociety.org/publications/mmm_classics/mmmc1_Jul2004.pdf

In this article, we pointed out that the most common flaw in thinking within the “mass fraction box” was to assume without question that no part of the vehicle itself could be reassigned as “payload.” We illustrate the possibilities by offering an alternate configuration for the Space Shuttle Orbiter. I urge you to download that volume cited above, if only to get this point across.

Here we are talking about delivery to the lunar surface. In that context, our quest to cheat the “mass fraction” rules drives us to make sure **that everything that we have paid precious fuel to land on the Moon, and which will not depart on the ascent vehicle, is something that has more than temporary usefulness:** that includes every part of the landing platform mass:

- Fuel tanks & descent engine & • vernier rockets
- Cargo hold & • unloading equipment
- Lleg struts & • foot pads, • etc.

There are several approaches and types of solutions for this design challenge:

- The item can be reused as is, for example, the bulk of the descent platform, minus engines and fuel tanks, might be reused as a platform for a telescope
- The design of the item could be tweaked to enable it to serve some different application, whether similar or quite different, e.g., landing struts could be assembled in line to use as an antenna mast, or alternatively to serve as part of a space frame for a canopy shed
- Perhaps part of the descent stage equipment could be designed as a mobile chassis for the crew cabin, either to taxi the cabin to its installation site, or to turn the cabin into a pressurized lunar surface bus.
- The item could be forged of a material invaluable on the Moon, such as lead, copper, brass, or stainless steel; some components, for example shipping stuffs, could be made of reusable plastics, or compressed biodegradables rich in nutrients scarce in the regolith

You get the idea. See “Stowaway Imports,” in MMM # 65, May 1993, republished in MMM Classics #7, downloadable from web address above.

We would be delighted to see the NASA Moon Lander Office adopt these design goals also. This is not a new philosophy. Poor people are known to use all parts of a slaughtered pig “except the squeal!” NASA should and must adopt a “we are poor” posture, in the sense that the agency will never get all the money it might want and must learn to make do with what it gets. And to do that successfully, means not to cut this and that, that’s a petulant knee jerk reaction, but to exercise maximum resourcefulness. Use everything twice!

MMM Theme Issues: The Lunar Economy - Years 1-25 Dec 1986 - Nov 2011

Note that our subtitle at left reads: "Thinking outside the "Mass Fraction" Box, **Part 1**" We hinted in our reference to the article from MMM #6, that the launch vehicle itself, and every stage of it, can be redesigned to add more to what lands on the Moon and **contributes to the buildup of the lunar outpost/settlement**. We'll leave you with that thought until next time.

MMM>

"Vision without action is merely a dream.

Action without vision just passes the time.

Vision with action can change the world."

- Joel Barker, Futurist

"Do not go where the path may lead.

Go instead where there is no path, and leave a trail."

-
-

Mongolian proverb

MMM # 210 November 2007

THINKING OUTSIDE THE MASS FRACTION BOX: 2 Improving on NASA's Lunar Architecture Design Goals

By Peter Kokh

In the first installment last month, Part 1, we talked about making maximum use of everything landed on the Moon. That way everything we land on the Moon becomes payload delivered, not just the crew and cargo. Let's carry the argument further.

The Translunar Injection Stage as a Deliverable

Any part of the Earth Orbit <> Lunar Orbit ferry vehicle that delivers the landing craft to low lunar orbit for its descent to the Moon's surface, which is not needed for the return to Earth orbit can be delivered the rest of the way to the lunar surface at little extra cost. What things this may consist of depends on the vehicle's design. Expanded fuel tanks (unless they are refueled with lunar liquid oxygen) and farings are two obvious suggestions. Of course, this implies that these items can be replaced in LEO for the next trip out to the Moon.

In Apollo, the Saturn 3rd stage that brought the LEM and Apollo Command Module was effectively tossed overboard, left to crash on the Moon. (area in dotted box)

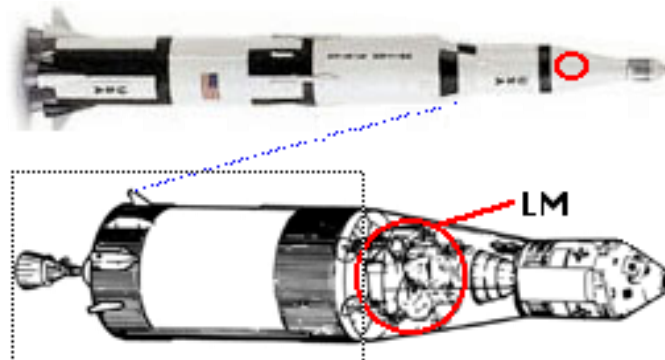

MMM Theme Issues: The Lunar Economy - Years 1-25 Dec 1986 - Nov 2011



Saturn SIVB left

SIVB Adapter Skirt right

http://en.wikipedia.org/wiki/Saturn_V#S-IVB_third_stage

The SIVB: 58' 7" [17.85m] tall/long; 21' 8" [6.6m] wide, such a volume landed could provide ample storage, or, set on its side, a spacious 2-floor habitat module. The adaptor skirt covered the SIVB engine and mated the SIVB to the Saturn 2nd stage. This could be saved also.

Yes, to deliver this stage the rest of the way to a soft landing on the Moon requires more fuel, but at least the oxygen required could be brought up from the lunar surface. Delivered, this adds large fuel tanks which could be put to welcome use in the moonbase, plus an engine, cannibalizable wiring and other components. Remember, we already paid the freight to get it almost all the way!

Those with shortsighted vision would not want to bother, but if you are a prospective lunar pioneer, not to take advantage of such a golden opportunity would be unforgivable, and as lunar frontier history may someday judge, forever listed as an act of unthinking treason against the future Lunar Republic.

We are not suggesting that the Lunar Module ride to the surface atop this 3rd stage, though if we decided to do that, the weight savings involved in not needing to equip the Lunar module with its own separate descent stage engines and tanks, might go a good ways toward paying for the extra fuel.

The equivalent of the Apollo Command Module needed to return crew to Earth orbit or to Earth directly, could be dropped off en route, breaking into lunar orbit, while the 3rd stage with lunar module and minimized ascent stage continued directly to the lunar surface. It's a different lunar architecture but the potential payoff in "total payload delivered" is too great not to pursue. As we work out the design and tradeoff particulars, a show-stopper problem may emerge, but with the right attitude, we can bet that a doable workaround will be found.

In the scenario above, even the farings that protected the lunar lander on its trip up through Earth's atmosphere, could make the trip all the way. They would surely be useful for one thing or another.

A Proper Guiding "Philosophy" is essential

We must always keep in mind that maximum total payload mass delivered is the Holy Grail. That implies, of course, that we have predesigned every "hitchhiking" component to be able to serve new uses and functions on the Moon, or have made that component of a material that we cannot yet produce on the Moon, or may never be able to produce, such as copper, brass, zinc, lead, and reshapable thermoplastics, to name a few.

What about parts for which we can foresee no reuse or reapplication potential? We can think of two approaches right off the bat. Make them of materials needed on the Moon. Store them up until someone does have use for them. At the very least, they can be used in frontier sculptures, symbolizing the effort it took to establish the frontier! Art is one very important way we begin to accept our new surroundings as "home."

Face it, we will not have bottomless financial reserves, we will need to be spartan. Why not borrow the operating principal used by the poor who need to use all of everything that comes their way, in this example, a slaughtered pig -- "use everything except the squeal." To put it in more common terms, we need to maximize and ramp up our "resourcefulness."

MMM Theme Issues: The Lunar Economy - Years 1-25 Dec 1986 - Nov 2011

This is not “Apollo II”

We need to remember that in the Apollo program, the idea was not to establish a permanent base, but to conduct a series of science “picnics” at scattered surface sites. In that light, minimizing landed mass on the Moon was the proper design goal. Now, as we pick one site and try to build it up to the point where it becomes a truly functional complex serving a wide variety of operations on a long term basis, everything changes. We will want to deliver as much, not as little, as possible.

By including as second class payload, not just crew, cargo, and initial cabin, but the entire landing craft and perhaps the entire assembly that left Earth orbit bound for the Moon, we demolish the Old “mass fraction limits” on deliverable payload. And we demolish those limits at relatively little extra expense. The payoff of adopting this design philosophy is that a given stage of moonbase buildout can be reached in fewer trips from Earth, or conversely, with the same number of trips from Earth, we can reach a much larger, more complex and elaborate lunar outpost buildout.

This is important for an operation that needs to maintain public and political support to continue. The more we achieve with the lowest cost, the faster our presence on the Moon grows first to a fully functional science and exploration outpost, then towards one involving a growing number of civilians involved in industrial operations aimed at tackling Earth’s energy and environmental problems, the more surely it will survive changes in political administrations, and congressional whims.

A parallel with the Opening Act of the Universe

The only safe lunar outpost expansion philosophy is an “inflationary” one, growing and evolving very fast, not very slow. Until we reach a stage where our presence on the Moon can survive periods of interrupted support from Earth, everything is tentative, subject to a change in the winds that could mean a second retreat from Luna.

Such a swift buildout approach will, when all is counted up, be significantly less costly than a go slow, pay as you go approach. Time is the most costly expense of all. We should know this from the Shuttle program. Initial cost per launch figures were based on sixty launches per year, one every six days. Now we are lucky to do four or five. But the expense of the standing army of people needed for turnaround, as well as of management, never goes down in proportion to mission rate.

Further, with each delay, inflationary pressures come into place. To get our money’s worth we not only have to reuse everything sent toward the Moon on the Moon, but we need to buildout our lunar facilities and operations with all due speed.

The “Medium is the Message”

We noted last month that extending Marshal McLuhan’s dictum that the Medium is the Message to rocket transportation and delivery architectures, the rocket itself can be part of the payload, if properly designed, in all its parts, for useful applications at the delivery site.

Meanwhile, the original second stage, which delivers the moon-bound stack to Earth orbit, should itself be predesigned so that all its components can serve some useful function in Earth orbit, building up the transportation hub with refueling, assembly, and maintenance operations functions. We’ve already paid the freight to deliver its fuel-expended dry mass to LEO. If we do not leave it there and find some way to use it to ramp up orbital operations, we are just tossing money away. Here too, we can treat the Mass Fraction limits.

It begins to look as if the Mass fraction rule was a product of neanderthal thinking. We got to where we are by taking advantage of every opportunity, not by mindlessly throwing opportunities away, because in our narrow horse-blinded professions we can’t see the possibilities!

MMM

THINKING OUTSIDE THE MASS FRACTION BOX: 3

The Block & Tackle Pulley as an Analogy of the Power of Leveraging Concurrent Space Developments to deliver much more to the Moon

By Peter Kokh

“ in Earth orbit you are halfway to anywhere” – Robert A. Heinlein

The “effective” cost of goods delivered to the lunar surface depends on the amount, or lack of infrastructure along the way.

Archimedes invention of the pulley more than 2200 years ago is one of the most important mechanical contributions to early civilization. By realizing a predictable mechanical advantage, the “energy cost” of moving an object from one plane, say Earth’s surface, to another, say the Moon’s surface is significantly reduced. The block and Tackle pulley multiplies the advantage.

What does this have to do with space transportation in general, and with the cost of delivery of goods from Earth to the Moon in particular? We certainly are not talking about setting up a physical block and tackle system in space! Rather we want to apply the analogy above in a way that illuminates the best way for us to proceed.

In short, transporting things to the Moon without any intervening infrastructure, i.e. not cashing in any infrastructure discounts or advantages, is going to remain very expensive. The “Moon Direct” plan, if we can call it that, is the “horse blinder” choice. “We are directed to put an outpost on the Moon, not to establish infra-structure along the route.” What looks like dedication will someday reveal itself to be an outright waste of resources and opportunities. Future Lunans may even view it as criminal.

In previous parts of this article, we have noted that anything taken to orbit that might be useful in setting up shop on the Moon, but left to fiery destruction as its orbit decays, could be taken to the Moon at much less expense from LEO than from Earth’s surface – if Heinlein is right, for about half the cost. And that includes a lot of material, whether usable in its current form or not. The deliberate “wasting” of the External Tank is but the most obvious and long standing forfeit of opportunity. We fully understand all the disadvantages and obstacles to reusing the ET. But they are insignificant in comparison to what could have been gained by committing to the modest expense of parking them in a higher very long duration orbit until the opportunity to use them in LEO or take them to the Moon arose. As a Society, we have become addicted to favoring short-term advantages over long-term goals, and such a habit, if we don’t fight the addiction, could have us following the Romans into oblivion. Again, I understand the excuses. But excuses are just what they are.

The same holds true of anything else delivered to LEO and GEO, which when no longer useful there, could be delivered to the Moon at “half the cost.” LEO and GEO are pulleys in any future fully developed lunar transportation system. So is the Earth-Moon L1 Lagrange point and other lunar orbits. Anything delivered that far that could be used, reused, restructured, or cannibalized on the Moon will be far cheaper to deliver than an equivalent item all the way from Earth.

The Lunar side of the Block & Tackle

I remember Gordon Woodcock’s paper which sought to prove that lunar oxygen used to refuel Moon-bound cargo ships, could only reduce the cost of shipping to the Moon, but not make it profitable. Duh! What’s wrong with reducing costs? Lunar oxygen, which is abundant beyond exhaustion, can be shipped to L! and to LEO with every returning vehicle, to partially refuel each next Moon-bound craft. LOX is thus another pulley in the system. As to LH2, which is not in large supply on the Moon, we oppose shipping that off-Moon as fuel, or even for using on the Moon as fuel, except for fuel cells in which hydrogen can be recovered. Any shipment of

MMM Theme Issues: The Lunar Economy - Years 1-25 Dec 1986 - Nov 2011

hydrogen off the Moon limits the size to which lunar settlements and biospheres can grow. In that perspective, such shipment and usage becomes treasonable against the Lunan Frontier.

Lunar Exports

Many people point out that the Moon has nothing of value “on Earth” except perhaps Helium-3, and maybe platinum (I am very dubious of this latter idea.) What these people are failing to understand is that the logical export partner of the Moon, is not Earth, but LEO. Anything that can be made on the Moon to fit service needs in LEO can be shipped to LEO at a 20:1 fuel cost advantage over shipment of equivalent goods up from Earth’s surface. Of course, that statement does not factor in the need to amortize the costs of developing lunar industries needed to export such items. That does not change the argument, however.

Items made of concrete, cast basalt, glass, alloys of steel, aluminum, magnesium, and titanium are candidates. Yes, there will be some specialty materials that lunar industries won’t soon be able to match. But in designing LEO installations – space stations, laboratories, factories, tourist facilities, whatever, if the design team tweaks the design to use lunar products, the cost savings will be considerable. Even dehydrated food, over 50% lunar oxygen by weight, can be shipped more cheaply to LEO than from Earth! The point is, that all these export products will help defray the cost of shipping things in LEO the rest of the way to the Moon. Another Pulley!

Not to forget GEO

GEO -- Geostationary Earth Orbit -- is long overdue for wholesale restructuring of the way the limited and invaluable slots along this orbit are assigned and utilized. With large platforms supplying power and station keeping, serviced by robotic tugs, many communications and other GEO satellites can share the same orbital slot, taken to the platform by the tug, and “plugged in.” GEO is almost saturated in our present “hunter-gatherer” level of allotting space. How will products from the Moon help?

We already understand that lunar materials can bring down the cost of solar power satellites and relays in GEO by substantial proportions. [See last month’s MMM proposal for a World Wide Orbital Grid.] These same materials can help build new and larger platforms for communications and other uses. And the tugs needed will be of use as well in LEO in maximizing reuse and salvage of items in orbit, including gathering them for transshipment to the Moon. GEO platforms, power systems and tugs -- another Pulley”

“Mechanical” Cost Advantages

Any estimate of what it will cost to open the Lunar Frontier, that neglects the opportunities to ship to the Moon anything shipped to LEO, GEO, or other points in between and no longer needed at those points, or which neglects to credit exports from the Moon to LEO, GEO, or other points between will necessarily be fantastically outlandish.

At the same time, we are not saying that opening the Lunar Frontier will quite pay for itself in the near future. That said, we are confident it will do so much more quickly than most authorities now estimate. Those less optimistic predictions are a natural, given the human tendency to be too optimistic in predicting the near-term future and far too pessimistic in predicting the long-term future.

I was asked recently to outline “The Ten Steps Needed to Create an Earth-Moon Economy.” I dislike pre-set outlines. Whether it is five steps or fifty is uncertain. But this set of articles on “Thinking outside the Mass-Fraction Box” are my first installment towards an answer to that request. In other words, we are not going to succeed in setting up an Earth-Moon economy without paying attention to “the pulley points” along the way.

LEO & GEO can only be fully developed using the significant cost advantage of Lunar materials and exports.

The Moon cannot be fully developed without access to materials and items shipped to LEO which when they are of no further use there, are then transshipped to the Moon.

MMM Theme Issues: The Lunar Economy - Years 1-25 Dec 1986 - Nov 2011

The first Step: a refueling station in LEO

At the 2007 International Space Development Conference in Dallas over the Memorial Day Weekend, Dallas Bienhoff of Boeing gave a convincing presentation that simply by refueling Moon-bound craft in LEO, we could deliver 60% more goods for the money. Please view the three video segments produced by the Moon Society in which Bienhoff explains his thesis.

<http://link.brightcove.com/services/link/bcpid537086541/bclid537026504/bctid1171893807>

<http://link.brightcove.com/services/link/bcpid537086541/bclid537026504/bctid1173355232>

<http://link.brightcove.com/services/link/bcpid537086541/bclid537026504/bctid1171893809>

Bienhoff is correct in saying that NASA has an obligation to identify the least expensive way back to the Moon. However, that constraint imposed by Congress, is shortsighted, in words we all know, "pennywise and pound foolish." The current Spartan approach can only be defended if setting up a lunar outpost is a goal in its own, without considering further use of that outpost, or further lunar developments.

Many years ago, I wrote in an In Focus editorial which I can't locate at the moment, that the space enthusiast community has all too often attempted to sell the ladder of our dream one rung at a time. When we do that, the rung in question gets designed as a be-all and end-all in itself, not as a rung leading to the next rung, not as part of the ladder. Thus we have only ourselves to blame for the Space Station becoming a black hole for funding, leading nowhere. In the selling of the Station, it became not a depot to outer space as conceived of by Wernher von Braun, but a downward looking Earth-research laboratory, the pride of "yo-yo space." We were afraid that if we talked about our real dream, no one would listen. The result of this space enthusiast consensus strategy of the early eighties is 20-some years since of going nowhere.

If we promote the NASA permanent, but not permanently occupied, science outpost as a goal in itself, that's what it will become. Because we can't allow ourselves as a nation to look further down the road, we will continue to make stupid shortsighted decisions which will only bring further delays to opening the Moon.

Anything that is worth doing is worth doing right. We have to rethink the NASA moonbase as a rung in a ladder, that means flushing LAT-2 down the LATrine. It's a quite brilliant design intended to lead to nowhere.

Ten Steps to an Earth-Moon Economy?

It includes building up a block-&-tackle-reminiscent set of cost savings enhancers in LEO, GEO, L1, and on the Moon itself. And it includes dumping LAT-2 constraints. NASA has rightfully canceled further biological life support system research as not of use for its current concept of the lunar outpost. Can there be any more eloquent clue that the agency is off track, way off on a tangent?

NASA itself admits the potential for using lunar resources, but has chosen for this Congressional assignment to constrict its vision to what is pertinent for the mission so defined. In its dedication, NASA has unwittingly chosen to become part of the problem. Yet the agency has enormous expertise and problem solving resources. It needs a change in direction that unleashes those talents. Perhaps the next administration will see to that. In the Apollo program, NASA was at its prime. Under present leadership, the agency is playing a caricature role, expertly. But this is the price we pay for a space program that continues to be a political football.

We, those of us in the bleachers, disparaged by NASA and the government alike, have to be vigilant for ways to make an end run around what is happening. The LEO and GEO and even Lunar export options we have mentioned will be the work of private enterprise. That's our point of entry. Optimism has to be earned. <MMM>

[Early Lunar Industry]

HEWN BASALT PRODUCTS

By Peter Kokh

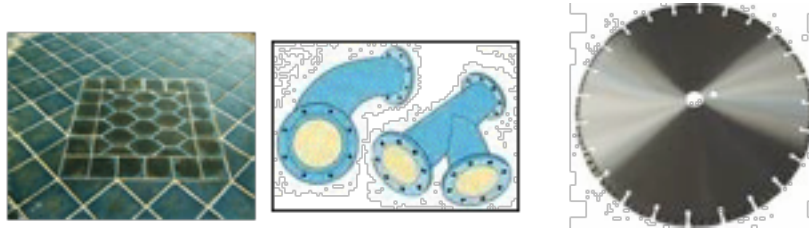

Right: cast basalt tiles and pipes. Left: "hewing" saw

Cast Basalt

In a past article [MMM #135 - May 2000, p. 7] we have talked about "Cast Basalt" - basaltic moondust from the lunar maria or "seas" (of congealed lava sheets) that, given ample precedent here on Earth, can be made into durable, functional, even beautiful tiles for floors, countertops, walls and more. Further, cast basalt is highly abrasion resistant. Cast basalt floor tiles should resist being dulled or scratched by any moon dust that gets into living spaces.

This same quality has led to a major industrial use of cast basalt liners for material handling chutes and pipes and associated fittings. Both these uses will be most helpful on the early frontier.

Hewn Basalt

Hewn basalt is a chemically related, but structurally different product that may precede cast basalt as an early frontier industry. Here we are using not pulverized basaltic moondust, but solid basalt, that can be cut into blocks (and tiles) for many practical uses. Hewn basalt blocks of various sizes and shapes can be used to build columns, retaining walls, and shade walls. They could be cut on angles to build arches. Such blocks would serve many practical external uses in unpressurized spaces.. Here we are using not pulverized basaltic moondust, but solid basalt, that can be cut into blocks (and tiles) for many practical uses. Hewn basalt blocks of various sizes and shapes can be used to build columns, retaining walls, and shade walls. They could be cut on angles to build arches. Such blocks would serve many practical external uses in unpressurized spaces.

Finding solid, minimally fractured basalt

The pulverized and impact gardened "regolith" blanket is on the order of 2-3 meters/ yards thick in the basaltic maria. If we scrape off this top layer, we should reach fractured, increasingly pure basalt. The further down we go, the less numerous the fractures.

Another opportunity will come in road construction, where to smooth out hill, a cut and fill operation may be needed. The lower part of the "cut" could expose fractured, more or less pure basalt.

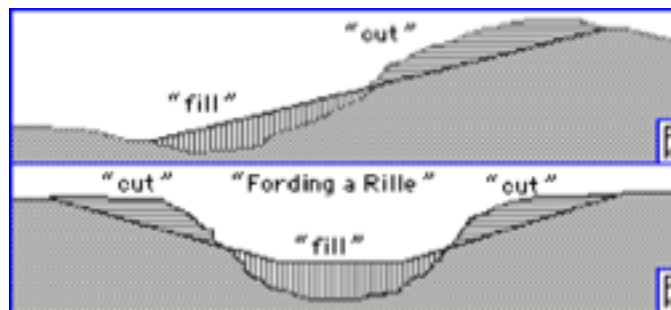

MMM Theme Issues: The Lunar Economy - Years 1-25 Dec 1986 - Nov 2011

Basalt Blocks hewn from Lavatube floors

Where a settlement area includes a nearby intact lavatube, it is likely that, in the process of getting it ready for use, whether as a spacious pre-shielded industrial park or warehouse or agricultural space, or even as residential space, we will want to smooth out irregularities in the tube floor. The tube floor is likely to be relatively free of fractures. Thus the various sized blocks we cut out are likely to be of a superior quality.

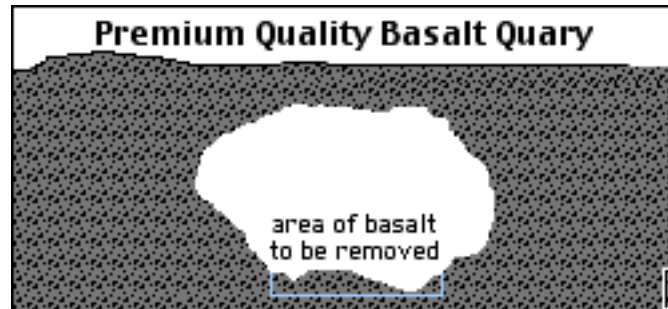

It is basalt blocks from lavatube quarries that will be in most demand. Satin finish quarried tiles may be an architectural material of choice for some applications as it will have a different look from cast basalt tiles.

Hewn basalt blocks may be applied to exteriors of private, individually shielded homes, as retaining walls for moon dust, to give exterior mounds a controlled shape as a sign of wealth and prestige.

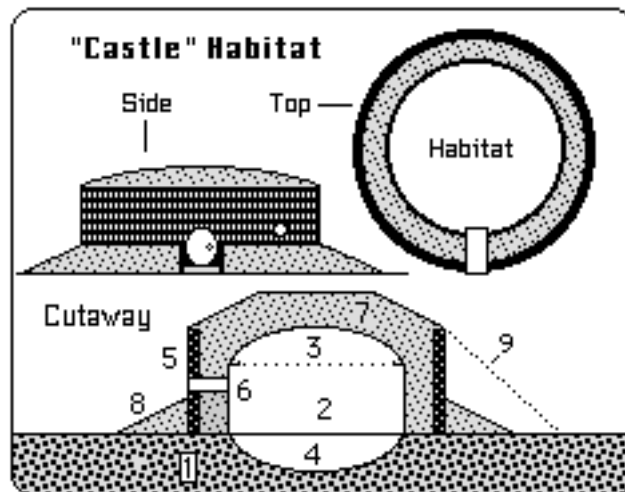

KEY: (1) surface, minimally excavated to nest the rounded bottom of habitat hull; (2) Habitat Hull, in this case a squat vertical cylinder with round end caps; (3) vaulted, cove-lit ceiling; (4) "basement" area for utilities and systems and extra storage; (5) the "castle" rampart retaining wall made of cast basalt blocks with openings for narrow windows; (6) shaft for "window"; (7) regolith moon dust shielding and (8) berm; (9) slope of shielding without a retaining wall

Hewn Basalt Blocks as Sculpture Medium

Carving basalt blocks into sculptures of all sizes is an age old craft, practiced in Egypt and elsewhere. The columns of temples and other great buildings were often carved from basalt blocks.

But smaller sculptures and decorative items were also carved from basalt, a wonder, as we now have much superior tools such as titanium-tip chisels. Given the lack of other natural carving materials on the Moon, cast basalt statues and sculptures are sure to be a mainstay of lunar frontier homestead décor, as well as on a larger scale, of larger sculptures for public places, both within pressurized spaces and out on the surface in prominent locations. Art will

MMM Theme Issues: The Lunar Economy - Years 1-25 Dec 1986 - Nov 2011

be one major way in which we put a human stamp on the moonscapes surrounding our settled areas.

Both for curiosity and to use for “show and tell” the writer bought this sample, a Scarab, online from a shop in Egypt. The photo does not do it justice!



Cast Basalt Blocks vs. Sintered Blocks

Perhaps the first manufactured building material lunar brainstormers came up with is simple blocks of moondust compacted by vibration in a mold, then sintered into a solid by microwaves. Such sinter blocks would look a lot like our concrete sinter blocks, and have a similar density and cohesiveness (or lack thereof.) It is certain that sinter blocks will be cheaper to produce and perform well enough for some purposes. In other applications, where hardness and density and visual quality are important, hewn basalt blocks may have the edge. At any rate, it is important both to support a greater variety of uses as well as to provide customers and consumers with choices, to develop all the near-term options.

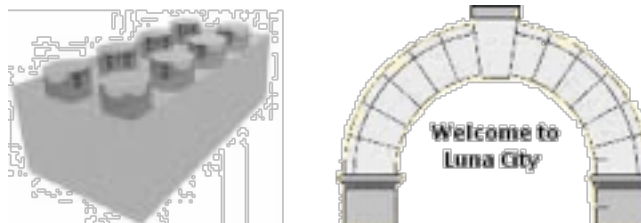

One advantage of the sintered moondust block is that, as it is made in a mold, it can have a shape other than that of straight saw cuts. A sinter block can have indentations and protrusions, not unlike a lego brick, so as to stack snugly and in line, one over the other and in staggered rows. Sinter block will be easier to hand cut.

Make it Grand!

From crude and rustic to Romanesque or Gothic formality to almost spiritual simplicity and elegance, arches have been a favorite way of marking the entrance to a human settlement. Paris' Arche de Triomphe and St. Louis' Gateway Arch are examples of the variation.

A freestanding arch could mark the approach to the settlement main gate, or straddle the main road from the spaceport to the town. And what more refined material than hewn basalt, marking our ability to use lunar materials to state proudly, “we are at home!”

A new Stone Age

Does it seem odd that our initial efforts to use lunar materials will use a “stone age material? It is what we do with it that counts. Most of all, basalt is a material that is of the soul of the Moon. <MMM>

Shadow Pioneers

By Peter Kokh

You won't have to move to the Moon To become a Lunar Pioneer!

Until the lunar domestic economy is so well established that most products needed for consumption are produced locally, and until the settlements are producing enough exports to pay for what they must still import, the "wages" of lunar pioneers will be counted in terrestrial monetary units, as "astronomical" – e.g. \$100,000 per hour.

The best way to bring that figure down to size in the interim, will be to reserve for pioneers on location, what only someone on site can do. Conversely, a partnering crew on Earth, paid more down-to-Earth wages and salaries, will strive to push the limits of tele-operation and telepresence as far as possible so that the lion's share of routine chores on the Moon, including the lion's share of the most dangerous chores, will be done by machines under their control, with on site supervision.

Even in the Apollo days, mission crews on Earth magnified the efforts of the six pairs of moonwalkers, by monitoring their activities, analyzing problems and glitches, and brainstorming ways to survive unexpected emergencies. Having mockups on Earth of equipment on the Moon helped considerably, notably in getting the Apollo 13 crew home safely, against considerable odds.

It would not be misleading to say that the actual number of people on the Moon during each of those missions, counting virtual presence on a par with actual presence, was considerably larger than two! In that respect, these "shadow pioneers" have been somewhat under-appreciated. To say that the moonwalker duos stood on the shoulders of large teams on Earth would be an understatement.

This ratio of shadow pioneers to on site pioneers will continue, if not grow much larger and more varied in type of support offered, as we return to the Moon to set up a quasi-permanent hostel that can be revisited and eventually "built out" to a more fully functional size, as the seed of a first settlement.

In time, the first lunar settlement historians will recognize Earth-bound shadow pioneers as true Lunan pioneers. Those who go to the Moon and stay, and in time raise families there, will be just the frontline of a much greater population that should be revered as pioneers as well.

Many ways to help

Equipment operators

Perhaps a considerable portion of road construction, site preparation, and mining chores can be done remotely by teleoperators on Earth. The less than 3 second time delay in sensing a response to one's moves takes some getting used to, and some will master the trick much better than others. Indeed, if there was a legitimate place for child labor (without the long hours and low pay) this might be it. Young people have much more manual dexterity than adults, can more quickly and more easily master the game of anticipation needed to handle that time delay. To be fair, adults with a long history of electronic game playing going back to their youths, will score well to. It will help if in the kind of regolith-moving operations listed above, we can afford the slower pace of operating under the conditions of that time delay.

Agricultural Chores

Given an automation-friendly design, such as the torus-shaped greenhouse layout sketched below, where cultivating equipment circles around and around at any pace desired, much of that equipment could be robotic. But supervisory intervention from Earth could make any such system even more efficient, clearing jams, repairing or replacing components, etc. Yet the on location supervision needed should be minor.

By contrast, one of the badly designed aspects of the original Biosphere II experiment was that the 8 biosphereians had to spend most of their waking hours nurturing crops to

MMM Theme Issues: The Lunar Economy - Years 1-25 Dec 1986 - Nov 2011

harvest, without much time for anything else, much less time for recreation. Even so, they still all lost weight, manifesting all the signs of malnourishment. On the Moon, we need to avoid such labor intensive operations. It will be more important to reserve actual on location manpower in the production of products for export. Exports, to facilities and installations in GEO and LEO and other in-space markets, as well as to Earth's surface, will bring home the lunar bacon.

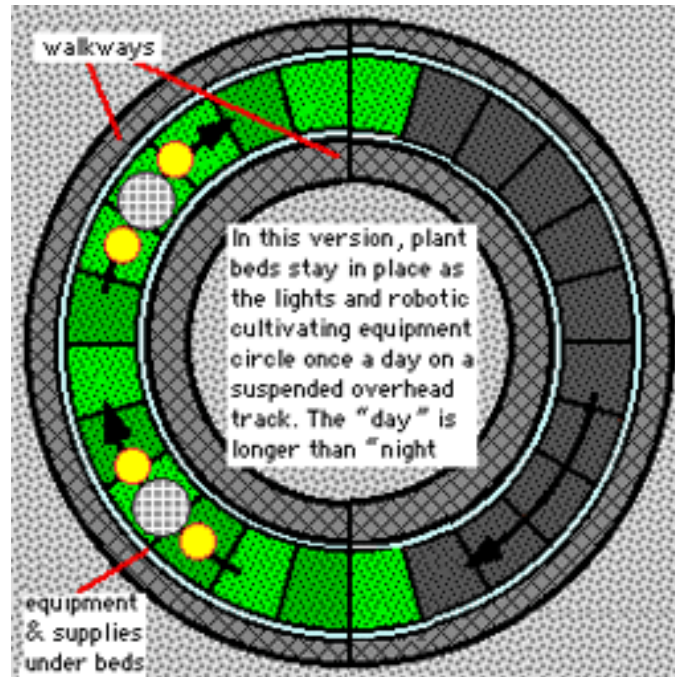

Teaching, tutoring, advanced education

Long before the arrival of the first native-born lunans, settler-pioneers will need to be continually up-grading their education, as needs evolve, and methods change. It will be far more efficient in the early years, to have the teachers, tutors, and trainers on Earth. A person on Earth can be supported (food, health, etc.) much more cheaply than individuals on the Moon, in the early years.

In time, as the settlements evolve with an ever growing portion of both youngsters and seniors, these things will change. Older people needing to slow down physically, may take on ever more educational duties. If Lunans retire to "half-time" instead of 100% free time, they could take on the lions share of parenting operations to free young parents for export-production chores. We already see, though for different reasons, the growing percentage of "grandparents raising grand-children." In the case of the lunar settlers, this will develop not as a result of more parents coming under the influence of drugs, etc. that for just plain economic sense. But we can expect that a significant amount of educating and tutoring will still be by telepresence, with on location assistants handling questions and problems.

Healthcare, nursing, medicine in general

This is one area where a high portion of work will be done by those on location. At the same time, ever more of diagnostic tasks will be done by computers. Interviewing patients, and channeling them to the right departments and many other preparatory work chores, can be more efficiently done by tele-presence.

Recycling

Sorting recyclable materials into the proper bins can be done by machines. Disassembly of products comprised of materials that need to be recycled separately is an area where computerized equipment can relieve a lot of people for other assignments. This presumes that all products will be assembled in a disassembly-friendly way (not with super bonding adhesives

MMM Theme Issues: The Lunar Economy - Years 1-25 Dec 1986 - Nov 2011

that lead to cross-contamination of dissimilar materials, a method that is “in” today.) Recycling equipment can be monitored from Earth, with a minimum of personnel on location on the Moon ready to intervene when needed.

Research and Development Facilities

When the mass of material being analyzed or used for experimentation is minor in comparison to the equipment needed, it will be cheaper to ship sample material “down the gravity well” to Earthside or orbiting facilities than to send all that equipment to the Moon. That may be the case early on, but as the population on the Moon grows, it will make more sense to do such research on location.

Field work: science and prospecting

It would seem to make sense that robotic or tele-operated equipment did the bulk of the scouting chores, while humans on location gave their attention to samples identified by the robotic equipment or terrestrial tele-operators as deserving special investigation. The final filter in what is significant and needs to be investigated further, is the human one. Artificial intelligence will probably always have its blind spots.

Other tasks done by people operating in settings less expensive to support

Automated stations would monitor the Sun for signs of approaching sunspots, flares, and coronal mass ejections. Humans on Earth would make the final judgments and alert pioneers on the Moon to take any special measures needed.

One could cite many more examples. The message here is that when some supporting task can be done on Earth without significant clumsiness due to the three second time delay, it will make economic sense to apportion tasks in that manner.

Many people on Earth will be involved in supporting roles in the epic drama of lunar settlement. To many of them, their contribution may be “just a job,” and they’d prefer collecting a pay check to accolades. But if Lunar pioneers are to be honest with themselves, they will be forever grateful to these cadres of assorted stay-at-home shadow pioneers.

Beyond the Moon

Will there be a similar Earthbound support group for the first waves of Martian Pioneers? Maybe, maybe not. Unlike the Moon which orbits the Earth in a fairly circular orbit, Mars and Earth both orb it the Sun each in their own orbits, with the distance between them varying from as little as 35,000,000 miles (140 times the Earth-Moon distance) to as much as 248,000,000 miles (a thousand times farther than the Moon.) As a result, the communications loop between the two planets varies from about 6 minutes to about 40 minutes – quite a bit longer than the less than 3 seconds separation between Moon and Earth.

We can teleoperate on Mars, but it is an excruciatingly slow process. If Mars was as close as the Moon, we could have driven Spirit and Opportunity over the same paths in weeks as opposed to years. So basically, we cannot really have the same kind of home planet – frontier teamwork as we expect to have on the Moon.

However, there is a way. If we were to set up logistical forward camps on Phobos and or on Deimos, crews there could teleoperate whole armies of small exploratory and prospecting probes in a relatively short time. Of course, such advance location crews would be vastly more expensive to maintain than the shadow pioneer crews on Earth.

This is a drawback and major impediment that confronts those who would settle Mars, that the more impatient Mars advocates (e.g. Robert Zubrin) want to push under the rug, if they consider it at all.

You can sum it up in three words: the Moon will develop a pioneer economy much faster than Mars, even though the latter world is blessed with more resources, because the Moon has the three most significant resources of all: “Location, location, location.” The Moon can be settled at the end of an umbilical cord. Not Mars.

Mars will need to a different plan, a mass assault by a very large and diversified contingent so that we have as many people on the ground as soon as possible. And with no

MMM Theme Issues: The Lunar Economy - Years 1-25 Dec 1986 - Nov 2011

possibility or umbilical cordlike resupply or rescue, they would have to bring with them along with a yolk sac of resources and supplies.

The unworkably long communications lags, and the very infrequent launch windows, 25+ months apart (vs. virtually anytime for the Moon), will require an all out effort right from the start, with little in the way of realistic exports worth the transport cost back to Earth for income. Solar Sail freighters can blow away the infrequency obstacle and luxurious cycling spaceships will make enjoyable the very long journeys either way. At ISDC 1994 in Toronto, this writer warned that despite all Mars' many plusses, all attempts to develop an economic case for Mars (Zubrin's rare gems, and special pharmaceuticals growing in Mars soil) are grasping at imaginary straws. A case can be made, but only by developing Mars and the Moon apace with three way trade. But we drift from our topic.

While many want in their impatience to bypass little Phobos and Deimos, they only cut their own throats. Patience pays off. Impatience usually backfires. Developing Phobos and Deimos in synch with the development of Mars surface settlements is the only rational plan. But irregardless of how those frontiers are opened, there will not be the same amount or scale of significant shadow pioneer contributions.

Productivity costs are not the only consideration

Safety is important also, and even further into the frontier future, when, as the lunar domestic economy grows to the point where labor costs are a lunar domestic matter and comparison with terrestrial labor costs have become meaningless, we will still be employing a high ratio of automated robotic and teleoperated devices on the Moon, for safety reasons.

NASA's experience with EVA (Extra Vehicular Activities), i.e. showed activities by personnel wearing spacesuits incur significant safety and fatigue risks. Mistakes that on Earth would be easy to dismiss in space and in vacuum in general, can easily become fatal or life-threatening. We will always want to minimize the number of suited individuals doing field- work of various kinds. There will be a difference, of course. Teleoperation will then be done locally, by pioneers inside pressurized environments, at whatever distance, without felt time delays.

Safety is not the only challenge. If we do not succeed in developing space/pressure suits that are more user-friendly, fatigue which is a definite factor in EVAs at the International Space Station, will continue to be an issue on the Moon. NASA and several contractors had been working on alternative suit designs, but funding for this work has been cut. Unfunded research continues at a low priority pace.

Will "Shadow Pioneers" appreciate their role?

It has been said that only 15% of people are fortunate enough to get paid for doing something that they really love to do. The other 85% do what they do because they have to earn money somehow. "It's just a job!" Undoubtedly, to many "shadow pioneers" their work will indeed be just another job, and many will care less how much their work may be appreciated by on location lunar pioneers. But in fact, it will not just another job, and we predict that the ratio of personnel involve who get extra satisfaction from the realization of how important their work is, will be on the high side.

Pioneers on the lunar frontier, however, may well better appreciate the efforts of shadow pioneers. Indeed, it would not be surprising if future frontier calendars listed a "Shadow Pioneer Day" with possible holiday status. So why don't we in America have a day of appreciation for all the pioneers who helped lay the foundations for the freedom and prosperity we all enjoy? Maybe that is a separate issue to pursue.

Conclusion – Teleoperation and telepresence will play significant roles in the opening of the lunar frontier and the spread of a global human presence there. On Mars they could play a role, but a less important one. After the Moon, the most promise lies in teleoperating equipment landed on Earth-approaching asteroids.

Teleoperators will be shadow pioneers, doing invaluable service. They will allow fewer people actually on the Moon to get more work done at less cost, and just as importantly, at less

MMM Theme Issues: The Lunar Economy - Years 1-25 Dec 1986 - Nov 2011

risk. They will be true lunar pioneers, even though they may remain out of the public eye. But if the frontier effort is successful in establishing a viable Earth–Moon economy, their work should be long remembered. **MMM**



This 5" long rock is rich in KREEP: Potassium (K), Rare Earth Elements (REE) and Phosphorus (P)

These elements are rare on the Moon but abundant in the splash-out from the impact that created Mare Imbrium, the nearside “Sea of Rains” – This resource may be vital to lunar industries.

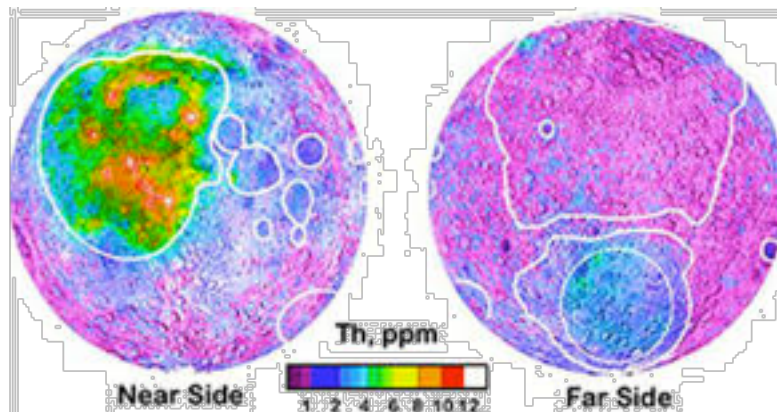

This is a map of Thorium distribution on the **Nearside** (concentrated in **Oceanus Procellarum** (mare area) and **Farside** (concentrated in the **South Pole Aitken Basin (SPA)**). Thorium is generally considered a “tracer” for KREEP deposits. On the Nearside, you will notice the orange ring that surrounds Mare Imbrium (in aqua shade) and this is the Mare Imbrium impact splashout zone. There is also a high concentration (orange) below Mare Imbrium in the southern part of Oceanus Procellarum.

More on KREEP:

<http://en.wikipedia.org/wiki/KREEP> – <http://www.lunarpedia.org/index.php?title=KREEP>

For practical purposes **Potassium** and **Phosphorus** will be very important in the production of materials we will need to build a lunar civilization.

More on Potassium K

<http://en.wikipedia.org/wiki/Potassium>

MMM Theme Issues: The Lunar Economy - Years 1-25 Dec 1986 - Nov 2011

<http://www.umm.edu/altmed/articles/potassium-000320.htm>

<http://wanttoknowit.com/uses-of-potassium/>

More on Phosphorus P

<http://en.wikipedia.org/wiki/Phosphorus>

<http://wanttoknowit.com/uses-of-phosphorus/>

But there are many important uses of the various Rare Earth Elements as well:

Samarium, Europium, Gadolinium, Terbium, Dysprosium, Holmium, Erbium, Thulium, Ytterbium, Lutetium, Scandium, Yttrium – http://en.wikipedia.org/wiki/Rare_earth_element
MMM

MMM # 221 December 2008

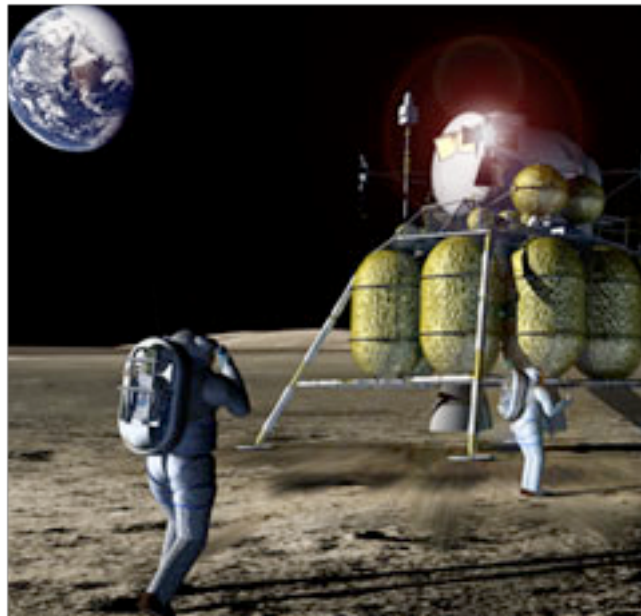

Investing in Fuel Tank Infrastructure in the Architecture of Lunar Exploration

By David Dunlop dunlop712@yahoo.com Moon Society Director of Project Development

Background

At the ICEUM* 10 Conference Dr. Harrison Schmidt made a comment made about the NASA Altair Lunar Lander s having a proposed ascent system using hypergolic fuels. His concern was that reliance on a hypergolic fuels system would strategically preclude the subsequent use of in situ produced fuels such as liquid hydrogen and liquid oxygen. [* International Conference on the Exploration and Utilization of the Moon]

The ability to produce in situ fuels is one of the major strategic objectives that will enable the scientific exploration and utilization of the Moon. Dr. Schmidt was reinforcing a view shared by many in the Space Resources Roundtable and the Moon Society that oxygen production should be one the highest strategic priorities of the technology development roadmap. The discovery of concentrated ice deposits in the polar cold traps would accelerate this possibility by refueling both hydrogen and oxygen tanks as well as storing water.

The technology roadmap currently involves a demonstration goal of producing 1 ton of in situ oxygen. (1) Few would argue against the proposition that one ought to crawl before one

MMM Theme Issues: The Lunar Economy - Years 1-25 Dec 1986 - Nov 2011

walks, but by the same token it is important to look strategically at the plans for use of landed assets, or the lack thereof, and try to eliminate roadblocks to more rapid utilization of in situ resources and of use of infrastructure for a variety of exploration, research, and commercial purposes.

The strategic roles of tank infrastructure NASA's Tank Contribution The NASA's Vision for Space Exploration has resulted in a lunar exploration architecture that results in three Ares V missions to the Moon per year beginning in 2020 in the build up of a lunar outpost. (2)

Each Altair lander descent system will leave 4 oxygen and 4 hydrogen tanks on the lunar surface with a capacity of 27 tons. Thus, each year, 12 oxygen and 12 hydrogen tanks with a combined capacity of 81 tons are delivered to the surface. Between 2020 and 2025 some 18 landers will be left at the lunar outpost with a total tank capacity of 1,458 tons. (3)

ESA Tank Contribution NASA has also been coordinating the development of its Constellation architecture with ESA so that there can be a complimentary effort. ESA is now studying development of a lunar cargo lander, based on the commercial Ariane V launcher, with the capability to deliver 1.2 tons to the lunar surface. Such ESA cargo landers will presumably also deliver a significant set of oxygen and hydrogen tanks to the lunar surface.

The other spacefaring members of ILEWG: CNSA, ISRO, JAXA, ROSCOSMOS, will similarly deliver tanks to the lunar surface with their landers. One hopes that similar efforts to coordinate the development of the lunar exploration architecture of these agencies in a mutually advantageous manner can occur as ISRO, JAXA, ROSCOSMOS, and CNSA etc. lay out their technology development roadmaps.

Valuing Tank Infrastructure

The value of these tanks is their necessity in getting to the lunar surface in the first place. Secondary utilization of these tank has great strategic importance. These empty tanks are potential beginning elements of commercial, industrial, and research infrastructure on the lunar surface. Potential uses include:

The fuel tanks, if refueled could potentially enable the reuse of an Altair vehicle. The capacity to refuel and reuse an Altair could enable sortie missions across the lunar globe. A number of such vehicles would also make for a redundant capacity for exploration or rescue of human crews on extended treks if needed.

The tanks if refueled can provide a "back-up" source for life support gases for habitation at the lunar outpost. These tanks could provide an operational reserve for crews whose life support systems failed or where some catastrophic accident has occurred with primary supplies. This reserve could buy the crew the time needed for a rescue attempt.

The tanks if refilled might provide refueling of other vehicles as a "lunar gas station." This fuel capacity serving all space faring nations involved in landing at a lunar outpost could provide the beginning of commercial activities on the Moon.

ILEWG could develop a collaborative model of the lunar supply chain to the lunar outpost involving all of the launchers and landers of its members. A whole systems model of fuel demands and of fuel storage on the lunar surface might be developed. This model could then "inform" the design of common service and support facilities.

A "**Lunar Port Authority**" could serve as the purchasing agent and thus acquire its "tank farm" from national space agency transportation providers. A Lunar Economic Development Authority (LEDA) could be a target of private investment capital in the creation of servicing facilities that facilitate both national missions and private lunar activities such as lunar tourism or commercial research. This type of model would allow a LEDA to create habitation facilities, and private laboratory facilities utilizing the BA330 units being designed by Bigelow Aerospace or possibly lab modules already flown on the shuttle by SpaceHAB, as well as tank farms and refueling facilities.

These considerations would be a proper issue for ILEWG to discuss as a matter of developing inter-operability standards and hardware for gas exchange systems and tank farm

MMM Theme Issues: The Lunar Economy - Years 1-25 Dec 1986 - Nov 2011

infrastructure. The tanks might be used for storage of other in situ volatiles that would result from an end-to-end demonstration of processing in situ materials.

The designation of the ISS as a national lab facility by the US provides a powerful precedent for the creation of dedicated laboratory facilities at a lunar outpost. It would be logical to expect nations with human lunar programs to extend their program by adding research facilities just as has happened with both ESA and JAXA on the ISS. Tanks that have been used as part of a transportation architecture might also with modification do secondary duty in curation of lunar samples. They might provide a mechanism for transport of lunar samples (when fully purged) preserving the vacuum environment on return to Earth or as elements of a curation system storing lunar samples brought back to the lunar outpost in a sealed “protective” container to maintain their pristine condition in a curation environment on the lunar surface.

These tanks could be sold to the LEDA authority or another commercial entity thus recapturing a significant share of the capital invested in the transportation services. This secondary market for the tanks could therefore reduce the cost of transportation services. It also provides “price points” for those wanting to model the cost of acquiring lunar infrastructure and of the investment requirements of a lunar surface market.

There are no doubt other uses that can be suggested for these tanks. Dr. Schmidt's concern's only underscores the importance of taking these varied considerations in mind in the beginning engineering design of the tanks themselves and of identifying the secondary markets for these tanks.\

No More Missed Opportunities for Commercialization

There were many suggestions over the years for the use of Space Shuttle tanks in LEO but no action was taken by NASA perhaps because no credible near term market existed for their use. Perhaps it is easier to envision many secondary uses for these tanks on the lunar surface in conjunction with growth of a lunar outpost. These secondary uses would represent the next enabling stages of the evolution of a lunar outpost into a lunar base.

Groups such as the Space Resources Roundtable, and LEAG, should consider the needs of the in situ resource research community for tankage as part of defining a laboratory facility capability for in situ research and demonstration. This definition should also information NASA's commercialization initiative and the need to develop both contractual and legal frameworks for secondary tank utilization. The design and engineering work of the Altair should “set up” the infra-structure of secondary utilization.

The same recommendation is made for ESA lunar cargo lander and other members of ILEWG and OSEWG that are landing on the lunar surface. (1) (2) (3) **DD**

PARADIGM SHIFT

Editorial Commentary on the Article Above

By Peter Kokh

We wholeheartedly endorse the proposal of David Dunlop that fuel tanks on the proposed Altair Lunar Lander, and all other craft being designed to land on the Moon, be designed for reuse on the Moon.

We have, in fact, called for the design of all lander components not returning to space, to be pre-designed to serve other “post-consumption” needs on the Moon. See our article “Thinking Outside the Mass Fraction Box, I” in MMM #209, reprinted above.

MMM Theme Issues: The Lunar Economy - Years 1-25 Dec 1986 - Nov 2011

We also touched on this design mandate in our series, "The Outpost Trap," particularly in Part I, MMM #198, September 2006. This series is reprinted above.

Dave has shown his paper to a number of notables inside and outside of NASA with very mixed results. Those coming from industry in general had a positive reaction, those from NASA, nothing but criticism. That's to be expected.

The problem is that NASA's eyes are focused on its narrowly defined mandate: to place an occupiable camp site (not an occupied moon base) on the Moon. Any money, however trivial, spent on tweaking a component's design so that it has some future use in a scenario of expanded operations cannot be considered.

Of "ladders and rungs": a lesson from ISS

This kind of thinking, looking at each "rung" in a ladder as an end in itself risks creation of a "rung-like" entity that does not lead to a next "rung." Witness the International Space Station, put by political compromise in a high inclination orbit that precludes its usefulness as a depot or staging point for deep space missions. The Station's only use is for Earth Observation. ISS is the pride and joy of "yo-yo space" or reflexive space or intransitive space. That is not to downplay its usefulness as such. But those of us who lobbied long and hard to realize von Braun's "stepping stone to space," got something quite different than what we wanted.

NASA mission planning and architecture is the miscreant pride and joy of a budget process that is incapable of looking forward. And those of us who waste our time lobbying Congress to do this and that do just that, "waste time."

The need for a "Paradigm Shift"

We need a paradigm shift, one designed to keep the ladder in mind, tasked with designing every rung to be pregnant with the next rung, and on and on. To get that shift, we have to widen the list of players. NASA and the US Government are useful, but cannot alone deliver, and must not even be allowed to play "the" anchor tenant role.

Thinking beyond NASA

We need to bring into play the space agencies of other nations: ESA, Russia, China, India, Japan, and others not yet at the table. But we also need to bring industry and enterprise, not just as "under contract" but as contractors and service providers, who will someday build their own facilities on the Moon to serve the various international agencies, enterprises such as tourism, mining operations, science installations, and more yet unforeseen.

Once we are talking cooperation between a number of agencies, a number of contractors, and a number of service providers, the logic of cheating the "Mass Fraction" limit on launched payloads, by designing every component needed for the journey to the Moon, for an after-life service on the Moon. That way, the "landed payload mass" includes not just habitat and needed equipment, but every last bit of the non-returning lander consist - tanks, struts, winches, plat-forms, legs, pads, ladders, cargo holds, and so on.

A lesson from poverty

Among the poor, the culture of using everything, and wasting nothing, is well known. In cooking a pig, one uses "everything, but the squeal!" Because building and expanding operations on the Moon will always be more, much more, expensive than similar operations on Earth, we must adopt the same philosophy, of "using everything but the squeal." Every item we can reuse is an item we do not have to pay to ship from Earth. Its freight was paid for in the shipping charges for the cargo per se.

"Making every step pregnant with the next" will lead to a timely, "inflationary" expansion at an ever accelerating rate. For NASA to create an industrial settlement on the Moon, one self-limited step at a time, could take centuries. If we shift the paradigm, we could have the start of a settlement within a decade of our first crewed return to the Moon. This will be inconceivable to those whose minds have become imprisoned in NASA-Congressional-Budget-Process-culture.

The Paradigm must shift not only as to what we define as "landed payload" on the Moon, but as to the current dismissal of the benefits of "leveraging" that come from refueling along

MMM Theme Issues: The Lunar Economy - Years 1-25 Dec 1986 - Nov 2011

the way and taking anything that could conceivably be reused to the next platform level: LEO, GEO, L1, LLO etc.

NASA dismisses “refueling” and “fuel depots” as inefficient. Yes, if you are only looking at one mission, or a very limited series of missions, rather than an every growing and evolving “inflationary” build-out of operations on the Moon. Change the goal, and the equation changes with it. If NASA will not or cannot change its concept of the goal (each rung as an end in itself, not necessarily leading to another rung), then NASA must be demoted as “the player” to the status of “a player.”

The Moon Society’s role

At the top of our homepage there is a declaration that we were “formed to further the creation of communities on the Moon involving large-scale industrialization and private enterprise. Following the link, we are pledged to complement “NASA initiatives and goals by looking for alternative options to advance research goals NASA is no longer able to undertake.” Not all of our members are aboard yet, but our role is clear. <PK>

Raw Glass: A near-term, ready to go Lunar Technology



At right: a chunk of raw black glass made somewhere in the Middle East. On the Moon, we could take the regolith as it is, highland and/or mare, heat it until it becomes liquid then shape it. Well mixed, the product would have a uniform color in the light to dark gray range. Unmixed, it might have a characteristic variation. Contribution of orange volcanic glass, and only partially melted small breccia bits would make the product interesting. Crude but durable, raw glass production could provide settlement tableware as well as, flower pots and vases and objects of art. Using this near term technology to “lunarize” our living spaces, we will start to feel “at home.”

Read “Making Glass on the Moon” and the following article pp. 54-55

http://www.moonsociety.org/publications/mmm_classics/mmmc16_July2007.pdf

MMM # 224 April 2009

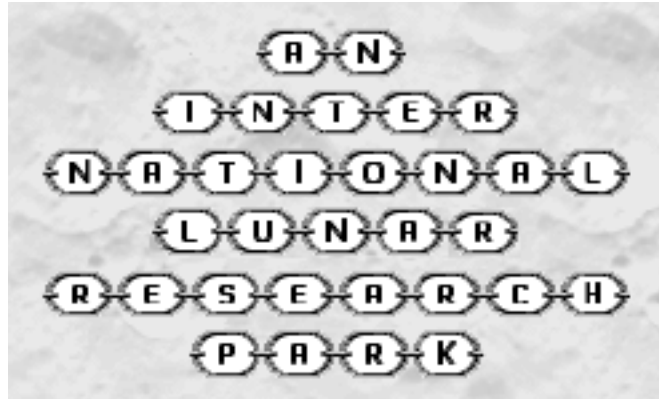

An International Lunar Research Park – ILRP An Open-ended Lunar Initiative v. 2*

By Peter Kokh and David Dietzler

V.1 published in MMM-India Quarterly (Feb. 2009)

http://www.moonsociety.org/india/mmm-india/m3india2_Winter09.pdf

Current Prospects

The United States, under former President George W. Bush, redirected its ISS and Planetary Exploration-focused Space Program to a “return to the Moon” and “beyond to Mars.” This direction will probably continue under President Barack Obama. Meanwhile, China, India, and Japan have launched lunar probes and spoken of putting crews on the Moon. Whether these will be one time “science picnics” à la Apollo or real efforts to establish permanent facilities to support manned exploration sorties and other activities remain to be seen.

The Question

If each nation picks a different location on the Moon for its surface activities, areas of cooperation are limited to data sharing, tracking, and other support activities.

If, however, some or all national lunar outpost efforts are concentrated at one and the same location, be it at the north or south lunar poles or somewhere else, then the opportunities for shared facilities is enormously increased, and with it could come major savings by reducing unnecessary duplications.

Shared Facilities: Corporate Partners

Of course, then the question becomes “who will build and provide the facilities to be shared? And right here we have the opportunity to introduce new parties: contractor companies. Possible contractors could include Boeing, Lockheed-Martin, EADS, Antrim, and other names associated with the Aerospace industry, but also other major contractors. To pick a few: Bechtel, Halliburton, Mitsubishi, and on and on.

Added Players: Enterprise, University Consortia

If we collectively choose to establish not a collection of national outposts, collocated or not, but an “**International Lunar Research Park**” the possibilities for future expansion, elaboration, and outgrowth – even into the 1st human lunar settlement – will increase greatly.

Facility Lists

The lists below are meant to show how great are the possibilities for diversification and outgrowth. The items in **bold** will come first. Plain type next, italics last. Note, that this sub-classification is just one person’s first attempt, and corrective input is most welcome. No one expects to “get it right” the first time! What we want to do is to put out the general concept of how enormously the choice of an International Lunar Research Park could bust the future wide open. After the itemized lists (we surely have forgotten or not thought of many items!) we will give our thoughts on just what must come first.

MMM Theme Issues: The Lunar Economy - Years 1-25 Dec 1986 - Nov 2011

National Outpost “Core” Elements

- **Base habitat**
- **Base laboratories**
- **Basic life support**
- **Command center**
- **Airlock**

Contractor Corporation Services

- **Site preparation**
- **Spaceport services**
- **Construction equipment**
- **Shielding services**
- **Solar wind gas scavenging**
- **Fuel storage**
- **Fuel production**
- **Power generation**
- **Power storage**
- **Warehousing systems**
- **Thermal management**
- **Waste treatment**
- **ISRU Research**
- **ISRU Manufacturing**
- **Habitat expansion modules**
- **Agricultural modules, basic agricultural services**
- **Biosphere maintenance**
- **Road construction**
- **Connector modules**

Enterprise Opportunities

- **Commons with meeting space**
- **Restaurant(s), pub(s)**
- **Recreational facilities:** exercise, sports, dance, theater
- **TV/Radio Facilities, satellite communications telephone system, internet provider**
- **Instruction, continuing education** – keeping up to date with improved lunar systems
- **Financial services**
- **Hotel facilities** for visitors, tourists, overflow between crew changes
- **Cabbotage** (outfitting) services
- **Surface transportation (passenger, freight)**
- **Vehicle maintenance**
- **Space suit services**
- **Tools, equipment**
- **Recycling services**
- **tour coaches & excursion services**
- **marketplace**
- **agricultural production, products**
- **green (horticultural) services**
- **reassignment services** (new roles for scavenged parts of landers etc.)
- **agricultural production**
- **customization services**
- **event management**
- **surface recreation vehicles**
- **archiving services**

University Consortia

MMM Theme Issues: The Lunar Economy - Years 1-25 Dec 1986 - Nov 2011

- **Medical Center**
- Continuing education
- Research facilities
- Astronomy installations

Joint Civic

- **Road planning local**
- **Road planning regional**
- **Environment protection**
- **Environment enhancement**
- **Inter-Sector coordination** (Contractors, Enterprise, National, University)
- Parks, parkways, gardens
- Outstation planning

Discussion – where you come in!

It would be miraculous if the list above did not have many holes, even if nothing was misclassified. Your input is most welcome!

The effort above is an attempt to start a discussion and to keep us, nationals of the various countries contemplating lunar surface activities, from being blind-sighted to the enormous advantages to be gained not only by collaboration between the various national agencies, but by restraining agency hubris and by taking the plunge to invite corporate, enterprise, and university consortia as equal partners in a joint “human” effort.

The idea is for the national outpost agencies to buy or lease or tent equipment and services from the contractors and enterprises as their needs change and expand. This should provide not only substantial cost savings but a greater variety and supply of equipment and services.

Agencies need not provide quality and other specifications, because corporate and enterprise personnel would be just as much at risk from improperly designed and manufactured equipment as would national agency crews. Toss out the mind-boggling bureaucratic paperwork, and down comes the costs.

Corporation employees would need housing, and all the other life support services as needed by the agency crews so it is natural, that as they begin to construct pressurized modules and other equipment from lunar building materials that they could provide for expansion of national outposts as well at considerable savings.

The national outposts would be “anchor tenants” so to speak, but as in shopping malls, in time their share of the economic value of total activities and facilities at the site might become, even though essential.

Some sort of Civic Council representing all of these Parties would be needed to make decisions that affect every-one, decisions about growth directions, environmental safe-guards, and so on. As this unfolds, the International Lunar Research Park will have become the first lunar settlement!

It is time for humanity to open the next continent, one across a different kind of sea. The “out of Africa” effort is ready for the next act. Only humans as a species, not horse-blinded agency managers, have the vision to grasp what is needed – and it is not a collection of agency outposts!

What Comes First?

Frankly, national agency planning puts the cart before the horse. Why?

Two things come first, and no one is giving either of them more than trivial attention.

Part I: Developing now the Technologies needed for using lunar resources

We are not going to anything of lasting significance on the Moon unless we learn how to process useful building materials out of the elements in moon dust. Known by the uppity Latin term “In Situ” Resource Utilization (“on location” works just fine!) various processes have been proposed to isolate oxygen and other elements, but few have been tested either in laboratory scale or (more importantly) in mass production scale. How do we advance the “readiness” state”

MMM Theme Issues: The Lunar Economy - Years 1-25 Dec 1986 - Nov 2011

of these technologies? It is important to have them ready to go when we land on the Moon. Getting there, and then having to scratch our heads for additional time-wasting decades makes no sense. But that is the path we are on.

This topic is the subject of “**Improving the Moon Starts on Earth**” in MMM #s 132,133, Feb/Mar 2000. Reprinted in MMM Classics #14

http://www.moonsociety.org/publications/mmm_classics/mmmc14_July2006.pdf

Part 2 – Site Development

No site on the Moon, no matter what advantages are touted on its behalf, is anything but “unimproved” land, what in might be called “Florida swampland.”

Before the first national agency manned lander sets down on a chosen site, it makes sense for a corporate contractor to have already “improved the site” – conferring on it various advantages that will make outpost deployment, construction, and operation so much easier. Indeed, Carnegie–Mellon University, a contestant for the Google Lunar X–Prize, has just proposed that establishment of the first spaceport be contracted to the university to be done by telerobotics.

www.post-gazette.com/pg/09063/952880-115.stm

This is the subject of the article, “**The Developer’s Role**” from Moon Miners’ Manifesto #131, December 1999.

Both articles are combined in one Online Paper:

“Improving the Moon & the Developers Role”

http://www.moonsociety.org/publications/mmm_papers/improving_moon_paper.htm

Also relevant, “The Outpost Trap” serialized in MMM #s, 198, 199, 200 September, October, November 2006 – reprinted above

<PK/DDz>

Lunar Research & Development Priorities List: 1–5

By David Dietzler – pioneer137@yahoo.com

- 1a) **Space Transportation:** cheap access to space – CATS, from inexpensive expendable and/or reusable Earth to LEO launchers to ion drive or sail propelled craft for transport from LEO to LLO, L1, etc.
- 1b) **Lunar derived fuels / propellants** for lunar landers after some initial development on the Moon. Ion drives and sails are only good for cargos, not manned craft, given the great length of time they require for travel to LLO and therefore exposure to Van Allen Belt radiation, as well as life support. Thus we also need orbital fuel depot infrastructure. The cost barrier must be broken.
- 2A) **Life Support Systems** for prolonged (months, even years) human stays in space
- 2B) **AI robotics** for the majority of work done in space
- 3) **Production of oxygen**, other gases, metals and ceramics from lunar materials (some of this is included in category 1, for the production of rocket propellants on the Moon, given the assumption that lunar derived fuels will be cheaper than boosting them from Earth to LEO, although this assumption might be challenged depending on how much infrastructure on the Moon and in space would be needed, when it would be needed, how low the cost of launching to LEO goes, and how many manned flights would be called for given that robot power not manpower will do most of the work

Lots of research has been done on Oxygen production and most of it has been done with simulants only on laboratory bench top scales for short periods of time. Much more research must be done with real regolith using equipment that is built to work in vacuum, low G, hard radiation and temperature extremes for extended periods of time–years, not just weeks

MMM Theme Issues: The Lunar Economy - Years 1-25 Dec 1986 - Nov 2011

or months. Understanding the chemistry of regolith refining is just square one. A vast amount of R&D is required to build the equipment that does the work from shovel to final product and to determine which processes will scale up from the lab bench to the industrial level, work reliably for years in the lunar environment, demonstrate the greatest economy in terms of labor, time and energy required; require the least amount of input from Earth (some processes will require chemicals from Earth that must be carefully recycled) and the most amount of "Moon-makeability." We will need to replicate this equipment on the Moon from lunar materials to expand production rather than constantly import devices from Earth hence the need for "Moon-makability" otherwise the cost of ISRU will be too high.

Prerequisite to production of lunar materials is energy production. It's going to take a lot of energy to smelt or refine regolith so we will have to land substantial payloads of reflectors, concentrating lenses or mirrors, solar panels, batteries and/or fuel cells and fuel cell reactant storage equipment, cables, switches, inverters and possibly small nuclear reactors. We will need to expand energy production as materials production grows and this takes us to the next category:

4) Lunar manufacturing: what to make and how to make it as well as what to make it from.

Once we get past the hurdle of producing gases, metals and ceramics on the Moon we have to figure out how to make more devices for producing them from the gases, metals and ceramics available on the Moon. It won't be much use if the regolith refining devices require large amounts of gold, copper, zinc, fluorine or other elements from Earth. We cannot support huge masses of equipment, even with what passes for "cheap access to space" in the future, because even CATS will still be expensive compared to transportation on Earth. We must support a seed of regolith refining and manufacturing devices that can replicate itself in order to refine more regolith and produce more materials as well as make things from those materials like solar panels, power storage systems, habitat, farm modules, robots, vehicles, machine tools and mass drivers for launching millions of tons of lunar materials into space for SPS construction.

To grow the mighty tree of space industry on the grand scale envisioned ever since O'Neill wrote "The High Frontier" from a tiny seed amassing perhaps just hundreds of tons will require a lot of brainpower, real world experience, and some sophisticated AI robot software as well as hardware. At this time even the experts can only take shots in the dark as to what that seed will consist of. It's fun to speculate about the payloads this seed might consist of, but only after some extensive R&D on the ground and on the Moon during NASA's RTM program and some high paid teams of mission planners have had years to work on this will we know exactly what the lunar industrial seed will consist of. Because of the high price of even CATS in the future it will be essential to minimize the mass of the lunar Industrial seed machines, maximize the use of local materials, and maximize the lifetime, durability and efficiency of the seed. Also, the seed must be reasonably priced. What good will it be to use a one-ton machine that costs a billion dollars if a ten ton machine can do that job and be transported to the Moon for much less than a billion dollars? In other words, when does miniaturization start costing more than rocket transport?

As for nanomachines, I have no doubt that nano-technology will be involved in lunar industrialization but I don't go as far as suggesting that a few kilograms of nanobots will replicate like a growing algae bloom and lunar colonies will emerge from that. I do not have anything against that scenario, I just don't buy it. I would love to be wrong but I suspect that lunar industrial seed will amass several hundred to several thousand tons and even that will be tiny compared to the millions of tons of lunar industry and SPSs that emerge from that over time.

5. Space construction. We have never built anything as large as a solar power satellite in outer space. What will it take to do this? We can presume that lunar aluminum, silicon and titanium, possibly some steel and glass, will be used but how will billets of metal from the Moon be turned into SPSs? What machines will be needed? How do we get those machines in

MMM Theme Issues: The Lunar Economy - Years 1-25 Dec 1986 - Nov 2011

space? Launch them from Earth or make them on the Moon and launch them from the Moon or will a combination of Earth launched and Moon made/Moon launched machines be used? Will we need a space colony and 10,000 space workers or will we just station a small human crew in space and use thousands of robots teleoperated by humans on Earth and on the Moon?
DDz

Magnesium & Iron Lunar Workhorse Metals

By Dave Dietzler pioneer137@yahoo.com

Outside of Convention

The literature contains many descriptions of processes for extracting aluminum and titanium from lunar regolith. Space colonies and solar power satellites have been designed that use these metals primarily. I will not elaborate on the processes for getting aluminum and titanium here. For the curious, see:

www.nss.org/settlement/ColoniesInSpace/colonies_chap07.html

and www.nss.org/settlement/nasa/spaceresvol3/plsoom1.htm

The difficulty with these processes is that they require substances not too common on the Moon like sulfur, hydrogen, sodium, carbon, chlorine, fluorine and/or lithium. There are lunar sources for some of these like troilite, FeS, of meteoric origin for sulfur that is sprinkled throughout the regolith. Hydrogen and carbon can be obtained by mining and roasting millions of tons of regolith. Sodium should be found as an impurity in oxygen from molten silicate electrolysis. Chlorine could be obtained by mining and roasting millions of tons of pyroclastic glass. Fluorine and lithium are especially rare on the Moon. Although aluminum and titanium production will not be impossible, this will be limited by the number of times upported reagents can be recycled and by leakage losses. It will also be limited by the quantity of reagents that can be produced by mining and roasting huge amounts of regolith and volcanic glass.

Magnesium and iron are two metals that can be obtained on the Moon with processes that use only substances common and easy to get.

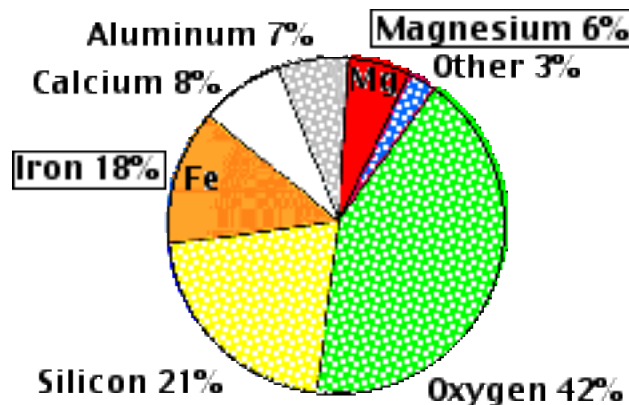

Relative abundance of Iron & Magnesium in Lunar Crust

Magnesium

This metal might be overlooked because it is somewhat soft and burns; however, in a vacuum it will not burn and in air it is only likely to ignite if powdered or fine parts are being machined. Machining could be done in inert gas filled work chambers. As to its softness, it can

MMM Theme Issues: The Lunar Economy - Years 1-25 Dec 1986 - Nov 2011

be used for applications that don't demand a high degree of hardness and it has a very high strength to weight ratio that makes magnesium at times more desirable than aluminum or steel. Magnesium could be used for jobs that we might conventionally choose to use aluminum like railroad cars, rockets and spacecraft, ground vehicle frames and pressure cabins, and solar reflectors and supports. It is a slightly better reflector than aluminum.

On Earth magnesium is used for many products like auto body parts, wheels, engine parts, gear boxes, and sports equipment, for which light weight is an advantage. Baseball catchers' masks, skis, race cars, and horseshoes are made with magnesium alloys. Consumer goods such as ladders, portable tools, electronic equipment, binoculars, cameras, furniture, and luggage also benefit from magnesium's lightweight, and other applications make use of its ability to absorb vibration. It could be used on the Moon for these as well.

Magnesium can be welded with electric arcs and a helium shield gas. In the vacuum a shield gas won't be needed. Lasers are also good for welding magnesium due to their low heat input. It can also be cast in plaster molds, extruded and hot rolled. Magnesium alloys usually contain zinc, zirconium and aluminum. Zirconium might be hard to produce on the Moon, but some zinc can get obtained from pyroclastic glass and some aluminum should also be available. Rare earth elements from KREEP can also be used to alloy magnesium.

Mg could be extracted by removing magnesium olivine, forsterite (Mg_2SiO_4), from regolith with electrostatic separators. Magnesium oxide could also be gotten by roasting regolith at 1500 C° +[1]. The olivine or MgO could be reduced with silicon in a flux of lime or calcium aluminate. Silicon or ferrosilicon can be obtained by serial molten silicate electrolysis. Calcium aluminate can be gotten by roasting anorthite or highland regolith at 1500 C° +. This silicothermic reduction process is most popular today and has replaced electrolysis of magnesium chloride for the most part. It is done at a temperature of about 1500 C° in a vacuum. The magnesium boils off and is condensed in the form of masses of metallic crystals. Solar or electric furnaces for this process could be made of cast basalt or glass bricks. Ceramic from magma electrolysis might also be used. The furnaces could be lined with titanium dioxide bricks because of their high melting point. The bricks could fit together like lego blocks and they would be welded tight with microwaves or electron beams.

Iron

Pure iron can be obtained on the Moon by magnetically harvesting meteoric fines that compose 0.15% to 0.5% of the regolith and are 5% nickel by mass [2]. Iron can also be gotten from serial magma electrolysis. Earthly cast iron is 3.5% carbon and is very brittle. Wrought iron is basically pure iron and these will have similar characteristics. Wrought iron has 40,000 psi tensile strength and 40,000 psi compressive strength. This may not be very high compared to steel and alloys of steel, but it is higher than that of unalloyed aluminum or magnesium. Before blast furnaces and Bessemer convertors wrought iron was the primary structural metal. So lunar pure iron should be respectable.

Rivets, nails, chains, railway couplings, water and steam pipes, nuts, bolts, handrails, roof trusses and ornamental ironwork were once all made of wrought iron. It was also used to make iron plates suitable for boilers. Blackplate consisted of sheets of iron thinner than plate iron [3]. To conserve carbon on the Moon, sheet iron instead of steel could be used to make studs for hanging cement board or drywall for walls inside lunar habitat.

Pure iron might be converted to limited amounts of steel on the Moon by using the old blister steel or cementation process, since blast furnaces and basic oxygen furnaces on the Moon are out of the question. Sheets of iron with carbon sandwiched in between or iron rods packed in carbon can be heated until they are cherry red in furnaces made of stone, cast basalt or ceramic. After several days the iron will absorb enough carbon to become steel. The steel is removed and melted down, perhaps with some calcium aluminate flux to absorb sulfur impurities, then cast and/or rolled. Carbon would come from scavenging of millions of tons of regolith. At the University of Wisconsin a Mark 3 mining robot has been designed. It could produce about 80 tons of carbon a year as well as substantial quantities of hydrogen, nitrogen

MMM Theme Issues: The Lunar Economy - Years 1-25 Dec 1986 - Nov 2011

and helium. Most lunar carbon will be used for biospheres, but if we devoted just 10 tons of carbon to steel production it would be possible to produce 1000 tons of 1% high carbon steel. This steel would be reserved for special applications like nuts and bolts, tools, cutting blades, drill bits, bearings and perhaps mining shovel buckets.

Works Cited

- 1) Rudolf Keller & David B. Stofesky of EMEC Consultants
"Selective Evaporation of Lunar Oxide Components" reported in
SPACE MANUFACTURING: 10 PATHWAYS TO THE HIGH FRONTIER
Proceedings of the Twelfth SSI-Princeton Conference May 4-7, 1995; pg. 130.
- 2) www.nss.org/settlement/nasa/spaceresvol3/lunarben1b.htm
- 3) http://en.wikipedia.org/wiki/Wrought_iron

[Editor: also see: MMM #118 SEP. '98 p 8. MAGNESIUM: Workhorse Metal for Europa, P. Kokh, D. Dietzler
republished in MMM Classic #12 p. 61]

MMM # 229 October 2009

Resources of Mare Imbrium and Oceanus Procellarum

By David Dietzler 2009

The Ocean of Storms and Sea of Rains offer interesting possibilities for resource utilization on the Moon. These resources might be of great value to lunar and Earth orbital industry as well as Mars colonization in the future.

1) KREEP terrain: [Potassium (K), Rare Earth Elements, and Phosphorus (P)]

Some of the richest KREEP terrain exists around the rim of the Sea of Rains (Mare Imbrium) and in the Ocean of Storms (Oceanus Procellarum). This could be a source of potassium and phosphorus, the two major fertilizer ingredients with nitrogen being the third, needed for agriculture. Potassium hydroxide could serve as a caustic for chemical processes. Phosphorus is indispensable for making solar panels. While p-type solar panel material might be made by doping silicon with aluminum instead of boron (which is rare on the Moon), n-type material must be doped with phosphorus.

We won't get very far on the Moon without electricity and we can't get solar panels without phosphorus so it seems reasonable that industrial bases should be located near KREEP terrain. However, it might be argued that solar thermal electric generation systems with aluminum or magnesium reflectors and titanium or steel boiler tubes and turbogenerators could be made anywhere on the Moon where Ca and Al rich highland regolith and Fe-Mg-Ti rich mare regolith are available such as a (mare/highland) coastal location. Solar thermal electric systems reach 25% efficiency while silicon PVs are 10-15% efficient. Solar thermal systems are more complex therefore they require more maintenance. Presently it is not known whether silicon PVs or solar thermal systems offer more practicality and economy when it comes to making them on the Moon. Lunar manufacturing is still in its infancy. Hard data will be required to make this decision.

KREEP also contains rare earth elements. These REEs might be used for alloying iron, steel, aluminum, magnesium and titanium since many of the elements commonly used for alloying on Earth are lacking on the Moon. REEs are also used in many electronics applications and as catalysts. Their industrial uses are too many to be listed here. For more information, see:

MMM Theme Issues: The Lunar Economy - Years 1-25 Dec 1986 - Nov 2011

<http://www.rareelementresources.com/s/Uses.asp>

Thorium and uranium are also found in KREEP. These elements might be used as nuclear fuels for space ships built of lunar materials in the future. Thorium itself is not fissile, but it can be converted to U233 in a breeder reactor primed with U235 and eventually plutonium. While thorium and uranium are only present at parts per million, proposals have been made for extracting uranium from granite on Earth that contains only 4 ppm U and seawater where uranium is present only in parts per billion. So the extraction of thorium and uranium from KREEP is not totally unrealistic.

2) Pyroclastic glass.

Volcanic glass, also called pyroclastic glass, is found in many places on the Moon. The largest deposit is in the Ocean of Storms just west of the Aristarchus Plateau (area 37,400 km².) Glass from volcanic fire fountains contains more chlorine, nickel, copper, zinc and gallium than is common in regolith and these elements can be obtained by roasting the glass particles [1]. The glass can also be reduced with hot hydrogen to gain oxygen.



The Aristarchus Plateau as seen from the NW

Deep, bright Aristarchus at left, Herodotus at right, Schroeter Valley winding below

Chlorine is needed to extract aluminum by electrolysis, make silane and silicones, form silicon tetra-chloride to obtain pure silicon for PVs, and table salt when combined with lunar sodium. Nickel is useful for iron and steel alloying and as a catalyst for shifting hydrogen and carbon monoxide to methane and water. Copper and zinc are used for alloying aluminum and magnesium respectively. Gallium can be combined with arsenic to make high efficiency solar panels.

3) Volcanic gas?

This one is highly speculative. The Marius Hills in the Ocean of Storms contain over 200 low volcanic domes. Could there be intact chambers of volcanic gas there? Could this gas contain carbon monoxide, sulfur compounds, even water? Subduction zone volcanoes on Earth, like the famed Mt. St. Helens, emit lots of water vapor from the ocean drawn under by geological processes. Hot spot volcanoes like Hawaii also emit water vapor from deep within the Earth though not as much as subduction zone volcanoes. The domes of Marius Hills will be more like hot spot volcanoes. Some of the same elements found on pyroclastic glass particles like chlorine and copper might be concentrated below these domes. If so, they could be mined in shaft mines.

MMM Theme Issues: The Lunar Economy - Years 1-25 Dec 1986 - Nov 2011

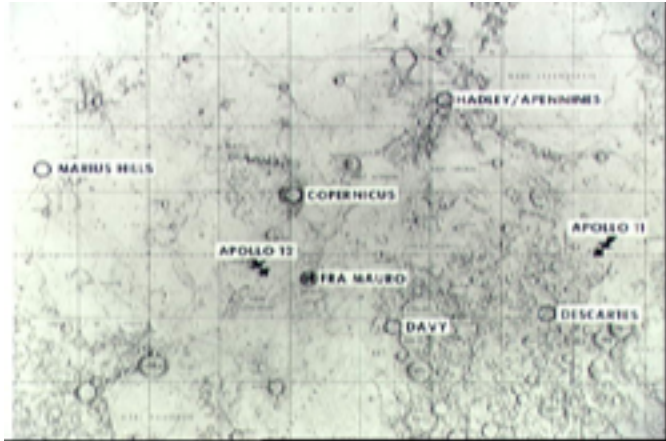

We will need lunar orbiters with powerful ground penetrating radars to investigate below the surface of the Moon. We will also need landers with geophones, sort of like underground sonar systems used to hunt for oil on Earth, and explosives or inert projectiles collided with the Moon to set up vibrations in the Moon that might reflect off of sub-selene formations including volcanic gas pockets. Then we will need robotic landers with drills to tap this gas, should it exist, and analyze its composition.

If we found large quantities of CO, S compounds, even H₂O beneath the Moon, this might be easier to tap by drilling than mining for ice in near absolute zero cold trap craters in polar areas. Carbon monoxide gas could be combined with lunar oxygen obtained by molten silicate electrolysis perhaps to make CO₂ for CELSS. It could also be used for carbon for steel making, other metal extraction processes, even metal matrix composites like graphite/magnesium or silicon carbide/aluminum. Hydrogen from water could be combined with carbon to make some plastics. Sulfur could be used for sulfur concrete and sulfuric acid for metal extraction.

There is also the possibility that the Moon is "burping" radon from its interior. While radon is not very useful, its presence, should it exist, indicates the decay of uranium. Could the domes of Marius Hills exist because of large quantities of uranium below the surface decayed and released heat? Could there be more uranium and perhaps thorium too down below in richer deposits than KREEP which only contains about 4ppm U and 10 ppm Th?

Since uranium decays to lead, could there be lead down there? Lead might not be useful as an industrial metal but it can be used to stain glass and get real red colored glass thus it would be valued by lunar artisans. Further, lead could also be used as a dopant superior to Sodium and/or Potassium to lower the melting point of mare regolith for use as a matrix in glass-glass composites. Perhaps shaft mines could be dug with cabled teleoperated robots to get at these speculative deposits of uranium, thorium and lead. While these sub-selene resources of volcanic gas, other elements and radioactives are mere conjecture at this time, the possibility of their existence is so tantalizing that we must investigate.

MMM Theme Issues: The Lunar Economy - Years 1-25 Dec 1986 - Nov 2011



Location of a mining base or mining bases within the range of ground vehicles for access to the KREEP terrain, pyroclastic glass deposits and volcanic domes of Oceanus Procellarum will require more study. I don't have the required tools to measure distances on the Moon, but by simply eyeballing a map it looks like Aristarchus and Marius are much closer to the KREEP terrain of Mare Imbrium on the coast of the Jura Mountains than from the NW ramparts of Sinus Iridium (Bay of Rainbows) than to the KREEP terrain of Procellarum to the east near the Sea of Clouds (Mare Nubium). T

he base or bases should be located near a coast so that Fe-Mg-Ti rich mare regolith as well as Al-Ca rich highland regolith can be mined.



Off road vehicle convoys and railroads will be needed; perhaps pipelines too. The base, or bases, would initially consist of an "industrial seed" of robotic mining, regolith refining and manufacturing devices that could self-replicate using only lunar resources and small cargoes from Earth. Small human crews would supervise the robots. As the seed grows into full-fledged smelters, factories and larger habitats, more humans will go to the Moon. Industrial production will have to reach a scale at which millions of tons of materials were produced every year for a solar power satellite-building project.

Thousands of large helium 3 mining tractors would be built also. Scientific research, tourism, Moon made ships for asteroid mining and asteroid deflection forces to repel asteroids on collision course with Earth or our bases on the Moon, support for Mars colonization efforts in the form of metal for spaceships and propellant as well as equipment to be used on Mars mined and made on the Moon, and probably unforeseen uses of lunar materials, will all emerge.

1] Cooper, B.L. (1994) Reservoir estimates for the Sulpicius Gallus region. Space 94: Engineering, Construction and Operations in Space, pp. 889-896. American Society of Civil Engineers, New York.

D. Dietzler



Defining the Lunar Industrial Seed: What Comes Before and How?

By David Dietzler pioneer137@yahoo.com © 2009

Part 1) What We Need

Seed Products and Mass Production

Given the high cost of space transportation it is necessary to minimize upported* mass to save money and make a solar power satellite project economically feasible. The mass of the lunar industrial seed must be kept as low as is possible while still making it possible for the seed to mine, produce materials, self replicate and manufacture everything from bricks to mass drivers on the Moon. Before we can determine the components of the seed we must ask, "What are we going to make?" Before we answer the question, "How are we going to make it?" we must design before we manufacture and we must design for manufacturing. In other words, we must design things that can be made simply and economically with limited lunar materials.

[* One frequently hears that there is no "up" or "down" in space. That is a half truth, as space is sculpted by gravity which affects the motion of everything. Earth, being 80 times as massive as the Moon, has a much deeper "gravity well," and it is proper to speak of 'upporting' items from Earth to the Moon, and 'down-porting' things from the Moon, to GEO, LEO, or to Earth itself. The difference in fuel costs is consider-able and greatly effects the economics involved. - Ed.]

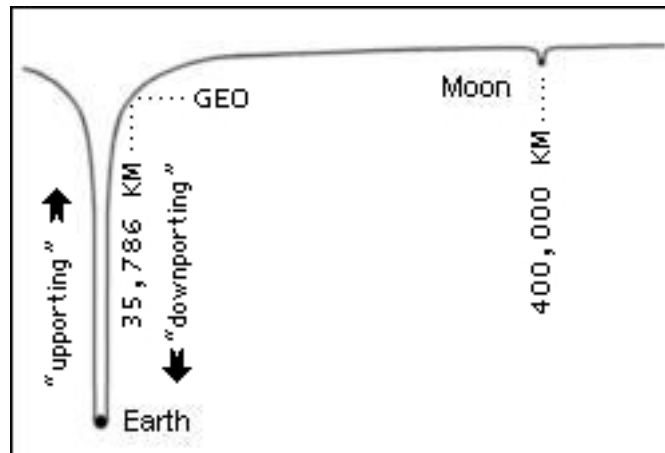

At first we will upport complete inflatable habitat modules with electrical and communications systems, life support systems and interior furnishings. We will also upport vehicles, mining machines and robots. Once we get a small base established we will start making things by the use of human/robot synergy.

If we are to grow a lunar industrial seed massing from several hundred to several thousand tons into lunar industrial complexes amassing millions of tons we will have to engage in mass production. Standardization is one of the keys to mass production. We need to figure out, or somebody else does, how to make in no special order standardized lunar products such as:

LOW TECH ITEMS

- A brick (interlocking?)—cast basalt, glass and ceramic from magma electrolysis
- A block—same materials as above and possibly from concrete also

MMM Theme Issues: The Lunar Economy - Years 1-25 Dec 1986 - Nov 2011

- Aa slab–ditto
- Various tiles–ditto
- A sewer pipe–ditto–this could also be used for air ducts
- A water pipe–ditto, and metal pipes too
- Elbows and Ts for both pipes–ditto*
- Water faucets, plumbing parts like shower heads, etc.*
- A steel or pure iron rail
- A tie, unless we go with monorails _various steel, pure iron and titanium bolts, rolled threads*
- Various nuts*
- Various iron plates
- An iron beam
- An iron stud
- A cement board and maybe a drywall section**
- Various gauges of aluminum wire with glass cloth insulation
- Various electrical parts–a switch, connectors, junction box, etc.*
- A door frame that can have either glass or metal plate in it
- A door knob*
- A hinge*
- A non–insulated water and sewage tank
- Metal pipes for conveying high pressure gases
- A toilet***
- A bath tub or shower stall
- A planting box–made of bricks or blocks i guess
- A sink
- Various pieces of furniture made of CB, metal or AAC
- A glass fiber cloth sand bag for piling up regolith sand bags around modules for rad and therm protection. this bag could also be used for cement and groceries, etc
- A bottle* that can also be filled with various beverages
- A half gallon milk bottle*
- A canning jar that can double as a foodstuffs jar*

* [**bottle, jar**] These items will be small, lightweight, and not needed in very large numbers during the early base construction stage lasting perhaps six months to a few years, so they will be upported until lunar manufacturing capacity grows and these parts are needed in large numbers and high total masses. While some might say, "What? a water faucet when it costs thousands of dollars per pound to the Moon?" I can only say that the machines and manpower needed to make these in the early stages when there is low demand for these might far outweigh the items themselves; and since time is money we need to get a base built and expand it rapidly. Upported bottles could be made of lightweight plastics and even plumbing parts too. When we get metals and glass on the Moon, old thermoplastic parts could be ground up, melted down and turned into more valuable products.

** **Cement board** is preferred to drywall. Cement can be made simply by roasting and steaming highland regolith; while making drywall will require sulfuric acid leaching. Drywall is more fragile than cement board; and it can be made by laying plaster between two sheets of glass fiber cloth, so facing paper is not needed. It's easier to saw, but that produces lots of dust. We might be leaching regolith is sulfuric acid during aluminum extraction and this will lead to lots of calcium sulfate, which is plaster, and silica for glass. There are aluminum extraction processes that don't require acid leaching but it's too soon to tell what process will be used. If we do acid leaching that plaster byproduct should be put to use. If not drywall, then for aluminum and magnesium casting molds and medical casts.

*** Flush mechanisms would be upported for toilets. If anything has to work right, this does (lol).

MMM Theme Issues: The Lunar Economy - Years 1-25 Dec 1986 - Nov 2011

MORE COMPLEX ITEMS

- A silicon solar panel
- An airlock and hatches etc._various electric motors–these might be among the more complex lunar manufacturing jobs we must do. Mark R. has pointed out that large motors will need cooling systems
- A high pressure gas storage tank
- An insulated cryo liquid storage tank_valves for hp gas pipes
- A heliostat
- A fiber optic bundle
- An electric stove
- A ventilation fan
- A cooling unit _compressors? _space radiators?
- A solar furnace, therefore a reflector system
- Vehicles–two–a van and a truck made by stretching the van and sticking 4 std wheels on the back end with std electromagnetic brakes and std motors in each wheel. Std batteries wired in parallel. see:

http://www.moonminer.com/Lunar_Model_T.html

Heavy equipment:

- One volatiles harvester model
- One mining shovel model
- One small crane model and
- One large crane model that can also become a drag line

Standard vehicle and heavy equipment parts, frames, etc. will be necessary. This will get complicated. We will have to keep designs as simple as possible and leave out frills.

Machine tools: drill presses, lathes, milling machines, CNC machines, perhaps something like the Multi-Machine will be central to machining products on the Moon. see:

<http://groups.yahoo.com/group/multimachine>

Mass drivers: these will be the crowning achievement of lunar industry, allowing the export of lunar materials into space for construction of powersats, telecomm platforms, colony ships to Mars, robotic asteroid mining ships, etc. Many of these items will be very complex and require an advanced manufacturing capacity on the Moon.

We will follow Peter Kokh's MUS/cle strategy http://www.moonsociety.org/publications/mmm_papers/muscle_paper.htm and make the Massive, Unitarian and Simple parts like refrigerator casings on the Moon and support the guts of the machine–coils, compressor and motor [1]. The complex, lightweight and electronic (or expensive) parts of compressors, cooling units, fans, valves, etc. will be supported and the MUS stuff like iron casings will be Moon made. Machine tools will be very complex and demand exacting tolerances. At first, during the early years of base development, we will support them. We will have to support 3D additive printing machines like Direct Metal Laser Sintering devices to make the finer parts and we will support the finer parts like the precision motors of lathes until we get the ability to make them on the Moon, while heavy metal bases and frames could be Moon made. We will also support lots of solar panels of the highest efficiency and lowest specific mass available because nothing will work without power and expansion without power will be impossible.

The list above is certainly incomplete. I welcome others to modify and add on to the list.

Works Cited Part 1

MUS/cle Strategy for Lunar Industrial Diversification

© 1988 The Lunar Reclamation Society

http://www.moonsociety.org/publications/mmm_papers/muscle_paper.htm

Note, this paper in its entirety is online at:

MMM Theme Issues: The Lunar Economy - Years 1-25 Dec 1986 - Nov 2011

<http://groups.google.com/group/international-lunar-resarch-park/web/lunar-industrial-seed?hl=en>

Dave Dietzler of the Moon Society St. Louis chapter, has been contributing quality technical articles in MMM since #158, August 2002. Besides his many articles, his input has improved many pieces written by the editor. Dave is also a member of the Moon Society Board of Advisors.

MMM # 230 November 2009



Defining the Lunar Industrial Seed: What Comes Before How?

By David Dietzler pioneer137@yahoo.com © 2009

Part 2) Lunar Materials

The Moon: "Pie in the Sky!" But, oh, what a recipe!

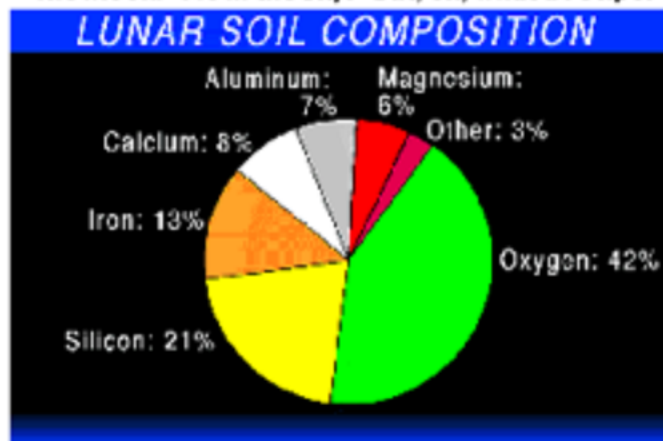

<http://nsschapters.org/hub/pfd/MoonPieChart.pdf>

Solar Wind Implanted Volatiles
Those Precious Light Elements

MMM Theme Issues: The Lunar Economy - Years 1-25 Dec 1986 - Nov 2011

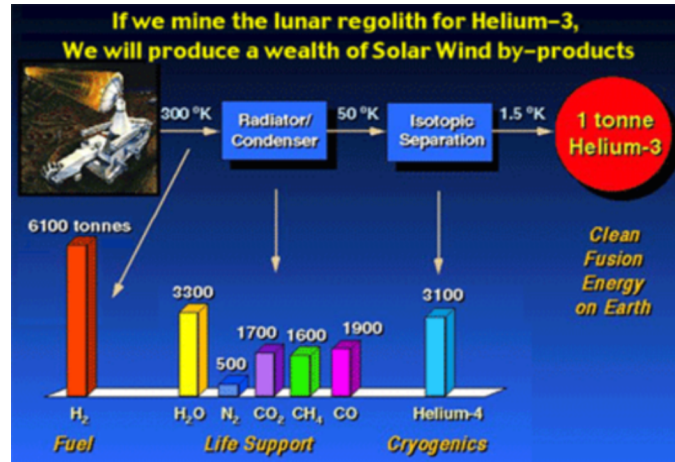

Perhaps the first job to be tackled on the Moon will be mining for solar wind implanted volatiles—hydrogen, carbon, nitrogen and helium. These will be needed for life support and industrial processes. Mining robots will shovel up regolith, load it into onboard furnaces, and roast out the volatiles at about 700 C.

Hydrogen will come off as is and some will react with oxygen in the silicates of the regolith to form H₂O. Carbon will form CO, CO₂ and CH₄. Nitrogen is almost inert and will come off as is and so will helium, both helium 3 and normal helium 4.

Hydrogen is needed for ilmenite reduction and CO and CO₂ will be reacted with H₂ over a nickel catalyst to form CH₄ that can be decomposed with heat at about 900 C. to yield carbon and recover hydrogen. Carbon will be needed for life support systems when agriculture begins, steel and for carbonyls of iron and nickel for chemical vapor deposition processes. Until agriculture begins and closed ecological life support systems are at work, CO₂ will be a nuisance removed from cabin air with physiochemical systems and dried food will be upported and rehydrated with recycled water.

Once CELSS is going, the top priority for carbon will be life support rather than industrial processes. Fortunately, industry won't demand much carbon since there are substitutes for steel and CVD won't require much either. Also, all carbon used for CVD will be strictly recycled. Nitrogen will have uses for CELSS. Helium can be used as an inert gas for work chambers where vacuum and oxidation are undesirable and as a rocket fuel tank pressurant.

Storage and processing systems for these gases and water must be upported. Hydrogen can be stored in solid media and room temperature. Carbon monoxide, dioxide, methane and nitrogen can be liquefied with pressure and cooling. Helium must be cooled to near absolute zero so this element must be stored in high pressure gas tanks since it might not be practical to upport heavy multistage cooling equipment; however, if the helium is piped through shielded space radiators exposed only to the ten degrees Kelvin temperature of outer space, it might be possible to liquefy helium on the Moon without excessively heavy machines.

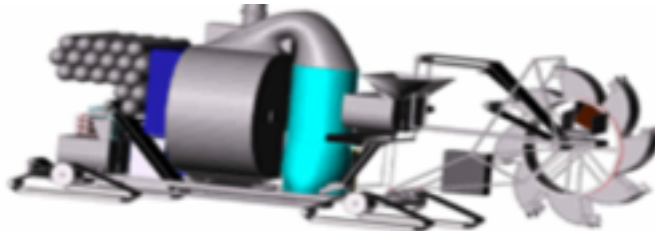

The Mark 3 miner designed at the University of Wisconsin, Madison, is projected to amass ten tons and could produce over 200 tons of hydrogen, 16.5 tons of nitrogen, 82 tons of carbon and about 100 tons of helium every year [1]. That's an incredible bounty from a ten ton machine, not counting the solar power systems needed to energize the machine, when it will cost thousands of dollars per pound of mass sent to the Moon. One of my associates has

MMM Theme Issues: The Lunar Economy - Years 1-25 Dec 1986 - Nov 2011

calculated that with the Apollo system it cost \$30,000 to send a pound to the Moon. If the cost of upports drops to say \$10,000 a pound with the success of rockets like the Space X Falcon 9 then we would still pay \$4 billion to send 200 tons of H₂ to the Moon. A pound of 1% carbon high grade steel for drill bits or milling heads would contain \$100 worth of carbon. That's a high price for steel. Better to use lunar carbon for lunar steel. The value of mining for solar wind implanted volatiles on the Moon is clear.

One of the first jobs we should do on the Moon is mine for volatiles and stock up a supply of them pending later development on the Moon. This could be done with teleoperated robots years before a manned base is constructed.

That Essential Oxygen

Oxygen is necessary for breathing and producing water, but also for rockets. A reusable robotic Moon Shuttle might tank up with LOX on the lunar surface and rendezvous with spacecraft arriving in LLO with just enough fuel for landing on the Moon. The Moon Shuttle carrying enough LOX for descent will dock with the cargo craft and take on fuel then descend to the lunar surface. This system will increase the amount of cargo that would otherwise consist of oxidizer upported from Earth to the Moon and reduce costs. If the system is reliable enough it could be used to land humans on the Moon too and supply LOX for return to Earth.

Fuel for the Moon Shuttle's ascent would have to be produced on the Moon. If one Mark 3 miner can produce 200+ tons of hydrogen a year, a small fleet of them could produce enough H₂ for fueling Moon Shuttles as well as other purposes. It might be possible to stretch the hydrogen supply by combining it with lunar silicon to produce silane-SiH₄. Naturally, we'd have to upport the silane making equipment. Keep in mind that oxygen is 6/7 to 8/9 of the propellant mass in a hydrogen/oxygen fueled rocket, depending on mixture, and 2/3 the propellant mass of a silane/oxygen fueled rocket.

Not only must we produce oxygen, but also storage tanks, piping systems, pumps and space radiators to liquefy oxygen. We will need a system for producing oxygen, probably molten silicate electrolysis or vapor pyrolysis. These systems could also produce silicon for making silane. . Lander tanks might be used for the first LOX storage tanks.

In the early years we will upport insulated LOX storage tanks and associated piping, compressors and space radiators. To make foil shielded space radiators exposed only to the ten degrees K. temperature of outer space we will need metals production on the Moon, and this will require upporting some small smelting furnaces and making some large furnaces on the Moon from cement, silica and/or titanium dioxide bricks.

Cast and Sintered Basalt

This simple and general purpose material can be made just by putting some mare regolith which is just hardened lava pulverized by eons of meteoric bombardment into a fine powder into a furnace and heating it up to 1250-1500 C. The molten regolith will be poured out into sand molds dug in the soil to cast bricks, blocks and slabs. To make sintered blocks we must put the Moon dust into trays to size the blocks and heat them up just enough to get the edges of the particles to fuse. This simple black glassy material, cast basalt, has been used for centuries to make pipes, tiles, blocks and even fine table ware. It is very hard and abrasion resistant.

Mobile robots could use microwaves to melt mare regolith as they roll over it to make roads after the stuff hardens that vehicles and robots could roll over without kicking up dust. Landing and launching pads could also be made this way. Entire areas surrounding Moon bases where manufacturing and construction are going on might be treated this way so that dust isn't kicked up by wheeled vehicles and robots.

Silicon and Iron

These can be produced by serial molten silicate electrolysis also called magma electrolysis [2]. In the same way that an electrical current can be passed through water to break it down into oxygen and hydrogen, a current can be passed through molten regolith to partially break it down into its constituent elements. This also yields oxygen and a ceramic that melts at

MMM Theme Issues: The Lunar Economy - Years 1-25 Dec 1986 - Nov 2011

about 1500 C. The ceramic might be used to build more magma electrolysis furnaces. Sodium, potassium, phosphorus and sulfur might be produced as impurities in the oxygen that could be filtered out in cold traps. Silicon will probably need purification in vacuum distillation furnaces and by zone refining before doping to make solar panels.

Iron could also be extracted from regolith where meteoric iron fines are present at up to 0.5% by weight. Low intensity magnetic separators and grinders to bust up the silicates adhering to the fines will be used [3]. This meteoric iron contains 5% nickel and 0.2% cobalt.

Iron might be combined with some upported or Moon mined carbon, preferably Moon mined carbon, by using the old blister steel or cementation process to convert it to stronger steel. see: <http://www.moonminer.com/blister-steel.html>

Titanium and Titanium Dioxide

The mineral ilmenite can be concentrated by magnetic and electrostatic processing of mare regolith where it is about ten times more abundant than in highland regolith [4]. Ilmenite can be reduced to titanium dioxide and iron particles with hot hydrogen gas in a fluidized bed. Water forms and is condensed, electrolyzed to recover hydrogen and gain oxygen. The fused TiO₂ and iron particles can be separated by roasting in the vacuum or by treatment with CO gas to produce iron carbonyls. Titanium dioxide particles could be sintered to make a high temperature ceramic that melts at 1800 C. Since cast basalt (molten regolith) melts at 1250–1500 C., iron at 1200–1500 C., silicon at 1400 C. and silica at 1700 C., these materials could be melted in titanium dioxide lined furnaces. Titanium metal could be obtained by deoxidizing TiO₂ in FFC cells filled with upported CaCl₂ flux. The FFC process will also generate oxygen. Sponge titanium from FFC cells would be melted with electron beams instead of arc furnaces and cast into slabs, ingots and billets or atomized to get Ti powder without adverse reaction with hydrogen, nitrogen or oxygen in the free lunar vacuum.

Magnesium

It might be possible to concentrate magnesium bearing olivines and pyroxenes from mare regolith by magnetic and electrostatic means. These could be reduced to magnesium metal in furnaces with silicon from magma electrolysis and a calcium aluminate (CaAl₂O₄) flux at about 1500 C. The magnesium metal boils off and is condensed. If olivines and pyroxenes don't take to silicothermic reduction, then magnesium oxide obtained by roasting regolith at 1500 C. and hotter will be used. Silicothermic production of magnesium has now all but replaced magnesium chloride electrolysis.

Aluminum

Three processes stand out for aluminum production. All will involve concentration of anorthite by magnetic and electrostatic means.

- A) 1) Sulfuric acid leaching of anorthite.
2) Roasting aluminum sulfate to aluminum oxide
3) Carbochlorination of Al₂O₃ 4) Electrolysis of AlCl₃ in a flux of lithium and sodium chloride [5].
- B) 1) Direct carbochlorination of anorthite
2) Distillation of AlCl₃ and SiCl₄
3) Electrolysis as in step 4 above [6].
- C) 1) Roasting anorthite at up to 2000 C. to get CaAl₂O₄ 2) Electrolysis in a lithium fluoride flux [7]

Process A will yield a lot of CaSO₄ and silica by-product. If the CaSO₄ is not useful, it can be decomposed with heat to recover sulfur. Process C seems simplest but it will require a very high temp. furnace, upported lithium fluoride since these two elements are lacking on the Moon, and special alloy electrodes. Carbon and chlorine will have to be carefully recycled. The only likely lunar source of chlorine is pyroclastic glass.

Cement

This all purpose material can be produced by roasting highland regolith at 1800–2000 K. to drive out SiO₂ and enrich CaO content [8]. The SiO₂ can be condensed and used for glass. Glass fiber reinforced concrete will be very strong. Typical Portland cement contains 5% CaSO₄

MMM Theme Issues: The Lunar Economy - Years 1-25 Dec 1986 - Nov 2011

to slow setting time. I don't know if this will be necessary for lunar cement but if aluminum process A above is used there will be plenty of CaSO₄ available. Cured cement does not have to absorb CO₂ to set as does lime and sand mortar and it contains about 5% water by weight. Cement things could be cast in pressurized inflatables to recover H₂O as it dries. Sulfur can also be used to make cement. Habitat modules made of concrete will be buried, thus not exposed to thermal extremes and will not expand and contract so much that they crack. With thick enough walls and glass fiber reinforcement they will stand up to internal air pressure well.

Glass

Glass is yielded by H₂SO₄ leaching, roasting regolith to get cement and by roasting regolith to get MgO. Molten glass can be drawn through dies to get glass fibers. These glass fibers can be mixed with molten glass that has been mixed with lunar sodium, potassium and perhaps even lead, if any from uranium decay on the Moon, to lower its melting point and the result is a glass-glass composite material. This material needs more study. It might even have Earthly applications.

Sulfur

Regolith contains c. 500 to 1700 ppm sulfur. To the best of my knowledge most of this is in the form of the meteoric mineral Troilite-FeS. This mineral could be extracted electrostatically from large masses of regolith by machines similar to the ones that mine for volatiles and iron fines. It could be decomposed with intense heat in a solar furnace to get sulfur and some iron too. Molten sulfur can be used instead of water to make cement. We might be more willing to sacrifice sulfur than water if we must cast large concrete objects out in the vacuum.

References Cited Part 2

1] A Lunar Volatiles Miner by M. Gadga et al.

www.nasa-academy.org/soffen/travelgrant/gadja.pdf

2] Oxygen From the Lunar Soil by Molten Silicate Electrolysis

Russell O. Colson and Larry A. Haskin* 1990 <http://www.belmont.k12.ca.us/ralston/programs/itech/SpaceSettlement/spaceresvol3/oflsmse1.htm>

3,4] Pilor Production at the Moonbase 2015, H.H. Koelle

<http://www.highfrontier.org/Archive/Jt/Koelle%20PILOT%20PRODUCTION%20at%20the%20MOONBASE%202015.pdf>

5,6] Extraction Processes for Production of Aluminum, Titanium, Iron, Magnesium, and Oxygen for Nonterrestrial Sources. D. BHOGESWARA RAO, U.V. CHOUDRY, T.E. ERSTFELD, R.J. WILLIAMS AND Y.A. YANG

<http://www.nas.nasa.gov/About/Education/SpaceSettlement/spaceres/V-5.html>

7] Processing Lunar Soils for Oxygen and Other Materials

Christian W. Knudsen and Michael A. Gibson <http://www.belmont.k12.ca.us/ralston/programs/itech/SpaceSettlement/spaceresvol3/plsoom1.htm>

8] Cement and Concrete. Gene Corley and Larry A. Haskin

<http://www.belmont.k12.ca.us/ralston/programs/itech/SpaceSettlement/spaceresvol3/cemncon1.htm> <DD>

The Lunar Industrial Seed, Cont.

Part 3A: Manufacturing

The "MUS" part of the Industrial Development MUS/cle Strategy*

http://www.moonsociety.org/publications/mmm_papers/muscle_paper.htm

Massive, **U**nitary and **S**imple things that will be costly to support but easy to make on the Moon due to their simplicity will be manufactured during the early stages of lunar base

MMM Theme Issues: The Lunar Economy - Years 1-25 Dec 1986 - Nov 2011

development lasting from several months to a few years. **Complex, lightweight and electronic** (or expensive) items will be upported until the base grows to a point at which large numbers of small to medium sized parts are needed.

Furnaces

Some of the heaviest pieces of equipment used on the Moon will be furnaces for refining regolith and minerals, melting metals for casting, making cement and melting glass for fibers and other uses. A 70 tons magma electrolysis furnace would use 3 MWe and produce about 1000 tons of oxygen, several hundred tons of silicon and iron, and over a thousand tons of ceramic in a years' time [1]. If the mass of the industrial seed is several hundred tons this will really make a dent in our mass budget. We will need to upport a much smaller furnace and use it to get some ceramic for constructing more furnaces as well as provide some oxygen, silicon and iron. The ceramic could flow out of the furnace and into sand molds to make blocks that are welded together with electron beams or microwaves to build another larger furnace. The platinum electrodes would have to be upported. There would also have to be systems for piping away and storing the oxygen and solar panels to energize the furnace.

Other furnaces could simply heat regolith or metals to melt them down and cast them into ingots or plates and slabs. Some furnaces will use electrical heating elements, probably upported in the early years, and others will use concentrated solar energy. Since some materials reflect light electric furnaces will be preferred to heat these. Solar furnaces will also need large Sun tracking reflector systems to collect enough energy to super heat materials. The use of titanium dioxide brick or block linings that are also e-beam or microwave welded together must be considered. The linings would not have to be thick enough to give structural strength to the furnace, but only thick enough to insulate the surrounding concrete that makes it sturdy enough to contain tons of molten materials.

Liquid Gas Storage

We will need to store liquefied CO, CO₂, CH₄ and N₂ from volatiles mining. Hydrogen could be stored in solid hydrides or carbon nanotubes. Helium might require high pressure gas tanks. Since commercially pure titanium is strong enough for LOX storage systems, and is more corrosion resistant than stainless steel, it might be best to make the tanks out of titanium although titanium production is more complex than iron and steel production but less tricky than aluminum production. Some aluminum and tin to alloy the titanium might also be required.

Lander tanks might be used for the first LOX storage tanks. To make more tanks and accessories we will need to produce metals. The first metal to be produced on the Moon might be iron from magnetically extracted iron fines of meteoric origin that compose up to 0.5% of the regolith. This iron might be combined with some carbon, preferably Moon mined carbon, by using the old blister steel or cementation process to convert it to stronger steel. The steel would probably be alloyed with nickel. The tanks would be lowered into trenches where they rest on cast basalt supports. Cast basalt is a good thermal insulator. The trenches will be covered with foil solar shields. It should stay good and cold down in the trenches. Will heat radiation from the regolith at minus 4 F. be a problem? That's warmer than LOX at minus 183 C. The walls of the trench could be covered with shiny low heat emitting foil and the vacuum will insulate more.

Solar Panels Needed Early

Initially, power will come from solar panels landed on the Moon. These might be GaInP/GaAs/Ge stretched lens array panels that get 300 w/kg to 500 w/kg and 300-400 w/sq. m.[2]. One metric ton of these could generate 300 kilowatts! More solar panels will have to be produced to replicate and grow the seed. We don't have exotic elements like gallium and indium on the Moon. Solar panels will require silicon, aluminum, phosphorus and glass. Some boron for doping p-type silicon and some phosphorus for n-type material could be upported and combined with silicon produced on the Moon to make more solar panels to power more equipment as needed.

MMM Theme Issues: The Lunar Economy - Years 1-25 Dec 1986 - Nov 2011

Eventually we will have to produce aluminum on the Moon to make p-type silicon and produce phosphorus too, so we will need devices for producing Al and P on the Moon as well as devices for producing silicon. We will also need devices for rolling aluminum slabs or ingots into sheets for the solar panel backing, extruding them into wires and devices for producing aluminum mesh for the top electrode to make solar panels.

Certainly, the MUS/cle strategy is needed here because rolling mills will be very heavy. It might be possible to make aluminum sheets by depositing vaporized aluminum on glass plates in the vacuum. Glass will also be used to cover the panels. Robots to assemble the solar panels, deploy them and wire them up will also be necessary. All expansion of the lunar industrial seed will depend on electricity so it will be necessary to produce solar panels in large numbers within just a few years' time after the manned and robotic initial base is built.

Basic Bricks

Brick making will be essential. I envision solar or electric furnaces loaded with regolith and molten regolith pouring out into simple sand molds dug in the lunar surface to cast bricks, blocks and slabs. Hopefully, the molten material will cool off and solidify before too much evaporation into the vacuum occurs. Iron molds with silica linings might also be used to cast bricks as they will cool down faster in such molds than they would in sand molds. Bricks will be needed for interior walls, walkways, and retaining walls that hold up regolith over buried modules. Slabs will be needed for short roads that robots can roll over without kicking up dust near the equipment. Cast basalt or pressed and sintered basalt possibly with metallic reinforcements will be used to make bricks and slabs. Molten silicate electrolysis also produces a spinel and silicate rich ceramic in addition to iron, silicon and oxygen with impurities most probably sodium, potassium and phosphorus that could be condensed from the oxygen.* The ceramic will melt at around 1500 C. and might be very useful. See:

<http://www.moonminer.com/Moon-bricks.html> and <http://www.moonminer.com/Magma-process.html>

Metal Plates

Metal ingots and slabs from simple sand molds will have to be rolled into plates and sheets. A rolling mill is a very heavy piece of equipment. Since aluminum and pure iron are softer than titanium, a rolling mill for these metals might be made of lunar titanium. While the electric motors will be supported at first, the titanium rollers and frame could be cast on the Moon. Graphite molds or copper molds with cooling passages, inert gas coolant and space radiators would be needed to cast titanium in the vacuum.

To roll steel and titanium plates we will need hard steel or cementite (Fe₃C) rollers. This would demand some carbon; even so, a 5000 pound rolling mill made of 1.5% carbon steel would only contain 75 pounds of carbon, so the sacrifice will not be great. I don't think we will be rolling steel plates on the Moon. We might be rolling titanium plates for pressurized vehicle cabins. It might also be possible to pour titanium plates ½" to 1" thick in shallow molds made of TiO₂ that are covered with a slab of glass to prevent evaporation of metal into the vacuum. Metal plates will be welded up to make buckets for mining shovels as well as other things.

Contour Crafting

A promising method of manufacturing and construction with cement/concrete is called Contour Crafting. This is similar to 3D additive manufacturing but on a much larger scale. It might be possible to "print up" concrete buildings and other items. See: <http://www.contourcrafting.org>

Cement will be needed for floors in chambers where molten metals are handled and cement or concrete cylinders several feet thick could be used for habitat modules. It can also be used to make cement board for walls, plumbing and furnishings. The lunar industrial seed must include solar or electric furnaces for cement making, sealed cement mixers and hoses, inflatables for working with cement in which we can recapture water vapor from drying cement items, and fuel cells for combining oxygen and hydrogen to make water as well as electricity.

To make plaster molds and sand molds, inflatable Kevlar work chambers filled with an

MMM Theme Issues: The Lunar Economy - Years 1-25 Dec 1986 - Nov 2011

inert gas will be needed. As the wetted plaster or sand dries precious water vapor will be recovered by dehumidifiers. The inflatable chambers will have concrete floors in case molten metal is spilled. The cement powder will be mixed with water in airtight devices and the wet cement will be pumped thru hoses into the chambers where it dries and the water vapor is recovered. Casting robots must work in pressurized chambers to prevent evaporation of molten metals in the vacuum also during casting operations. see: http://www.moonminer.com/Casting_Chambers.html

Cement and concrete production will not involve any upported chemical reagents as will some metal production processes and the equipment needed to make it will be comparatively simple. If concrete is exposed to the intense thermal cycles of the Moon it might crack; however, pressurized habitat modules made of concrete will be buried and the sub-selene temperature just a few feet down is a constant minus four Fahrenheit. Concrete could be strengthened by mixing it with glass fibers made from the SiO₂ that boils off when highland soil is roasted to make cement.

Extrusions

Extruders will be part of the lunar industrial seed. Rods, bars, rails, wires and pipes can be made by extrusion. Rods can be used for axles, bars for vehicle frames, rails for railways, wires and pipes for obvious uses. Lunar extruders will not use hydraulics. Their rams will be powered by electric motors and large screws or augers. It should also be possible to extrude hot soft glass or basalt into fibers for use as sound deadener, thermal insulation, concrete strengthener, and glass cloth. Special looms and sewing machines will be needed to make glass cloth items. Glass cloth will not be used for clothing because it is abrasive (although it might be coated with plastic-see:

www.asi.org/adb/02/16/01/01/glass-fiber-textiles.html

But it could be used for tents that protect equipment from the heat of mid-day, spacesuit outerwear, curtains, drapes, rugs, mildew resistant wallboard, insulation for electrical wires and runners that lunar workers can walk across out-vac without kicking up lots of Moon dust. It might also be possible to use glass cloth sealed with silicones to make inflatables on the Moon.

*Phosphorus is needed for n-type solar panel material. Along with potassium it is one of the three major fertilizer ingredients with nitrogen being the third. Potassium and sodium can be reacted with water to make potassium hydroxide and sodium hydroxide-caustics for soap making by mixing them with vegetable and/or animal fats. Soap will be an essential for humans on the Moon. Sodium is needed to make table salt, another essential for humans, and sodium hydroxide reacted with silica can make sodium silicate, an inorganic adhesive with many uses.

Works Cited Part 3A

1] **Development of the Moon.** Michael B. Duke et al. section 4.3.5.1 pg. 40

http://www.lpi.usra.edu/lunar_resources/developmentofmoon.pdf

2] <http://www.stretchedlensarray.com/Papers/SLASR-WCPEC4.pdf>

Note, this paper in its entirety is online at:

<http://groups.google.com/group/international-lunar-resarch-park/web/lunar-industrial-seed?hl=en>

About the Author



Dave Dietzler is a founding member of the St Louis Moon Society chapter and a major contributor to Moon Miners' Manifesto over the years, as well as the principal "co-brainstormer" with the editor on many technical issues that pertain to the establishment of a viable lunar frontier.

MMM # 231 December 2009



Defining the Lunar Industrial Seed:

By Dave Dietzler pioneer137@yahoo.com

Part 3B: Manufacturing

The "cle" part of the Industrial Development MUS/cle Strategy*

http://www.moonsociety.org/publications/mmm_papers/muscle_paper.htm

Complex, lightweight and electronic (or expensive) small to medium sized items will be supported in the early stages and mass produced when the base grows and the masses of parts demanded exceeds the mass of the machines and manpower needed to produce them. Manpower involves not just the mass of the worker, but also the mass of the habitat and life support needed to support the worker. These items will include computers and telephones for a long time because it costs billions of dollars to build a chip factory, but there might be a miracle like nano-fabrication with low mass nano-assemblers that changes this picture. Parts that will be Moon made after the MUS manufacturing stage is in full swing include hinges, nuts and bolts, pumps, switches robot parts and much more.

3D Additive Manufacturing

This method of automated manufacturing includes stereolithography, selective laser sintering and direct metal laser sintering. These machines build up material layer by layer. Guided by CAD data in computers they can make almost any small to medium sized part and not just simple ones but very complex detailed parts too. Accuracy is within thousandths of a millimeter, so precision parts can be made. Parts can be made of plastic, metal, glass or ceramic.

Stereolithography makes plastic parts up to 20" by 20" by 24." These parts could then be pressed into plaster to make molds for aluminum and magnesium casting; or they could be used to make impressions in sand molds for casting metals with higher melting points like iron or titanium. The biggest drawback to stereolithography is the cost of the photo-curable resin that costs \$300 to \$800 per gallon [1]. On the Moon, some way of recycling the resin would be

MMM Theme Issues: The Lunar Economy - Years 1-25 Dec 1986 - Nov 2011

needed so that we could make plastic parts for molds, convert the plastic back to photo-curable resin and make more molds.

Direct metal laser sintering can make parts from powdered metals. Parts can be made within dimensions of 250 x 250 x 215mm (9.84" x 9.84" x 8.46") [2]. The machine can run on its own 24 hours a day and make many parts faster than by conventional casting and machining. It is also possible to sinter metals with a device that uses an electron beam instead of a laser. This must be done in a vacuum and the Moon offers free vacuum. Since radiation can be emitted by e-beam sintering, piles of regolith for shielding will surround such machines during operation.

What kinds of parts will we make with Direct Laser (or E-Beam) Metal Sintering? I see casings and rotors for centrifugal pumps and pistons, rods, cylinders and crankshafts for reciprocating pumps. We will need pumps to move liquid gases, water and sewage. Electric motor armatures, bearing races and roller bearings, refrigerator compressor parts and high pressure gas compressor parts, perhaps parts for power tools also could be made. In the early years these could be supported. In time we will need very large numbers of these things. Everyone will want a small refrigerator in their cabin and some people with multi-room apartments will want full sized refrigerators. We will need lots of power tools and the plumbing systems will use lots of pumps. Compressors will be needed to drive oxygen gas through space radiators and pumps will be needed to move LOX into and out of storage tanks. Compressors will also be needed to drive hydrogen into hydrides or carbon nanotubes and to fill oxygen gas tanks in spacesuit life support backpacks.

While 3D sintering looks like the key to almost magical "Santa Claus machines" it might also prove that casting steel, aluminum, titanium, iron and magnesium parts is cheaper and quicker than using 3D sintering exclusively. Laser machining devices guided by computers would make the final cuts on the cast parts and drill holes in them. Robot arms and human workers would then assemble the parts.

Chemical Vapor Deposition

All sorts of items can be made by depositing carbonyl iron vapors on mandrels, heated to a few hundred degrees Celsius. The carbonyls would be formed by reacting iron fines with hot high pressure carbon monoxide gas made from Moon mined carbon and lunar oxygen. The work would be done in inert gas filled inflatable chambers so that when the carbonyls decompose and leave a steel coating on the hot mandrels the CO or CO₂ that is released, can be captured by air scrubbers to recycle the precious carbon. Galactic Mining Industries Inc. has done lots of work on this technology. See: <http://www.space-mining.com>

The process of depositing carbonyl vapors on mandrels to make things is called chemical vapor deposition or CVD. Usually, this process is good for making objects that are only about 1/16 to 1/8 of an inch thick. A tank this thick could hold water, but not high pressure gases. High-pressure tanks, valves and piping will have to be made with more conventional processes.

Iron fines that are 5% nickel and 0.2% cobalt when subjected to hot high pressure CO gas form carbonyls that can be vaporized and distilled to separate them at moderate temperatures. Nickel can be used as a catalyst and to strengthen iron and steel. Cobalt can be used for tough cobalt steel drill bits and we might be doing some extreme drilling jobs on the Moon. It can also be used to stain glass. Just ten pounds of cobalt can stain a ton of glass deep blue. This would add color to the drab Moon where psychological survival is as important as physical survival.

Spinning Metals

Steel, iron, aluminum, almost any ductile metal, can be spun. A metal disk is placed on a rotating lathe and formed against a mandrel into a lamp vase, bell, pot, pan, wok, musical drum, even CO₂ cartridges and high pressure gas tanks. HP gas tanks will be needed for spacesuits, life support systems, and welding gas tanks. CO₂ cartridges might be used for dart guns used by security guards to subdue troublesome characters.. A metal spinning lathe and

MMM Theme Issues: The Lunar Economy - Years 1-25 Dec 1986 - Nov 2011

supported or Moon made mandrels will be useful on the Moon. See:

http://en.wikipedia.org/wiki/Metal_spinning and <http://www.terrytynan.com/metalspinning.html>

Blacksmithing

This ancient art might find use on the Moon. Lunan blacksmiths with electric forges and power hammers could make all sorts of things including tools, hinges, pins, bolts and ornate metal work from iron and steel. We won't be able to do much without steel tools and ornate iron work will help with psychological survival. Iron could also be used for nuts and bolts and just about everything else today made of mild steel on Earth. Lunar iron will be rather pure like wrought iron and have similar properties (about 40,000 psi tensile) as opposed to cast iron that has more carbon in it than steel. Cast iron has about 3.5% carbon and steel is about 0.2% to 1.5% carbon. Iron from molten silicate electrolysis should be rather pure while iron from meteoric fines will contain some nickel and cobalt that makes it stronger.

Nuts and Bolts

Eventually we will need tons and tons of nuts and bolts for all the machines and vehicles that we assemble on the Moon. Bolts can be made by rolling extruded rods between steel dies. They can be made of aluminum, iron, titanium and rarely steel. While titanium bolts will be almost as strong as steel bolts, iron bolts will not be that strong but they can be made thicker and heavier. This shouldn't be a problem in lower lunar gravity.

Electrical Parts

These will be supported in the early years, but the time will come when we need large numbers of them therefore large masses that will be costly to support. Electric furnaces will require cables, switches, possibly microwave generators, electrodes and other parts. Cables and wires can be made by extrusion. Switches and other electrical parts might use cast basalt or glass insulating parts produced by casting or 3D sintering. Aluminum will be desirable for conducting components of electrical parts like switches as well as wiring. Titanium might be used for conducting components in some electrical parts too. Although it is not nearly as good a conductor as aluminum it has a much higher melting point and short thick sections of Ti in switches for instance won't offer a lot of resistance.

Glass Working

Silica is glass in its simplest formulation. Sodium and potassium can be added to lower its melting point and make it easier to work with. It could be used to make glass fiber reinforced glass composites, also known as glass-glass composites or GLAX. This material has a low coefficient of thermal expansion and has high tensile strength. Fibers could be made by extrusion. These fibers could also be used for fiber optic telecommunication cables on the Moon. Translucent GLAX could be used to make hangars for mining and other machines during the intense heat of day. Glass will also have mundane uses like windows, tableware, bottles, and laboratory ware. Glass fibers could even be woven into fabrics. We also need jars and bottles. A bottle blowing machine will be called for eventually.

Glass has other more exotic uses. Tubes filled with CO₂ and rods doped with neodymium from KREEP could be used for lasers. Quartz is basically pure silica and it can be used for high temperature windows in solar furnaces. Glass extraction and mining equipment as well as glass working equipment should be part of the lunar industrial seed.

Sand Mold Casting

Plastic forms could be used to make sand molds for casting iron, if we can make a decent sand mold with regolith. Regolith is like a very fine sand, but it is not like clay used to make sand molds. We must experiment with sieved and sized wetted regolith to see if it can be used to make sand molds. We must also look at the use of sodium silicate, an inorganic adhesive that can be made on the Moon from SiO₂ and Na₂O that is also used as a sand mold binder. Also, we must consider sintered regolith molds.

MMM Theme Issues: The Lunar Economy - Years 1-25 Dec 1986 - Nov 2011

Robots and Electric Motors

Beyond materials and various items discussed above, we will need to make more mining and manufacturing robots. This will be very complex. Small titanium parts for robots could be made by 3D sintering. Massive, unitary, and simple parts could be made by casting and laser machining. Complex, lightweight and electronic parts for robots could be upported from Earth.

Robots must be capable of welding as well as assembly. Most welding will be done by simple electric arc welding with steel rod electrodes that won't need shielding in the vacuum. High voltage DC power sources will be needed, so DC from solar panels might be inverted to AC, stepped up in transformers and rectified back to DC with upported solid state devices.

Electric motors will be needed in large numbers and in a variety of sizes to drive pumps and compressors, and to provide motion for robots and vehicles. Titanium, iron and steel parts and aluminum wires will be the primary components of electric motors. This will not be simple and the equipment sent to the Moon to make electric motors will be essential for industrial seed growth. Motor winding machines will be part of this. Power hammers to knock out motor housings from plates of iron or steel will probably be needed too. Small motor parts might be made of 3D sintered titanium. Some silicone or vacuum grease might be upported to lubricate the motors' bearings.

Works Cited Part 3B

1] <http://en.wikipedia.org/wiki/Stereolithography> 2]<http://www.morristech.com/dmls.asw>

Part 4: Conclusion At this point, we can list these things to be

Produced on the Moon: Heavy furnaces of bricks and slabs, rolling mills, LOX, iron, steel, storage tanks, piping, pumps, radiators, solar panels and their components of silicon, aluminum, phosphorus and glass, wires, cables, electrical parts like switches, bricks, slabs, roads of bricks and slabs, sulfuric acid, leaching vats, plaster, titanium, molds, cement, water, electric motors, robot parts and robots, vehicles.

The equipment needed to do this includes

(some made at least partially on the Moon, some upported):

Molten silicate electrolysis devices, solar panels, wiring/cabling, electrical parts (switches, transformers, solid state inverters and rectifiers), an aluminum rolling mill, extruders (for metal bars, rods, cables and wires and glass fibers); glass working equipment, electric arc welding devices, carbonyl vapor deposition systems, inflatable work chambers, furnaces for making cement, sulfuric acid making systems, electrostatic separators, metal extraction equipment for silicon, Al, Fe, Ti, Mg, furnaces for carburizing iron to steel, brick and slab making systems, electric motor making systems, grinders, 3D sintering systems, laser machining and drilling devices, and robots for mining, assembly and welding.** Also some carbon and hydrogen for metals and water; chloride salts for metal extraction and argon to fill the casting chambers.

That's a start. I have no idea what the mass of this will be. That will depend on how small engineers think the seed can be and how fast and how large it can grow. There are sure to be many things I have not thought of or chosen not to discuss in this article for the sake of brevity.

As the number of mining and manufacturing robots grows, along with oxygen, metal and solar panel production, larger and larger machines will be built to make larger and larger parts for things like human habitat modules, pressurized vehicle cabins, and mass drivers. Also, larger and larger mining robots will be built to mine vast amounts of regolith to supply the solar power satellite builders. The process will probably be slow at first and mistakes will be made and corrected. Fortunately the Moon is only three days away, unlike distant Mars, and it won't take a long time to correct mistakes by rocketing up some extra equipment. There will probably be humans supervising the robots and doing fine tasks by hand that are beyond the abilities of the robots. Humans on the Moon could fix mistakes shortly after they occur. Progress will then accelerate after the learning phase as the lunar industrial seed grows

MMM Theme Issues: The Lunar Economy - Years 1-25 Dec 1986 - Nov 2011

exponentially.

Timeline

I believe that within months of setting up the initial manned and robotic base, production of cement, oxygen and some metals could begin. Aluminum might be produced early not just for solar panels but also for rocket fuel. Powdered aluminum mixed with LOX can make a monopropellant about as powerful as a solid rocket. Magnesium does not require supported chemicals to produce as does aluminum, but it is shock sensitive and will detonate if it's tried for a monopropellant. See: www.space-rockets.com Perhaps a mixture of Mg and LOX can be used as an explosive. Within a few years it should be possible to produce all the major metals in regolith and some minor ones: chromium, manganese.

Within just a few years time it should be possible to make all the low-tech items listed above and many of the more complex items. In ten to fifteen years of rapid growth, the base will have grown into a true lunar settlement with numerous outposts and railways in action. Mass drivers should be working at this time and materials for solar power satellites, space stations, ships to Mars, asteroid deflectors, robotic asteroid mining ships, and whatever else will be available in space at a tiny fraction of the cost that would be paid to launch them up from Earth.

* Mining robots will consist of robots with onboard furnaces for roasting out solar wind implanted volatiles—hydrogen, carbon, nitrogen and helium. There will also be robots with magnetic separators for extracting iron fines of meteoric origin that compose 0.15% to 0.5% of the regolith. Other robots will simply excavate regolith that has been gone over for volatiles and iron fines and load it in devices that extract oxygen, silicon and metals.

D. Dietzler

A BASALT FIBERS INDUSTRY

New Basalt Fiber Industry Launched in India

MMM Special Report by Dave Dietzler

<http://www.fibre2fashion.com/industry-article/3/256/new-reinforced-material1.asp>

Now there is a new reinforcing material for textile composites: basalt fiber

From the website above:

By: Hireni Mankodi – Sr.Lecturer, Principle Investigator of Career Award for Young Teacher (AICTE Research Grant): Textile Engineering Department, Faculty of Technology and Engineering, M .S. University, Kalabhavan, Baroda: 390001, Gujarat, INDIA. email: hir_mak@yahoo.com

Introduction

Basalt fiber or is a material made from extremely fine fibers of basalt, which is composed of the minerals plagioclase, pyroxene, and olivine. It is similar to carbon fibre and fiberglass, having better physicomechanical properties than fiberglass, but being significantly cheaper than carbon fiber, It is used as a fireproof textile in the aerospace and automotive industries and as a composite to produce products such as tripods.

Basalt fibers are used in a wide range of application areas such as the chemical, construction and marine sectors, not to mention the offshore, wind power, transport and aerospace industries. This is due to their superior properties: not only do they boast good mechanical and chemical resistance, but also excellent thermal, electric and acoustic insulation properties.

Characteristics of Basalt Fiber

The raw material for basalt fibers is a naturally occurring mineral that belongs to the family of volcanic rocks. As a mineral, basalt ranges from dark gray to black. Basalt fibers are mineral fibers, which are 100% inorganic. Fiber compatibility with matrix resins can be ensured

MMM Theme Issues: The Lunar Economy - Years 1-25 Dec 1986 - Nov 2011

by using organic sizing agents. Basalt is well known in rock form and is found in almost every country around the world. It is traditionally used as crushed rock in construction and road building.

The fiber is 100% mineral continuous filaments. The focus is on the range of 9–13 microns for filament diameters. These diameters give the best compromise between tenacity, suppleness and cost. They are also safely larger than the 5 micron limit for non-respirability. As the fiber presents no hazard to health and environment, it is very suitable for asbestos replacement. The natural golden-brown appearance of the fabrics, can be covered for decorative purposes.

Main features of basalt fiber reinforcements

- High strength • High modulus • Easy to handle
- Corrosion resistance • High temperature resistance
- Extended operating temperature range



Basalt fiber and Preforms for Composite

MMM # 234 April 2010

LUNAR BASALT

What, Where, and its Critical Role for Lunar Industrialization and Settlement

By David Dietzler

With contributions from Peter Kokh

1) Technical Terms and Chemical Description of “Basalt,” “Gabbo,” “Lava,” “Magma”

Basalt is hardened surface “lava. Hardened subsurface lava is called gabbro. Molten surface rock is called lava and molten subsurface rock is called magma.

The lunar mare areas are covered with basalt pulverized into a fine powder by eons of meteoric bombardment. This material will be relatively easy to mine with power shovels.

This regolith consists of pyroxenes (iron, magnesium, and calcium silicates: SiO_3), olivines (iron and magnesium silicates Si_2O_4), ilmenite FeTiO_3 , spinels and plagioclase $\text{CaAl}_2\text{Si}_2\text{O}_8$.

Lunar basalts are classified as high, low and very-low titanium basalts depending on ilmenite and Ti bearing spinel content. **They differ from their terrestrial counterparts** principally in their high iron contents, which range from about 17 to 22 wt% FeO. They also exhibit a range of titanium concentrations from less than 1 wt% TiO_2 to 13 wt% TiO_2 . A continuum of Ti concentrations exists with the highest Ti concentrations being least abundant. Lunar basalts differ from terrestrial basalts in that they show lots of shock metamorphism, are not as oxidized and lack hydration completely.

See: <http://en.wikipedia.org/wiki/Basalt>

MMM Theme Issues: The Lunar Economy - Years 1-25 Dec 1986 - Nov 2011

Olivine contents range from 0% to 20%. Basalts from the mare edges or coasts probably contain more plagioclase, the mineral that makes up most of highland soils, than basalts closer to the center of the mare.

Types of Processed Basalt

- **Cast Basalt:** Basalt can be melted in solar furnaces, cast into many forms, and heated again and allowed to cool slowly (annealing) to recrystallize and strengthen the cast items. It can be cast in iron molds and possibly in simple sand molds dug into the surface of the Moon.
Iron could be obtained by harvesting meteoric Fe–Ni fines that compose up to 0.5% of the regolith with rovers equipped with magnetic extractors. Iron molds could be cast in high alumina cement molds. The high alumina cement could be obtained by roasting highland regolith in furnaces at 1800–2000 K to drive off silica and enrich CaO content. This could be hydrated in inflatable chambers with condensers to recover water vapor. It might also be cost effective to upport iron molds to the Moon since they would have a very long lifetime.
- **Sintered basalt** is not fully melted. It is placed in molds, pressed, and heated with microwaves or solar heat just long enough for the edges of the particles to fuse. This will require less energy than casting. Sintered Basalt can be used for low-performance external building blocks, pavers, and other uses.
- **Drawn basalt fibers** are made by melting basalt and extruding it through platinum bushings.
- **Hewn basalt** is quarried from bedrock, road cuts, or lava tube walls. It can be cut with diamond wire saws.

2) Uses of Basalt: source:

http://en.wikisource.org/wiki/Advanced_Automation_for_Space_Missions/Chapter_4.2.2

Table 4.16 Lunar Factory Applications of Processed Basalt

Cast Basalt – Industrial uses

- Machine base supports (lathes, milling machines)
- Furnace lining for resources extraction operations
- Large tool beds
- Crusher jaws
- Sidings
- Expendable ablative hull material (possibly composited with spun basalt)
- Track rails reinforced with iron prestressed in tension
- Railroad ties using prestressed internal rods made from iron
- Pylons reinforced with iron mesh and bars
- Heavy duty containers (planters) for "agricultural" use
- Radar dish or mirror frames
- Thermal rods or heat pipes housings
- Supports and backing for solar collectors
- Cold forming of Metal fabrication with heat shrink outer shell rolling surfaces

[Current industrial uses omitted above]

- Abrasion-resistant Pipes and conduits
- Abrasion-resistant Conveyor material (pneumatic, hydraulic, sliding)
- Abrasion-resistant Linings for ball, tube or pug mills, flue ducts, ventilators, cyclers, drains, mixers, tanks, electrolyzers, and mineral dressing equipment
- Abrasion-resistant floor tiles and bricks

Cast Basalt – commercial, agricultural, & residential uses (omitted on source list above)

- Large diameter (3" plus) pipe for water mains and for toilet and sewer drainage systems
- Floor tiles
- Countertops, tabletops, backsplashes
- Planters and tubs of all sizes, flower pots

MMM Theme Issues: The Lunar Economy - Years 1-25 Dec 1986 - Nov 2011

- Possibly contoured seating surfaces (contoured seats lessen the need for resilient padding, cushions)
- Lamp bases
- Many other commercial and domestic uses

Sintered Basalt (from URL reference above)

- Nozzles
- Tubing
- Wire-drawing dies
- Ball bearings
- Wheels
- Low torque fasteners
- Studs
- Furniture and utensils
- Low load axles
- Scientific equipment, frames and yokes
- Light tools
- Light duty containers and flasks for laboratory use
- Pump housings
- Filters/partial plugs

{Logical lunar uses omitted from above list}

- Blocks for shielding retainer walls
- Slabs for airlock approaches, external paths and walks
- lightweight light-duty crates and boxes
- Acoustic insulation
- Thermal insulation
- Insulator for prevention of cold welding of metals
- Filler in sintered "soil" cement
- Packing material
- Electrical insulation
- "Case goods" furniture as we might use wood composites such as OSB, MDF, etc.

Basalt Fiber – Uses (in place of glass fibers)

- Cloth and bedding, pads and matts
- Resilient shock absorbing pads
- Acoustic insulation
- Thermal insulation
- Insulator for prevention of cold welding of metals
- Filler in sintered "soil" cement
- Fine springs
- Packing material
- Strainers or filters for industrial or agricultural use
- Electrical insulation
- Ropes for cables (with coatings)

[In Gujarat at M .S. Univ., Kalabhavan, Baroda, basalt fibers are used as a reinforcing material for fabrics, having better physicomechanical properties than fiberglass, but significantly cheaper than carbon fiber.] www.fibre2fashion.com/industry-article/3/256/new-reinforced-material1.asp

- Basalt brake pads? (no asbestos on the Moon)
<http://www.technobasalt.com/news/?id=14>

MMM Theme Issues: The Lunar Economy - Years 1-25 Dec 1986 - Nov 2011

<http://www.basalt-tech.ru/en/prospects>

Hewn Basalt (MMM's list)

- Heavy duty Building blocks
- Road paving slabs
- Heavy duty floor slabs
- Architectural pillars, headers, arches
- ^a Carving blocks for sculpture statues, other artifacts
 - lamp bases, mancala/oware boards, etc.
 - fountains, bowls, table pedestals, vases, etc.
 - statues, plaques, beads, bracelets, endless list

3) Properties of basalt From-- <http://www.islandone.org/MMSG/aasm/AASM5C.html>

Table 5.9.- Properties Of Cast Basalt

Physical properties Average numerical value, MKS units

Density of magma @ 1473 K 2600-2700 kg/m³

Density of solid 2900-2960 kg/m³

Hygroscopicity 0.1%

Tensile strength 3.5X10⁷ N/m²

Compressive strength 5.4X10⁸ N/m²

Bending strength 4.5X10⁷ N/m²

Modulus of elasticity (Young's modulus) 1.1X10¹¹ N/m²

Moh's hardness 8.5

Grinding hardness 2.2X10⁵ m²/m³

Specific heat 840 J/kg K

Melting point 1400-1600 K

Heat of fusion 4.2X10⁵ J/kg (+/-30%)

Thermal conductivity 0.8 W/m K

Linear thermal expansion coefficient

... 273-373 K 7.7X10⁻⁶ m/m K

... 273-473 K 8.6X10⁻⁶ m/m K

Thermal shock resistance 150 K

Surface resistivity 1.0X10¹⁰ ohm-m

Internal resistivity 1.0X10⁹ ohm-m

Basalt magma viscosity 10²-10⁵ N-sec/m²

Magma surface tension 0.27-0.35 N/m

Velocity of sound, in melt @ 1500 K 2300 m/sec (compression wave)

Velocity of sound, solid @ 1000 K 5700 m/sec (compression wave)

Resistivity of melt @ 1500 K 1.0X10⁻⁴ ohm-m (author's note--this is of importance to magma electrolysis which requires an electrically conductive melt)

Thermal conductivity,

... melt @ 1500 K 0.4-1.3 W/m K

... solid @ STP 1.7-2.5 W/m K

Magnetic susceptibility 0.1-4.0X10⁻⁸ V/kg

Crystal growth rate 0.02-6X10⁻⁹ m/sec

Shear strength ~10⁸ N/m²

4) Gallery of Basalt Products

MMM Theme Issues: The Lunar Economy - Years 1-25 Dec 1986 - Nov 2011



Cast Basalt Pipes

With unequalled abrasion-resistance, such pipes and chutes will be **prerequisite** for all moon dust handling industries, even for oxygen production. Putting a starter base in the highlands (both polar areas are in highland areas) would mean such pipes and other moon-dust handling equipment would have to be imported from Earth, and, of course, that other useful basalt-based products would be unavailable.

Early basalt industries and products could meet a significant percentage of outpost expansion needs, cutting the cost of what must be brought up from Earth significantly.

The North Polar area is significantly closer to the basalt-rich maria than is the South Polar Area. As we need both access to water and a way to cut down on imports, the North Polar Area clamors for attention.



Cast Basalt tiles (from Czech Republic)

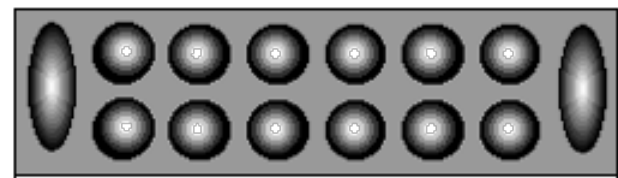

Hewn and carved basalt: a planter; blocks, a scarab, a Mancala game set

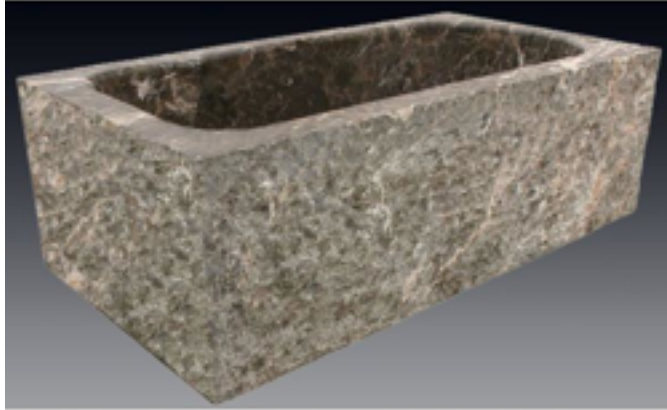

A bathtub

Note: The above are individually crafted items. Production items include pipes and tiles of various kinds.

Basalt: What Does All This Mean?

By Peter Kokh and Dave Dietzler

The cute things such as what you can carve out of solid basalt, aside, the essential message is in the abrasion resistance of basalt vs. the very abrasive nature of moon dust out of which we are going to have to make as much as possible. The name of the game is to produce locally on the Moon as much as possible of local frontier needs, and to develop export markets for those things, to defray imports on the one hand, and to earn credits to import what they cannot produce on the other hand.

Our Thesis: A lunar basalt industry is **pre-requisite** to any other lunar materials industry. Unless we prefer to bring from Earth, all items needed to handle abrasive material such as moon dust,

Lunar industrial settlement must have access to basalt: We believe that we must start in the maria, preferably along a mare/highland coast with access to both major suites of lunar material. The Lunar North Pole is some 600 miles from the nearest such coast – the north shore of Mare Frigoris. The Lunar South Pole is more than twice as far removed from the nearest such coast, the south shore of Mare Humorum.

Despite the advantage of more hours of sunlight, and eventually recoverable water ice, **starting at either pole could be an industrial dead end.**

Yes, access to water is essential, but most of us interested in lunar settlement, before the possibility of finding water ice at the pole became a common hope, were determined to launch lunar settlement anyway. We would harvest solar wind protons from the moon dust and combine them in fuel cells with oxygen coaxed from the same soil, to make water and extra power.

Having to do this, despite the now-confirmed reserves of water ice at the poles, may be a good thing, as it will prevent the rape of water-ice for the production of rocket fuel, and thereby preserve it for future lunar settlement needs including agriculture and biosphere. Yes Liquid Hydrogen and Liquid Oxygen are the most powerful fuels now in use. But 1) we don't need that much Isp to rocket off the Moon, or to hop from here to there on the Moon, and 2) we should be more concerned with developing more powerful fuels anyway, including nuclear fuels.

The polar water ice is at cryogenic temperatures, and extremely hard. Harvesting it in darkness at the bottom of steep crater walls will not be easy, and unless done entirely robotically, could be a very risky occupation. That it will be easy to harvest is myth #2. Myth #1 is that the sunlight at the poles is eternal. Honest estimates are that sunlight at any one spot is available only 76% of the time at the South Pole, and possibly 86% of the time at the North Pole.

MMM Theme Issues: The Lunar Economy - Years 1-25 Dec 1986 - Nov 2011

That means for 52% of the nightspan at the South Pole and 72% at the North Pole. We must still bite the bullet and learn to store dayspan power for nightspan use for 100% of the nightspan, a factor of 2 times as long at worst. Then we can go anywhere, including places where a more complete suite of mineral assets are available, including possible gas deposits elsewhere.

The critical role of basalt is so fundamental to success that we must rethink our destinations.
DD/PK

MMM # 235 May 2010

Successful Opening of a Lunar Frontier Will Require More Than One Settlement

By Peter Kokh

An overwhelming percentage of lunar advocates, both professional and enthusiast supporters, assume that “the” lunar outpost will be at one of the Moon’s poles, with the South Pole the current favorite. We have many times stated our objections to this location on these grounds:

- The **available sunlight** is not full time, and so we must learn to store power for use when sunlight is not available. So why not learn to do this for as long as two weeks, which would enable us to go anywhere
- **Water is essential** and would be costly to support and at the poles water ice is available. In fact what is there is at cryogenic temperatures and not a resource that we can expect to tap near term
- The **temperatures at the pole** (excepting permanently shadowed crater bottoms) are moderate. But we have already endured “mid-morning” temperatures on the Moon during the Apollo days. Being “afraid” (let’s call a spade a spade) of nightspan cold and dayspan heat is not a trait that bodes well for us as pioneers. We must learn to live in conditions that apply globally on the Moon, or just forget about it.

But from the vantage point of the Moon Society’s declared vision statement, **“formed to further the creation of communities on the Moon involving large-scale industrialization and private enterprise” the choice of “a” site is by itself “out of order.”** Why? Because the list of resources that will be needed for such an ambitious goal, are not to be found in any one location on the Moon: not at the poles, not at any other single location.

We owe it to our own stated commitment to start at a place from which we can easily expand. The South Pole is more highland-locked than is the North Pole, where twice as much water ice seems to be available. But we will want to tap resources that are more abundant in the maria as well as those more plentiful in the rugged highlands. But not all maria areas are equally endowed.

Some maria and mare-fringe areas are rich in KREEP deposits, that is, in Potassium (K), various rare earth elements (REE) and Phosphorus (P). Other areas are rich in ilmenite, an iron-titanium-oxygen mineral. Others are richer in uranium and thorium, which could support a lunar nuclear fuels industry. Then there are special places like the Marius Hills, which may contain volcanic volatiles, which could be exceedingly important industrially and biospherically.

Helium-3, if ever fusion based on this isotope becomes a near-term reality, is to be found virtually everywhere, but seems to be especially concentrated in ilmenite rich mare areas.

It seems that for a really successful industrialization, one as self-reliant as possible (some imports will be needed), we will have to set up shop in several locations, and, yes, that includes at least one of the poles, the north pole being the most promising on at least three counts: twice as much hydrogen (implying) water as at the south pole, more water-ice as opposed to frozen regolith with a low water content, and less than half the distance to the

MMM Theme Issues: The Lunar Economy - Years 1-25 Dec 1986 - Nov 2011

nearest mare coast, the north coast of Mare Frigoris. There is reason to start outposts on the farside as well, both industrial reasons, and scientific ones.

We should factor in locations that will be highly attractive to tourists. At first, any place that is “on the Moon” will do. But as tourism grows, the demand will grow for especially scenic areas, and they abound. Some tourists will be content to land, look around, and leave. But more and more the demand for overland excursions will grow strong. New tourist targets will at first be handy to new industry-focused settlements. But in time, we will see them sprout up in non-settled areas. Different locations will offer different recreational opportunities as well as changes of scenery

Now precisely because sites with special mineral resources will produce different products, they may also give rise to different arts and crafts, not just for frontier settlement enrichment, but to spur trade between settlements as well as to become more attractive to tourists, both those from Earth, and those from other lunar settlements – pioneers who need a vacation and change of scenery!

On Earth, trade was essential both for the development of local economies, and for slowly bringing all parts of the world into mutual contact. If we look back in history, trade has been absolutely essential, and probably the greatest single stimulus to the development and evolution of material cultures. Trade created incentives to build new highways, to improve transportation vehicles, to open new areas. Below is a map I found online of trade routes through Asia that have been key to the development of civilization.



What has all this to do with where we are now? A lot! The Bush–NASA plan was to open an outpost. Yes, NASA has always been aware of the potential for more, but it has not been tasked by the government to explore and develop those options. Thus the NASA plan was designed for a “low flight rate” transportation system in which cost was not an object, virtually guaranteeing that a first lunar outpost would remain the sole one, and that it might not even become truly permanent.

Personally, I have been greatly encouraged by the change in direction. While the government-focus may no longer be on the Moon, the technologies now to get attention will lead to better, cheaper, more efficient transportation systems, with considerable commercial participation, and even leadership. Now this is what we need to truly open a frontier. “A” lunar “outpost” has never been the goal of The Moon Society, nor of the National Space Society for that matter.

Yet there are many enthusiasts, who (a) would settle for a token outpost, and/or (b) are not confident of the abilities of the commercial and private sector to open the lunar frontiers. Face it. NASA cannot and will not open the Moon. Now we have a real chance that this will happen, and maybe even sooner. PK

MMM # 237 August 2010

Research & Development Projects For an International Lunar Research Park
By Dave Dietzler, Moon Society St. Louis, with contributions from others

MMM Theme Issues: The Lunar Economy - Years 1-25 Dec 1986 - Nov 2011

The Industrialization of the Moon and Earth orbital space offers these R&D opportunities:

- Helium-3 fusion fuel
- Lunar power beaming systems
- Solar power satellites
- Trans-continental and trans-oceanic power relay satellites
- Large high-powered GEO telecommunications platforms
- Space-based defense systems
- Asteroid deflection systems
- Development of Mars exploration and settlement technologies
- Materials and propellant for ships to Mars and elsewhere in the Solar System
- Materials for orbital factories and settlements
- Scientific research including astronomy, planetary science and SETI
- Development of robotics and spacesuit technologies
- Tourism and sport
- Media production opportunities (space-based reality/documentary television)
- Advances in Mining, manufacturing and ISRU
- Advances in robotics/telerobotics for space and terrestrial applications
- Advances in compact/miniature industrial automation
- Advances in large-scale distributed systems automation
- Advances in nanotechnology
- Advances in artificial intelligence
- Advances in renewable energy technology
- Advances in fiber and wireless telecommunications technology
- Advances in microprocessor solid-state data storage technology
- Advances in modular building technology for space and terrestrial applications
- Advances in hydroponics, mariculture, microbe, insect and small animal farming
- New on-orbit manufactured products based on space environment processing
- Employment/economic stimulus through orbital industrial development
- New in-space remote data vault facilities

Investment

Investors are key to the success of space Industrialization. Private stockholders, banks and governments will not put up their money for space industrialization projects without solid proof of their viability. Theoretical or experimental devices shown to work on Earth, even in simulation chambers, are not going to attract the financing that machines tested and proved out in the real world of the lunar and orbital environment will.

We propose the creation of an International Lunar Research Park to test the limits of man and technology on the Moon and in outer space. Not only do we seek scientific and engineering data, we seek to determine the cost effectiveness of various technologies in the real world.

Governance

Any single government or corporation would not own the ILRP. An international body similar to a "port authority" would control an ILRP.

- Various entities would own or rent facilities combined with common facilities like life support, command centers, a landing/launching pad, power supplies, etc.
- The core of the base that supplies these basics - Life Support Systems (LSS), power, command, etc. would be owned and operated by the base authority that charges fees for services.
- Private contractors--governments, corporations, universities and perhaps even hotels would plug their laboratory, shop and habitat modules into the core structure.

MMM Theme Issues: The Lunar Economy - Years 1-25 Dec 1986 - Nov 2011

This plan will reduce the upfront costs to the contractors who rent or own modules where they do their work. Wheeled vehicles and sub-orbital rockets would also be available to contractors by lease or rental plans, for exploration and prospecting on the Moon.

Research

At the ILRP research will be done to investigate whether mining and manufacturing on the Moon to make products for lunar and orbital industry rather than rocketing everything from Earth has more benefits than drawbacks, especially when finances are concerned. The technologies that are most cost effective will be determined before massive investment in large-scale space industry occurs. Research will also determine what the best kinds of lunar resources are, the cost effectiveness of their acquisition and their location.

Locations

There are several options with distinct advantages for different sets of research directions. Various groups of collaborating contributors might establish ILRPs at select locations. Any "The" in "ILRP" will hopefully be temporary

Areas of Investigation - Science

--**Astronomy**—telescopes could be built on Earth and rocketed to the Moon where they will have no atmospheric distortion to deal with. Eventually, huge telescopes would be built on the Moon from on site materials and these could be used to hunt for potential asteroid impactors and Earth-like planets orbiting other stars.

--**Lunar geology/prospecting**—ground truth probes into ice containing polar craters, deep bedrock core sampling, crater central peak sampling, seismic studies and drilling near volcanic domes to search for pockets of volcanic gas, lava tube exploration, investigation of magnetic anomalies like Gamma Reiner, Mare Marginus and Mare Ingenii

--**Bio-medical**—one of the chief areas of study will be the effect of low gravity on humans, animals and plants. Methods of coping with muscular and bone atrophy like sports, exercise, special diets, and medications must be studied.

[Editor's comment: The above is but a general report. To date, ILRP brainstorming has gone into depth on several topics. You can follow on this google group website;

<http://groups.google.com/group/international-lunar-research-park> (requires google username, password) ###

MMM # 238 September 2010

"In this decade" - JFK - 3 words that won us the Moon Race, but which have hamstrung us ever since – Editorial, PK

When President John F. Kennedy gave his famous "We choose to go the Moon" speech, these three fateful words torpedoed Wernher von Braun's plan. Sure he got to be in charge, but it was no longer his tune to which we would march. We could not delay achievement of the real goal, beating the Russians, and Oh, by the way, we will visit the Moon To set up a logical infrastructure along the way so that if we planned to stay, we could do so with an economical space transportation system. We were in a race, and the Moon was just a handy goal, dispensable once met. We would not delay the race to build an orbiting depot and assembly station. We would never have gone to the Moon as all, if it were not a way to trump the Russians big time, at their own game.

Those of us who were around at the time, when Nixon (not Congress) pulled the plug on "Kennedy's thing," were disappointed to be sure. But **Saturn V was not the right vehicle and transportation system on which to build a sustainable Moon venture that included a permanent and growing presence.** To stay, we would have had to pull the plug on Saturn V, which we did anyway, and start with a transportation system that involved logical nodes. And so

MMM Theme Issues: The Lunar Economy - Years 1-25 Dec 1986 - Nov 2011

began the campaign to convince President Reagan to give NASA a new goal, building a space station.

Well, we lost that one too. We got a space station of sorts, but it was a “yoyo space” thing, **downward looking at Earth, and not a outer-space oriented depot or assembly station**. It was even put in an orbit unfit to serve as a transfer point. Yes, that orbit was necessary to get the Russians to agree to partner with us, Clinton’s deal-clinching strategy to keep Russian scientists gainfully employed rather than out there looking for work in nations with mischievous intentions. Yes, the Space Station has done great things, and kept space in the public eye. But it is **boundary layer space, not the outer space that includes the Moon and planets and beyond**.

Once again the space community mounted an effort to get the government to consider going back to the Moon. Both Bushes came up with flawed plans. By then **NASA only knew one way to do the Moon, the wrong way**. So along comes Mike Griffin, who gives us a Saturn V substitute, a way to get to the Moon without building the infrastructure that might allow us **to stay!**

Let’s stop blaming Obama for halting what was a farce in the first place. Let’s stop cheering on Senators who would reverse Obama’s decision. If we want to return the Moon “to stay,” we have to abandon **Space Transportation 1.0**. We have to start with a clean slate, and brainstorm **Space Transportation 2.0**

What we have been trying to do for over forty years has been a pathetic reenactment of the tale of Sisyphus, the mythical Greek figure who kept trying to push a big rock to the top of a hill, only to lose the battle and watch it roll back to the bottom, retrace his steps and try again to push it to the top. We did not settle the west that way. We did not set out from the East Coast with a gigantic 50 ft wide half a mile long Conestoga wagon pulled by a team of a thousand horses. No, we built places along the way, St. Louis, Kansas City, Omaha, Denver, Salt Lake City, etc. At these stops we could replenish all our supplies, even personnel. At each stop, we dropped off things (passengers too) needed there and picked up new supplies, fresh people. Every waypoint made the next waypoint doable and at a reasonable cost. Going from Sacramento to San Francisco, the last step, was no more expensive than going a similar distance much further east.

So how do we take a page from the mid-1900s, a century and a half ago? It is pathetic that it is taking so long to learn what is really an obvious lesson!

Waypoints on the Road to the “Moon to Stay”

Let’s back up a bit. No I am not a rocket scientist. But rocket science is the problem. Why, because it is impatience that is always the problem. Building bigger and more powerful rockets is just making it more expensive to go nowhere.

It would seem that low Earth orbit is waypoint one. But I think it would pay to revisit how we launch from Earth. The most expensive thing is getting off the ground, and vertical launch is the most expensive way to do that. Fly back boosters, even rocket sleds, to launch horizontally to a level where the atmosphere is much thinner, need to be revisited. Always keep in mind that impatience is the enemy, the chief way we defeat ourselves in whatever we do. It simply should not take that much oomph to get us into orbit, or to the point where a smaller second stage could take over from a smaller first stage and successfully get the same payload into space. The masculine power trip way is not only not always the best way; it is almost always the worst way. So the first way point is the in transit level at which atmospheric resistance significantly drops off.

Low Earth Orbit

We all know how useful low Earth orbit is. It is a great place to study the Earth. Our remote sensing and weather and navigational satellites have given us a much better understanding of our home planet. And the International Space Station has helped as a platform. It is also a great place to assemble things to large and/or to heavy to be sent up in

MMM Theme Issues: The Lunar Economy - Years 1-25 Dec 1986 - Nov 2011

one payload. To date, except for the Space Station itself, which proves the point, we have tried to avoid in-space assembly by building ever-bigger rockets for ever-heavier and larger payloads.

What we haven't yet got right is that every part of a rocket that makes it to low Earth orbit, could have been designed "transformer style" to serve as components for something to be assembled in orbit. We just throw that "stuff" away: farings, spent stages, External Tanks!

For every ton of satellite mass in orbit, we have thrown many tons away that could not be integrated into something useful whether larger platforms, assembly and repair facilities, additional space stations or facilities for space stations. But then we are a throwaway people. Like our simian predecessors, who seemingly can't be house-broken, we apparently can't be planet-broken; it is easier to throw away and to trash than to reuse and reassign items and materials that have done their initial job. Had we not been so macho, and had been into husbanding everything that makes it into space, we could be decades ahead of where we are now, and probably without a space debris problem of such magnitude.



Impossible? If you think so, perhaps your imagination has become fossilized. Hold a design competition for ideas on what we can do with this or that throw-away item and prepare to be amazed at what still flexible minds can imagine! Get with the program or get out of the way. We'd all still be in the stone age if it were not so.

Geosynchronous Orbit

Now we get to where it gets real fun! Perhaps most of us do not realize the scale of Geosynchronous orbit. At 23,000 miles above Earth's surface, 27,000 miles above its center, it is $2\pi r$ or 170,000 mi. (230,000 km) in circumference. Yet, it is limited. We don't need our communications satellites slowly drifting into one another, so international agreement limits "stations" to 2 degree intervals. Dividing 170,000 by 180 gives us a spacing less than a thousand miles apart. But we already have well over 180 objects in GEO. And if and when we start building solar power satellites in GEO, and these things will be large, the situation could become dicey.

One way to alleviate crowding would be to build giant platforms that could provide power, station-keeping and repair services to dozens, hundreds, or even thousands of individual communications and TV relay units. Where would we get the materials to build such platforms? We need not build more GEO-bound rockets, but only design their rocket casings in a way that, again, "transformer-style," can self-unfold into platform strut sections. Maybe we need to mandate our rocket scientists and engineers to watch more Saturday morning cartoons - some of them probably never heard of the "transformers." Well, the kids and toymakers all know, so maybe when they grow up, they can turn things around.

Ultimately, of course, building materials for GEO platforms and SPS stations, can be shipped down from the Moon at much less expense than up the shorter distance from Earth. IF GEO is to be the linchpin of the 21st century economy (up from \$250 billion per year of economic value to \$250 trillion), lunar resources will be the principle enablers. (Mars will contribute nada, zilch.)

The Earth-Moon L1 Gateway

MMM Theme Issues: The Lunar Economy - Years 1-25 Dec 1986 - Nov 2011

This is the next waypoint, the “Sacramento” stage if you will. And in similar fashion, this gateway can be built up from components needed to get that far, but not going the rest of the way to the Moon’s surface.

We will want an L1 Space Station with storage, even warehousing capacity, vehicle repair and maintenance facilities, fuel storage, cargo storage for trans-shipment, crew quarters for personnel in transit. L1 will grow apace with facilities on the Moon’s surface, into a major transfer and service spaceport in the sky.

If L1 doesn’t grow, neither will the lunar frontier. Reuse of every last item that arrives there not going further, is the key. See our slide show on L1 growth:

www.moonsociety.org/spreadtheword/pdf/L1phases.pdf

The Moon’s Surface

Nor does our “transformer” routine stop at L1. Every part of a ship that lands on the Moon, and which is not needed for a return flight (100% if it is an unmanned cargo ship) should be designed for reuse or cannibalization on the Moon – down to the last strut, landing pad, fuel tank, --- everything, not just what’s in the cargo hold – and that goes for packaging materials as well. To paraphrase a colorful description of rural southern cooking, using every part of the pig except the squeal (and maybe finding a use for that as well.)

Now I have just offended those who believe that reusability is the key to economy. No, not if you mean reusing the same thing over and over for its original purpose. To do that you have to get it back to its original port and that is wasting fuel. Second, by reusing as is, you do not benefit from the economy of mass production. We don’t need ten reusable rockets that get used a hundred times. We need a thousand rockets that get used only once, as a rocket, but then are put to permanent use taken apart and transformed into something needed on the frontier. Old timers will remember the World War Liberty ships, which we turned out cheap by the hundreds. Mass production and total reuse of materials at a destination – that’s economy on steroids, if you will!

Yes things should be reused, but as materials, not as originally assembly components. We have to get into this new way of thinking about things and their utility. Look at a lander’s legs and pads, and see a mobile crane! We may have to tweak original designs to get the most reuse potential out of them. And this redesign may cost some, but the rewards for reusability will pay off handsomely. Let’s sponsor and run contests annually for the most innovative reuse of all these things used only once in transit. Let the young people clear the cobwebs in our older brains! We will fail if we do not pass the torch!

Summing up “Space Transportation 2.0”

- # Every item that leaves Earth surface should be designed for reusability of its constituent parts or materials.
- # Components should be designed to serve some new function or purpose at the way station at which their original function has been achieved
- # Power is less important than economy and reusability
- # Nothing that can be used at a way station should be sent back down the line Earthwards. It is better in the long haul to keep sending up new rockets and rocket components that can be put to new use up the line, than to return them back down the line – false economy
- # Complete Hardware Utilization Mission Architectures = “CHUMA” (thanks to Dave Dietzler for this acronym)
- # Everything in the sacred traditional way of doing things should be reexamined in light of this new paradigm.
 - **The goal is not to return to the Moon.**
 - **The goal is not to return to the Moon to stay.**
 - **The goal is to return to the Moon and keep growing a lunar frontier civilization which in turn will feed Earth’s needs in GEO and elsewhere and help us all rejuvenate and preserve the Eden that Earth once was. We are going to have to travel a lot of light years to find another like it.**

MMM Theme Issues: The Lunar Economy - Years 1-25 Dec 1986 - Nov 2011

If this seems absurd, check out this report: <http://www.foxnews.com/story/0,2933,529059,00.html>

We have to quit saying “we can’t” when we haven’t really tried.
To the Moon, to stay! PK

For the Sake of Science, Science should not be in the driver’s seat on the Moon

Editorial By Peter Kokh

It may seem irrelevant now that NASA has been redirected away from establishment of a permanent structure on the Moon, it begs discussion. The lunar science community has strongly favored a south pole location because it lies on the rim of the vast South Pole–Aitken basin, the deepest on the Moon, most of it in the farside southern hemisphere. These scientists see a South Pole site as a jumping off point for overland expeditions that would probe the SPA’s secrets.

What’s special about the SPA other than it being the Moon’s deepest basin? There is an expectation among some that there are mantle materials to be found here and there on its surface. On the nearside, the mantle lies miles below the surface. What seems puzzling is that scientists are supposed to be “smart.” The Apollo crater in the NE part of the SPA, where the deepest areas are to be found, is o a thousand miles from the pole, across rugged terrain. As moths that need the mythical “eternal sunshine” they would not get far from the pole before they would have to turn around to get back before dark.

That is not our point. To these scientists, establishment of a permanent lunar frontier is a low priority if it has any priority at all. Yet, the more people on the Moon, in the more places, for an open–ended period, the more science will be supported and in the more places. If Europe had sent a dozen science expeditions to both North and South America each, but never settled, how much would we now know about these two continents compared to what we, as inhabitants, have learned over the centuries? These scientists, brilliantly focused in the short term, are obviously myopic when it comes to looking further ahead, their advice needs to be weighed against other more practical considerations.

We do need lunar science to help identify key locations on the Moon with the various resource connected mineral resources. The lunar frontier must be global in character. The South Pole, as attractive a site as it seems to be, has some severe drawbacks. The polar ice may not be a near–term resource. That some very rocky anything–but–flat areas get a lot of sunshine is irrelevant if there are no “buildable” locations nearby, locations large enough to support considerable expansion. And as the pole is so atypical, learning how to erect and maintain a base there does nothing to help us globally.

Some destructively impatient lunar mission advocates have convinced some U.S. senators that the Constellation program should be reinstated. This effort is seriously misguided. Why spend our limited funds on a program to “fly & flunk” when we should be laying foundations for a Moon Program that will patiently and deliberately phase in permanent human settlement based on industries that will help tackle Earth’s most important problems: environmental degradation and limited clean energy reserves.

It has become more important to some lunar enthusiasts to see something happen in their lifetime than to face death, not having seen the favored frontier open, but knowing that we are on the right track to doing it right, doing it to last, doing it to fulfill all its promised potential.

PK

Could the Best Place to Mine Asteroids be on the Moon?

By Peter Kokh

Hey, the asteroids are way out beyond the Moon! But how do you think the Moon got all its craters? Volcanic origins were ruled out long ago. Yes, asteroids are “out there.” But now and then one is gravitationally dislodged into the inner solar system, and sometimes, the Moon or Earth itself is in the way and splat!

The amount of asteroid-sourced material in the moon dust or regolith may be relatively small. Much of the impacting asteroid material may have been thrown out into space. But some must remain. Now most of the near Earth asteroid objects seem to be of the stony type, and we have enough rock powder on the Moon! What would be of interest are left-overs from metal-rich asteroids. In general, the Moon is deficient in some of the elements most needed for a technological civilization: copper, zinc, gold, silver, and the most prized element of all: platinum, involved in some 25% of all current manufacturing processes. It is the catalyst of choice for hydrogen-oxygen fuel cells, for example. Copper is so important that a 1% ore on Earth is considered “rich.”

PGMs – Platinum Group Metals – are the focus of the recently published science fiction novel by Bill White, a Moon Society member: “Platinum Moon” which was reviewed in the August issue, MMM #237. PGMs were also the focus of Dennis Wingo’s work “MoonRush.”

Why not mine Platinum and associated metals on asteroids where they are concentrated? John Lewis and many others talk about this extensively. But there are a few awkward details that they aren’t sharing with us.

1. **There is an “inconvenient” Catch-22 in Orbital Mechanics that says the closer two bodies** (Earth and a target asteroid) **are in period** (the time they take to go around the Sun, **the farther apart on the average are the launch windows from one to the other.** The wait between launch windows between Mars and Earth in either direction is some 25+ months. Between Earth and a really close NEA or NEO that window may open every two decades or longer! The upshot is that NEOs are hit and miss “targets of opportunity” at best.
2. **But the delta V, the amount of change in velocity (or powered acceleration needed is very low.** Again a Catch-22 – **the lower the delta-V needed, the longer the trip from one to the other.**
3. **But you save so much fuel!** Well, that’s okay if you are sending robotic prospectors and miners. But if you are sending humans, **the extra consumables you will need to send along will probably out-weigh the saved fuel.** The journey could take many months, and the wait for a window home could be years, and then the long trip back.

No one told you that? Hmm! I wonder why? We are not opposed to exploring, mining, and even settling the asteroids. In fact there have been many articles about asteroids and the possibilities for using them in past issues of Moon Miners’ Manifesto. We have gathered them and republished them in a special Asteroids theme issue. This is a free PDF file download from www.moonsociety.org/publications/mmm_themes/

Our point is that lunar pioneers can’t afford to wait until asteroid mining has developed to the point where shipments from the Belt or elsewhere can fill the settlements’ needs for these metals. There must be areas on the Moon where these metals are to be found in amounts worth prospecting for and extracting. No Lunar orbiter yet flown has been equipped to find these metals, especially in small local concentrations.

What do we need to detect and mine PGMs

Until now, the instruments chosen to fly on lunar orbiters have been selected to map concentrations of key elements we know to be fairly abundant on the Moon: iron, aluminum,

MMM Theme Issues: The Lunar Economy - Years 1-25 Dec 1986 - Nov 2011

magnesium, titanium, thorium; and it is fair to say that the driving curiosity has been what the geography of these concentrations says about how the Moon was formed and how it got to its present condition, rather than a search for “resources.” Planetary scientists are in charge, and that is appropriate at this stage of the game.

The only element that has also been the target of orbital mapping as a resource, is hydrogen, which together with overly abundant oxygen gives us water, water ice, and hydrates. But that is because, water is essential to outposts whether they get into the lunar materials industry business or not. Plus scarce water can be stolen from the precious lunar reserves for one-use non-recyclable exploitation as rocket fuel, when, in the Moon’s low gravity environment, other more abundant options are available.

Now some of the targeted elements have usual partners: where there is thorium, there is probably uranium and lead, for example. So we know more.

Additionally, Apollo missions 12, 14, 15, and 17 all found KREEP deposits, rich in Potassium (K), Rare Earth Elements, and Phosphorus primarily in the Mare Imbrium splashout zone. Lunar Prospector in 1998–9 mapped these deposits at low resolution.

Could future lunar orbiter instruments detect PGMs and other valuable but less common elements on the Moon? Both the resolution and sensitivity of the needed instruments would have to be very high. But as so much is at stake, even sketchy indications of where best to look with on the surface techniques would be most helpful, by weeding out extensive areas where concentrations are lower. That said, to the extent that PGMs are a gift from the sky and not from the lunar interior, a statement that may not be totally correct, then their geographic concentrations should not follow well-known surface terrane “provinces” such as the highlands and/or maria. Nor will they be found in connection with certain types of craters, as crater types go by size, density, speed, and impact angle of the object creating them, and not by the object’s makeup. That said, after a few PGM concentrations are found, it is possible that we will detect a pattern that will suggest where else on the Moon, the “prospecting prospects” are promising.

Do we need an army of human prospectors? This will be tedious work, and until definite concentrations that might be worth “mining” are found, expensive human efforts would be unwarranted and wasteful. So what can we do?

Orbiter instruments that successfully find some evidence of PGMs should be reflown on orbiters with eccentric orbits that carry them very close to the surface, say 10 kilometers (6 miles) or so, and keep adjusting the orbit until the entire Moon, farside as well as nearside, is mapped to produce the first crude map of PGM abundances. This map may suggest where to look on the surface itself. And here we need robotic rovers.

But because we will need many such assistants, and because there is an area as big as Africa and Australia together to cover, we suggest micro-rovers, working in teams, what I have called “robo-ants.” I wrote about these handy critters way back in MMM #45, May 1991, almost twenty years ago. An updated version of this article was recently published in our Moon Miners’ Manifesto India Quarterly, issue #5, a free download at:

www.moonsociety.org/india/mmm-india/ or directly at:

http://www.moonsociety.org/india/mmm-india/m3india5_Winter2010.pdf

We need to develop these handy “social mini-bots” anyway. They will come in handy as exospeleologist scouts, creating initial surveys of the interiors of lava tubes on Moon and Mars, and going elsewhere in terrain difficult for humans to traverse, and scour, whether in spacesuits or pressurized vehicles. Now of course, human guidance and teleoperation of these handy assistants from a nearby pressurized field vehicle is certainly an option.

PGMs have not been confirmed on the Moon and that is no surprise. We have not fielded the equipment and technologies needed. But we have every reason to believe that they are there, and that for the very practical reasons outlined above,

The Moon is the best place to mine Asteroid wealth!
The time to start planning how to do this is now! PK

A N A V A T A R M O O N B A S E ?

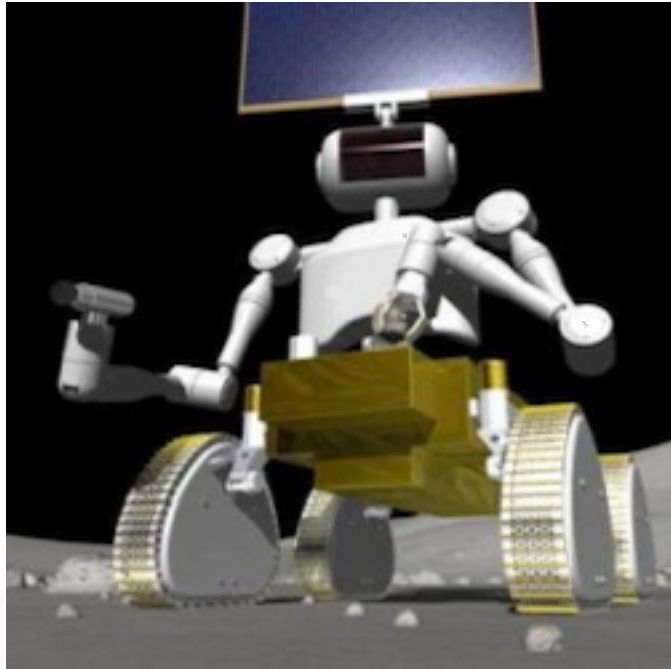

Japan & Russia have Separate Ideas

http://news.cnet.com/8301-17938_105-20006075-1.html

Above, a JAXA illustration from this report – By Peter Kokh

We have been talking for years about the need to automate and teleoperated as many “routine” tasks on the Moon as possible, in order to free humans on the scene to do what only they can do. Human labor on the Moon will be very expensive in terms of transportation logistics and life support. Workers on Earth, at the controls of teleoperation and telepresence devices will be considerably less expensive, and as they hand over the controls to relief personnel, the devices they control on the Moon can keep on doing their thing without relief.

Of course, there is a limit. Someone has to fix and maintain the teleoperated and telepresence-controlled devices on the Moon, and come to their assistance should they get stuck, or otherwise befuddled.

JAXA would go further, butting robotic avatars on the Moon that would allow scientists on Earth to see, pick up, and feel, and probe rock samples via telepresence. Humans would still be needed, and more of them than the devices they control, as they pass over the controls at shift rotations and for lunch breaks so that the work on the Moon can proceed “24/7.” Telepresence operators would experience what it is like to be and operate on the Moon’s surface, at least to some extent.

This kind of “takeover” may well happen for many occupations on Earth as well. No one will be laid off – they will just get to do their thing from the comfort of home or vacation settings. Less time spent traveling to and fro, less gasoline consumed. Of course, there will be some displacements. That is inevitable.

Background Reading

Some of these links include relevant videos

<http://spectrum.ieee.org/robotics/industrial-robots/when-my-avatar-went-to-work/0>

<http://spectrum.ieee.org/static/telepresence>

MMM Theme Issues: The Lunar Economy - Years 1-25 Dec 1986 - Nov 2011

<http://spectrum.ieee.org/automaton/robotics/industrial-robots/051810-anybots-qb-new-telepresence-robot>

Call this development “**teleoperation 2.0**” if you will. The upgrade is that your eyes will see what your avatar sees; your hands will feel what it feels. For the teleoperator, this will at first be a thrill, then frustrating, as one gets used to the 2.5-second time delay – light can only go so fast! – But in time all this will become second nature. We get used to “magic” very quickly.

While it may seem that less people get to go to the Moon, more people will get to enjoy the “avatar experience.” But as there is a limit to what can be done effectively and efficiently by telepresence, every task assumed by a telepresence operator on Earth, means that a human crew member is freed for non-routine things. We won’t be sending less people to the Moon, but the ones we send will get to do more exciting, less routine things. The upshot is that the same amount of humans on the Moon will get to do more interesting work, as the routine tasks will be teleoperated from Earth.

Now on Mars, telepresence type robotics will just not work, given the 6-minute minimum time delay (when Mars is closest to Earth) to a 40-min maximum, unless, of course, we have a forward base in Mars orbit: a space station or an outpost on one or both of Mars’ two mini-moons. But more on how we will do this on Mars in our next **Mars** issue (every **March**, of course), MMM # 243.

The Russians are planning a “robotic” moonbase as well. But this seems to involve teleoperated equipment only, tasked with base construction, and not telepresence tasked with scientific exploration.

Beyond Telepresence to “Droids”

The next step is to make devices on the Moon autonomous, not only doing away with the time-delay, but substituting artificial intelligence for that of a tele-presence operator. But hopefully, Star Trek had it right, and the ‘droids will be tireless helpers, rather than replacements for humans. We can leave to them those tasks that are boringly routine, as well as those that involve substantial risk or danger, and or unpleasant operating conditions (the heat of high noon, and cold of nightspan; treacherous terrain, etc.)

One thing I can’t see, is droid replacements for my dogs! Or at least I hope to be long gone before that happens. I don’t mind my dogs owning me! Lol!

Site preparation tasks

Current thinking sees involvement of robotic and teleoperated machinery for site preparation tasks such as spaceport construction, grading of the site, digging trenches to hold modules, then covering them with moon dust shielding, or with blocks made from moondust, etc. In short almost everything necessary will be taken care of by robots and/or teleoperated equipment so that when the first crew arrives, they have a ready-to-move-in outpost, and they can concentrate on scientific exploration and experimental production of building materials from moondust ingredients, needed to manufacture more living space for base expansion.

MMM

MMM # 242 February 2011

Telepresence-operated “Robonauts” will revise all “Scenarios”

By Peter Kokh

At first impression, those of us who want to see human frontiers develop “and prosper” on the Moon, Mars, the asteroids and elsewhere in the Solar System may think that the emergence of robonauts threaten that dream. But quite the opposite is likely. These “stand ins” will pave the way at far less expense,

We have already integrated “teleoperation” of equipment” into our expectations. Japan and Russia, as well as our own Carnegie-Mellon robotics team, have suggested that site

MMM Theme Issues: The Lunar Economy - Years 1-25 Dec 1986 - Nov 2011

preparation and many construction chores could save substantial amounts of time and money. It costs a lot to put a human on the Moon! Humans are most effectively assigned to chores that cannot be teleoperated. Teleoperated equipment will allow humans to go to the Moon to begin at once to do what only they can do.

Enter the “robonauts” and telepresence! Here the human controller on Earth “sees what the robonaut sees, feels what the robonaut feels.” This is ideal for scientific tasks – for example, where it is not the size, shape or weight of a rock which is of interest, but its chemical–mineralogical makeup.” Robonauts can collect samples of special interest, freeing humans of that tedious chore, so that when they arrive, they can examine a pre–selected collection, without wasting hours and days in field work.

Robonauts do not need food, rest or relaxation. They can work around the clock, through a team of tele–presence operators on Earth. They do not get bored. Thus the quality of their work is more likely to be high. As to teleoperated equipment, there will be many chores which cannot be done into their manipulation tools, one of a kind chores, that could not be foreseen, or which will be so uncommon that it would not be cost–effective to further specialize those tools and programs. A robonaut with hands human–like in their degrees of motion, can use hand tools for a limitless list of special tasks. Robonauts can do things too dangerous or risky for human crews. T companions can relieve humans of all sorts of risky and tedious chores.

In his article “O’Neill’s High Frontier Revisited and Modified” blow, Dave Dietzler shows how the emergence of robotic technologies also radically changes that scenario of how solar power satellites will be produced and deployed. No need for hyper expensive Space Settlements, that could delay the construction of SPS systems by many decades. Humans will still be involved, in lesser numbers, with far lower thresholds of support.

To sum up, lunar resources are still a best bet to lower SPS construction and deployment costs, but the cost of accessing those resources will fall by an order of magnitude or more by reducing the amount of human workers involved.

Consider that a lunar settlement can begin very small and grow as needed, module by module. In Contrast, a Space Settlement has to be built to a set size, whether it is occupied by a starter crew, or at full capacity. Space Settlements have a built–in high threshold, greatly exacerbated by the insistence on Earth–normal gravity levels. PK

Role of Robonauts & Robots on the Moon once Humans have settled in to stay

By Peter Kokh

We have realized for a long time, at least since the early Apollo mission days, that radiation exposure on the Moon from cosmic rays and solar flares was a big problem. The week or so of unprotected vulnerability could be tolerated. But it would be better to provide some sort of shielding for persons intending to stay a while. Two meters of moondust overburden should protect those within habitat modules for stays up to a few months. But long term, 4–5 meters would be better.

We’ve known this for some time and most moon–base plans have some sort of shielding incorporated as part and parcel of the plan. This need has also made the possibility of locating human installations within lava tubes very appealing. These voids, whole networks of them, are common in the lava flow sheets that filled most large nearside basins, creating the maria (MAH–ri–a, singular MAH ray, mare) or “Seas.” But these handy hollows are not to be found at or near either lunar pole, both poles being located in highland areas.

The inspiration out of which the original Moon Miners’ Manifesto was born, was that while we had to live “underground”, we would not have to live like moles, as Robert A. Heinlein had suggested in his classic novel: “The Moon is a Harsh Mistress,” as there were ways we could take the sunshine and views “down under with us.” http://www.moonsociety.org/chapters/milwaukee/mmm/mmm_1.html

But surely we have business out on the naked, radiation–washed surface! We need to explore, to prospect for minerals, to build roads, to trade with other settlements! No people, and surely not the Moon’s people, will freely be virtually imprisoned full time. How do we handle this? Read on.

MMM Theme Issues: The Lunar Economy - Years 1-25 Dec 1986 - Nov 2011

Radiation Exposure Limits and Monitoring

Perhaps every Lunan settler or pioneer or visitor will be required to wear a wristband or other device that monitors one's accumulated radiation exposure. Those whose exposure is under set levels will be allowed to go "outside" - "out-vac" on the exposed, vacuum and radiation-washed surface for limited times, and on limited occasions.

Jobs and Careers

There are those in any population that feel most at home "outdoors" and/or "on the road." But living such a life-style - having such an occupation, could result in radiation sickness and even premature death. Unless!

There are three ways to sidestep this nasty fate.

- (1) Outside jobs could be managed from the safety of shielded habitat spaces, by telepresence operation of robonauts or avatars.
- (2) The cabs of over-the-road trucks, motor coaches, trains and construction equipment could be jacketed by water (somehow kept from freezing or boiling). The jacket need cover only that portion exposed to the sky.
- 3) Outside jobs could be filled by rotation from among a large pool of persons, who would do safe "inside" work most of the time. This would not suit those who wish to be out on the surface regularly, but such types could work in jacketed conditions as described in (2) above.



Above: a concept for a protected railroad passenger wagon to be used by frequent travelers at a "1st class" rate. Infrequent travelers could safely make overland trips without such protection.

We might expect to see some out-vac duties preferentially entrusted to robots and telepresence-controlled robonauts that can be put to work "24/7" without fatigue, boredom, and errors, and some to be filled by humans on restricted shifts, but from within the safety of shielded mobile cabs. Routine prospecting, mining, extensive construction, and road-building, are some of the high exposure activities that could be managed this way.

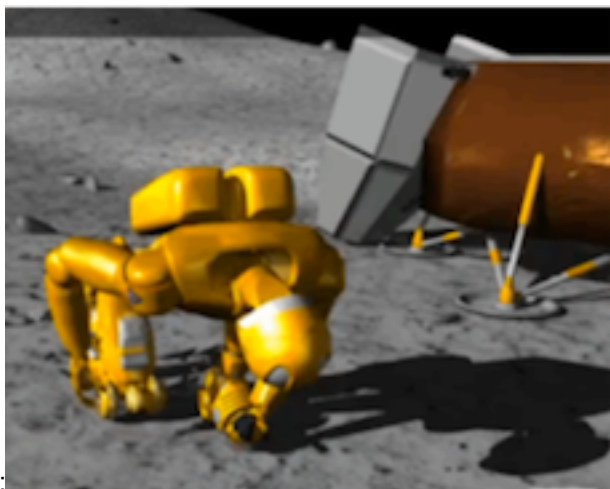

NASA-JSC:

Project M robonaut

Thus a truck cab could be shielded even if there were no need to shield the cargo containers. How is this different from human workers guiding deep sea well-drilling from the safety and comfort of a pressurized submersible at depths at which human divers could not

MMM Theme Issues: The Lunar Economy - Years 1-25 Dec 1986 - Nov 2011

work? Clearly, those who say we can't work out of our element, have already been proven wrong again and again. Wherever there is something to be gained, we will find a way to conduct our business safely.

Those who rarely travel by train or coach could ride in unshielded units at a bargain price, while businessmen who travel frequently could ride in shielded units at a first class rate. Common sense and a close watch of one's rem-exposure monitors, will allow most pioneers to enjoy an almost natural familiarity with the great lunar out-vac and with its magnificent desolation and spectacular sterile beauty.

Recreation and Sports

In this situation, out-vac leisure activities such as rock collecting, hiking, road rallies, camping out under the stars, and prospecting for the fun of it, would have to be exercised with caution and sparingly. We won't become "Lunans" until we are "at home" on the Moon, and that means "at home" out on the surface as well as in cozy urban burrows. Even so, the availability of a mobile shelter when not actually engaging in the out-vac surface activity in question would make for good policy.

As to sports, the out-vac provides not only one-sixth gravity, but also vacuum, and pioneers will invent interesting and fun sports for such conditions. But here too, there is a way out: pioneers could build a shielded but unpressurized stadium in which low-gravity vacuum sports could be played.

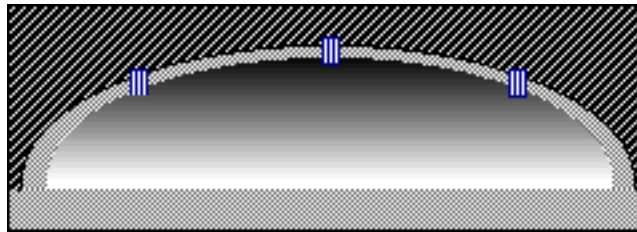

Cross-section of shielded but unpressurized sports arena

Are Demron-layer spacesuits be the answer?

Recently, there have been a flurry of reports that a new polymer fabric offers sufficient radiation protection. But Wikipedia introduces its article with the following warning:

"This article is written like an advertisement. Please help rewrite this article from a neutral point of view. For blatant advertising that would require a fundamental rewrite to become encyclopedic, use `{{db-spam}}` to mark for speedy deletion. (June 2009)"

"**Demron** is a radiation-blocking fabric made by Radiation Shield Technologies. The material is said to have radiation protection similar to lead shielding, while being lightweight and flexible. The composition of Demron is proprietary, but is described as a non-toxic polymer. According to its manufacturer, while Demron shields the wearer from radiation alone, it can be coupled with different protective materials to block chemical and biological threats as well. Demron is roughly three to four times more expensive than a conventional lead apron, but can be treated like a normal fabric for cleaning, storage and disposal. More recent uses for Demron include certified first responder Hazmat suits as well as tactical vests. Demron is proven by the United States Department of Energy to significantly reduce high energy alpha and beta radiation, and reduce low energy gamma radiation. When several sheets of Demron are laminated together the result is a much more powerful shield, though Demron cannot completely block all gamma radiation."

There is an enormous difference between the kind of radiation hazards found here on Earth such as exposure to radioactive wastes from nuclear power plants and exposure to high-energy cosmic rays coming from all directions of the space or the lunar sky.

In MMM #238 Sept 2010, pp. 4-5, "A Fresh Look at the Spacesuit Concept" we suggested a two-garment approach: an inner "skinsuit" counter-pressure suit, and a loose

MMM Theme Issues: The Lunar Economy - Years 1-25 Dec 1986 - Nov 2011

outer suit to handle thermal exposure and provide puncture proofing. Perhaps a Demron layer incorporated into such an outer suit would allow the wearer to stay out on the surface a longer time before accumulating “x” amount of radiation dosage. But Demron has not been tested in realistic space conditions in Earth-orbit much less beyond the Van Allen Belts. It may or may not help, but certainly won’t be a cure-all.

A lesson some have not learned

At the 2010 International Space Development Conference held in Chicago last May, a speaker confident of what he was saying, crossed off Moon and Mars as future settlement territory on the grounds of surface radiation exposure “unless we wanted to live underground full-time.” Nonsense. If there is one thing the history of the human Diaspora beyond Africa, and even within it, has amply demonstrated, it is that resourceful, ingenious, and determined people can learn to make themselves “at home” and comfortably so, in the most seemingly inhospitable environments. Settlers on Moon and Mars will defy the warnings of such persons, even as have the Eskimo and Inuit of our Arctic regions. “Where there is a will, there’s a way. And we will find ways to survive in environments much more unforgiving and hostile than Moon and Mars.

On frontier after frontier, we have been faced with new climate conditions, new geological and mineral resources, new plant and animal species. Where old tools did not work, or work well, we forged new ones that did. True, some frontiers would not support large populations. But everywhere, people have learned to live happy and productive and fulfilling lives.

Radiation will be a problem for those living and working on the Moon or Mars only until we have learned to deal with it “as if by second nature.” Sure Arctic and Antarctic temperatures can kill! But who would go outdoors in those places without adequate clothing and protection!

Lunar pioneers will soon learn what they can and can’t do in their challenging environments. More, they will continue to find new ways to push “this envelope” ever further and further, to the point few would see surface radiation as a game-stopper. Doing the right thing, the safe thing, will have become second nature. The pioneers will have become Lunans. And the same transition will occur on Mars and other even more challenging locations.

Take anyone “as they are” off the streets of Mumbai or Cairo and set them down in Antarctica, and we have a problem. But someone from Edmonton or Irkutsk might fare better.

Unlike specialized animal species, humans cannot be defined by their habitat. We are adaptable, and neither the Moon nor Mars defines the limits of that adaptability. We will learn to handle the risks of the lunar surface “as if by second nature” under penalty of death, just as the Inuit have adapted to the Arctic. We will not be at home on the Moon until we do.

To coin a word, we are a **prokalotrophic** species: **we feed on challenges**. And those who warn us that we “can’t” do this or can’t do that, do us all a favor, by spurring us on to prove them quite wrong. And in that sense, science-fiction stories, which can get pretty wild, do us a service. They make us, even if only some of us, confident and determined to spread the human ecumene – the human ecosphere – beyond the four corners of Earth, beyond the seven continents and the seven seas, to wherever our ingenious heavenly chariots will take us.

The Moon, as a humanized world, will become more interesting and nourishing a life-environment because we have accepted radiation-protection as a challenge. The more formidable the challenge, the sweeter the victory! We would still be in the caves or swinging from the trees if it were not so.

So thanks for the warning. “Bring it on!” **PK**

O'Neill's High Frontier Updated and Modified

By Dave Dietzler

Choosing the machines for the lunar industrial seed¹, designing them and building them will require years of careful consideration and a small army of engineers, but there is no fundamental scientific or philosophical reason that this cannot be done.

Introduction

It has been over thirty years since "**The High Frontier**"² was published and during that time most of the people I've discussed it with have agreed upon a modified version of things. In discussions and e-mails most of us have agreed that:

The 100 million ton plus space colony is out of the picture and most SPS assembly work should be done in GEO with teleoperated robots.

O'Neill and others focused on the space colony and kind of slighted the Moon.

They figured the mining machines and mass driver would be launched from Earth with low cost Shuttle Derived Vehicles landed on the Moon in pieces and assembled by a crew of about 50 Moon miners³.

Raw regolith would be launched into space where it was processed into metals for construction, oxygen for rockets and excess raw regolith and slag that would be used for space colony radiation shielding as well as mass driver propelled space ship reaction mass. Regolith processing would be done at L5 construction shacks. These modular construction shacks would be launched from Earth, assembled in LEO and propelled with arc-jets to L5. The space colony would come next and 10,000 workers would be transported from Earth to do the work of SPS construction. Solar Power Satellites built at L5 would be moved down to GEO to sell power and start accruing profits.

The Moon plays a much more complex role in our vision. We will include tourism, astronomy and scientific research, SETI, asteroid mining, asteroid deflection and materials for ships to Mars and other destinations in the solar system. Moon mining will not be limited to simple open pit mining of regolith. Mining bases will be located on mare coasts where aluminum and calcium rich highland regolith as well as basaltic iron, magnesium and titanium rich mare regolith can be accessed.

There will be polar ice mining camps, KREEP mining in the Imbrium rim, mining of pyroclastic glass for native glass and elements that can be extracted from the surfaces of glass particles more easily than by extraction from complex minerals, and possibly even drilling for volcanic gases. Mining of vast areas of the mare for solar wind implanted volatiles including normal helium 4 and possibly helium 3 that are not likely to be found in polar ices of cometary origin - these all feature prominently in our vision.

Numerous mining bases will be linked by dirt roads and railways to mass driver sites and a circumlunar power grid will emerge for 24/7 power. All materials, or at least the 99.5%, needed for bootstrapping of lunar industry, creation of construction shacks and space tugs, and for SPSs will come from the Moon and possibly from the asteroids as well.

We are not certain about launching materials and finished products to L5. It might be possible to launch to L2 mass catchers and then haul cargos down to GEO or even launch directly to GEO. It might also be more plausible to launch to LLO (low lunar orbit) and collect the payloads, and then haul them down to GEO.

It is probable that L5 will not be very important and that construction shacks will all be located in GEO and that these will be mostly robotic.

While the nearly three second lag time that exists for teleoperation of robots on the Moon will hamper robotic operations on the Moon but not prohibit them entirely, the fraction of

MMM Theme Issues: The Lunar Economy - Years 1-25 Dec 1986 - Nov 2011

a second lag time for teleoperation of robots in GEO will not be a significant barrier to robotic construction in space.

Transportation System

Earlier it was thought that the space shuttle or a space shuttle-derived vehicle would launch cheap and that LH₂/LOX fueled rockets would be used to propel cargoes from LEO to the Moon. Our view is quite a bit different. Launch costs are high, even with Falcon rockets that offer the lowest price to LEO at present.

- We propose the use of **electric drives** to move cargoes from LEO to an L1 space station economically. Propellant masses for electric drives will be only a fraction of the mass of the cargo. Chemically propelled rockets would require propellants that amass several times the cargo mass and subsequently the cost of launching this extra mass to LEO would be several times higher than with electric drives.
- At the **L1 station** space storable water from lunar polar ice would be converted to LH₂ and LOX for landers. The first payloads would consist of solar panels, digging machines, regolith refining equipment and fueling systems for aluminum and liquid oxygen powered reusable landers.
- **Lunar fuels** must come on-line early to eliminate the cost of launching propellants for landers from Earth's surface to LEO.

Bootstrapping and ISRU [In Situ (Latin for "on site") Resource Utilization]

We will not ship a complete mining system to the Moon and then focus on space construction. To reduce supported⁴ mass and costs, we will land an industrial seed that will include manned habitat to bootstrap up industry on the Moon.

We will start out with small mining machines and build bigger ones. We will even build the mass driver or drivers on the Moon. We will mine at **multiple sites** (poles, mare coast, pyroclastic glass fields, KREEP terrains, crater central peaks, lava tubes, perhaps even drilling near volcanic domes) to get all necessary materials and link the mining sites with railroads to the mass driver sites.

Several years, perhaps decades, of work will be needed to build up industry on the Moon to the point at which SPS construction can begin. Long-term bonds will have to be sold to finance this project along with support from international governments.

The bootstrapping and ISRU concept will be applied to the SPS construction shacks too. We will launch the "bare bones" for these stations from Earth and enlarge them with metals and finished products from the Moon until we have the space infrastructure needed to build SPS. The construction shacks will be located in GEO. Lunar mass drivers will launch materials into space and mass catchers will haul those materials to GEO instead of L5. The GEO construction shacks will house only enough humans to supervise the robots that are teleoperated by Earthside crews with only a fraction of a second lag time for radio waves to travel from Earth to GEO and back.

More Brains Equals Less Payload and Lower Costs

The construction of lunar industry and SPSs will require a lot of planning and intelligence to figure out just how to do; But physically, it will involve no more time, energy, robot labor and manpower than building a giant space colony for 10,000 people would!! Why build that space colony when we need more infrastructure on the Moon and 90%+ work in space can be done with teleoperated robots and ground crews around the world connected by the internet???

We need more than just a single strip mine in the mare. While the **mare** can supply plenty of iron, titanium, magnesium, silicon and oxygen and lesser amounts of aluminum and calcium, the **highlands** can supply more vital aluminum and even cement produced by roasting highland soil in solar furnaces. There are highland areas where the regolith is 98% anorthite and this would be ideal feedstock for aluminum, calcium, silicon and oxygen production.

MMM Theme Issues: The Lunar Economy - Years 1-25 Dec 1986 - Nov 2011

Calcium might become the conductor of choice since it is a better conductor than copper and highland soil is richer in this metal than mare soil. Calcium metallurgy and manufacturing for out-vac cables and perhaps even mass driver coils must be developed. So the coasts become attractive.

There might even be blasting into hard rock with magnesium/LOX-based explosives if we find rock out-crops rich with industrial metals. The Imbrium coast is attractive because it contains lots of KREEP that can supply rare earth elements, potassium, phosphorus, thorium and uranium.

The Aristarchus pyroclastic glass fields that could supply nickel, copper, zinc, gallium, chlorine and other elements and the Marius Hills beneath which there might be chambers of volcanic gas evoke curiosity. Crater central peaks have never been sampled. Could they contain heavier elements thrust up from the mantle? I have speculated that since chromite is found in mare regolith, and this heavy mineral sinks in lava to form thin layers like those of the Bushveld igneous complex in South Africa, there might be layers of chromite deep beneath the mare that have been thrust up in some crater central peaks. If so, this would be quite a find, since chromite is a source of the vital industrial metal chromium.

The best mining sites and the best mass driver sites might not match so it will be necessary to build a **system of roads and railways** to link them. While it has been stated that mineral processing would be best done in space where solar energy is constantly available, a system of cables and solar power plants at the limbs of the Moon could supply energy to mining and mass driver bases constantly and when we are looking at things on this scale it should not be impractical to build a lunar power grid. It's also possible that a lunar power beaming system might prove to be superior to GEO powersats. The major obstacle here is not the construction of vast solar power farms at the limbs of the Moon for LPS but the construction of transmitting dishes miles in diameter. Perhaps large farms of small phased array dishes could do the job of transmitting microwaves 240,000 miles to reasonably sized rectennas on Earth but I am no expert when it comes to this so I might be way off target.

Choosing the machines for the lunar industrial seed, designing them and building them will require years of careful consideration and a small army of engineers, but there is no fundamental scientific or philosophical reason that this cannot be done. Three dimensional printers guided by computers that can crank out parts made of basalt, glass and metals could be at the heart of the bootstrapping lunar industrial seed. Robots will be key to assembly work.

Metal casting seems likely, but we will rely on cold working like forging and extruding as much as is possible. A manned presence will also be essential. Skilled human workers are the ultimate multipurpose robots. Humans might need biological sustenance, rest and recreation, but we are very versatile. Robots tend to be better and rapid repetitive jobs where high accuracy and reliability are required. **DD**

Footnotes & comments by editor:

1 The (Lunar) Industrial Seed:

"Defining the Lunar Industrial Seed", Part 1, D. Dietzler, MMM #229 October 2009

"The Lunar Industrial Seed", Parts 2, 3A, D. Dietzler, MMM #230, November 2010

Note: these issues of MMM are only available by member username and password from

<http://www.moonsociety.org/members/mmm/>

However much of this material is also available from

<http://groups.google.com/group/international-lunar-research-park?pli=1>

Also check out these Google Dox files

https://docs.google.com/document/edit?id=1n3OXV0zYqfMCNCj4Znaqf3lVw8s_0u7ChuGwMXKdZQ&hl=en#

2 The High Frontier by Gerard O'Neill,

an Apogee Books Publication: "In the mid-1970's the late physics Professor Gerard K. O'Neill published his book High Frontier. In it he laid out a possible road map for human settlement."

<http://www.apogeospacebooks.com/Books/Highfrontier.html>

MMM Theme Issues: The Lunar Economy - Years 1-25 Dec 1986 - Nov 2011

3 O'Neill branded people who preferred living on a natural world to living inside constructed space settlements as "planetary chauvinists." He firmly believed that as few people as possible should be stationed on the godawful Moon, and then in short tours of duty only. To this day he has a strong following. For our critique of his space settlement concepts see: "Reinventing Space Oases"

http://www.moonsociety.org/publications/mmm_papers/reinv_so.htm

4 "upport, upported, upports" – shipping "up" Earth's steep gravity well. (and thus, "downports" as well DD

The new **Space Age Era of Human-Robonaut Synergy**

By Peter Kokh

Robotics has come a long way in the past six years! And the promise is becoming real. Robotic assist-ants can relieve humans of tasks that are dangerous, boring, tiring, repetitious, etc. And they do not need life support, rest, entertainment, or socializing. They will not only pave the way for humans, but work side-by-side with humans after crews arrive, with future settlers also.

Whether the word "robonaut" sticks, or becomes replaced with the earlier "droids" (short for androids) is immaterial. The evolution of humans and robots working together is now well underway. Robotic assistants can take care of chores that are boring, tedious, repetitious, and/or dangerous. They do not need food, rest, sports, relaxation, or entertainment. They do not require life-support in transit or on the job. They do not produce wastes that need to be treated and recycled.

As for R2, now aboard ISS, the coming year will see it undergoing tests to make sure the trip to the space station caused it no trouble. Astronauts aboard the station will have a chance to get used to R2 and learn to work with it/him. In time, both will become comfortable working together. We need to get to the point where we can trust robonauts as reliable helpmates. No one can predict how long that will take, as adjustments in the robonaut's capacities and abilities may be needed. In the real world, needs emerge which might not have been foreseen.

One big challenge for NASA engineers has been to retrofit all of the robot's electronics to withstand radiation in space. They also worked to make Robonaut 2 as "smart" as possible. R2 has some 38 Power PC processors, including 36 embedded ones. The embedded chips are running in the machine's joints: its hands, shoulders, waist, elbows, neck and five large joints in each arm.

NASA also plans on periodically upgrading R2, it will be attached to a pedestal on the space station and it will work in place. By year's end, one or two legs may be installed to allow R2 to move around the station. A single leg could be easily attached to the robotic arm outside the space station so it can assist astronauts during spacewalks. In time, R2 could relieve astronauts of EVA assignments. Unlike humans, robonauts will not have to go through time-consuming pre-breathing steps. EVAs are risky and tiring.

We can expect to see robonauts fully integrated into ISS crews, becoming comfortable and reliable as partners, with a significant increase in overall mission productivity. Meanwhile, we will probably see robonauts become common in upper income households (as in the Jetsons cartoon series.) The "humans vs. robots" debate will become a curiosity of history. Both sides will have won, and the future of space activities will unfold more quickly and at less expense.

Some science fiction scenarios foresee humans in danger of replacement. Some see "Borg-like" transformations of humans. We see robonauts becoming faithful and enabling companions to humans, a path that dogs have been down long ago. Robonauts will hasten and deepen the pioneer settlement of space frontiers. Science-fiction stories that do not include

MMM Theme Issues: The Lunar Economy - Years 1-25 Dec 1986 - Nov 2011

this partnership will become dated. We have lived to see the day when this brighter, more promising future was introduced! PK

MMM # 244 April 2011

Could the “Space Experience” Sector Open the Moon Faster, for Less?

Paying Working Tourists vs. Paid Astronauts?

By Peter Kokh

How we’ve done things up to now: who builds what

The cost of doing things in space is undeniably increased by the way hardware (rockets, for example) are contracted out with provisions that highly favor chosen contractors, by decisions motivated by political considerations of which state or Congressional District will be most benefited, and selection of winners prior to construction and competitive testing.

The switch to real competition between commercial companies should help to reduce costs and improve equipment by a substantial margin. The NASA–Contractor monopoly has had its chance and given us space transportation systems impossible to continue financing.

In the next few years we will see real competition between a variety of crew reentry vehicles and space planes. Some will be best for this use, others for that. And all will be significantly less expensive thanks to real competition.

Crews: the cost of training and support

The NASA Astronaut Corps is rightly held in very high esteem. There will always be some individuals with problems. That’s neither here nor there. But there has been significant criticism of the cost of the program.

An “excess of astronauts — and what they do with their non-flying time — costs the space program far more than money. Their influence throughout the agency contributes to a NASA culture that is artificially enthusiastic, overconfident, contemptuous of outside advice and excessively obedient to short-term goals (as defined by the pilots) — often at the price of sound engineering.”

www.usatoday.com/news/opinion/editorials/2003-07-30-oberg_x.htm

How much does such a system add to the cost of missions to the International Space Station? How much would it have added to now-cancelled Moon Missions? We don’t pretend to know.

But if we are going to switch to commercial providers of hardware, how about also switching to commercial suppliers of trained astronaut crews? We need both, commercial equipment and commercial crews to break out of the amazingly non-American paradigm of “socialized space,” which, as much as we are all proud of NASA, is what it is has been, from day one.

Beyond Commercial Crews

Providers of commercial crews must factor the cost of personnel training, and attrition into the price for their service. While this cost could prove to be a fraction of what it costs NASA to train astronauts and to maintain an oversized astronaut corps, it would seem that there is a way to do even better, in fact,

a way to zero out the cost of crew training and support, so that the cost of a mission reflects only the cost of purchasing competitive space transport systems, and tools and equipment that crews will need.

Zeroing out Crew Training and Service Costs

MMM Theme Issues: The Lunar Economy - Years 1-25 Dec 1986 - Nov 2011

We are all now familiar with the “Space Tourism Industry.” It began with Space Adventures arranging to bring Dennis Tito to the International Space Station. “Tito joined [Soyuz TM-32](#) on [April 28, 2001](#), spending 7 days, 22 hours, 4 minutes in space and orbiting Earth 128 times.[8] Tito performed several scientific experiments in orbit that he said would be useful for his company and business. Tito paid a reported \$20 million for his trip.”

http://en.wikipedia.org/wiki/Dennis_Tito

Tito paid for his training as part of the price for his ticket, and also was required to make himself useful while onboard ISS, and all space “tourists” to ISS since have done likewise.

The “Space Experience Industry”

Right now, we are approaching the dawn of commercial flights to the edge of space. Perhaps it is time to junk the term “Space Tourism” in favor of “Space Experience.” The future of the Space Experience Industry seems to us unlimited. Thanks to John Spencer, the president of The Space Tourism Society, for this term!

Now in the near future where the focus will first be on prolonged zero-g flights to the edge of space, then orbital flights, finally commercial space hotels and resorts, we will be talking primarily about people on “the vacation of a lifetime.” They will do this to enjoy, not to work! Yet crews and staff catering to their needs will also benefit. While flight crews will most certainly be paid as these will be steady occupations, some “staff” – for space hotels, for example – could be paying volunteers, paying a bit less than tourists, for the privilege of staying in space longer, in trade for working assignments.

The pay-to-work Paradigm already exists

For some time now, individuals have volunteered, and some even paid, for the privilege of participating in archeological and paleontological “digs.” Something quite similar is common on “Windjammer Cruises” where tourist crews man the sails and do other jobs – everyone works, and they do so with enthusiasm for the privilege of a vacation experience otherwise out of reach.

Paying to work in Space

Now most of us need to “get paid” for work, and are hardly in a position to “pay for the privilege of working.” But make no mistake. Those who pay to work do get paid! Their pay is an unforgettable experience! Yes, of course, this is an option available only to those with enough income or resources to pay for the privilege. That this is not an option open to most of us is quite irrelevant. The point is that there is a population class growing in size that has begun fueling a “pay-to-work” sector of the economy that is growing year by year.

Fast forward a bit: we foresee the emergence of commercial companies that supply personnel who have paid for their own training, and who are ready to pay for the privilege of using that training on actual assignments – in space. Some will staff budget space hotels and resorts. And beyond that?

Space Adventures’1st Private Moon Expedition

“Make history as the world’s first private lunar explorer.

“Witness Earth rise as you emerge from the far side of the moon.

“Become a catalyst for humankind’s expansion into space.”

“Space Adventures invites you to join us for the most significant private expedition of our time – launching the first private mission to circumnavigate the moon.”

MMM Theme Issues: The Lunar Economy - Years 1-25 Dec 1986 - Nov 2011

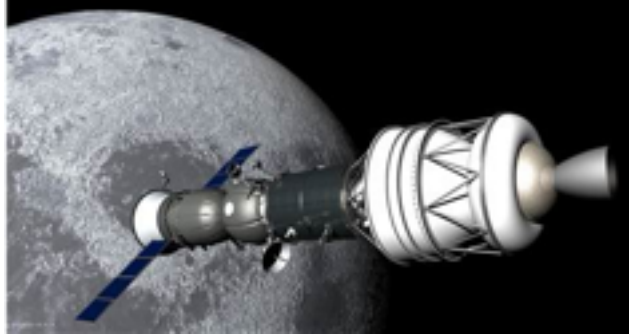

Space Adventures, working with Russian providers of the vehicle and service module needed, have already signed up one of the two tourists, who, with a Russian astronaut pilot, will make the first commercial Apollo 13 type loop-the-Moon trip. (Apollo 8 made several orbits about the Moon before returning.) A second customer is said to be ready to sign. **Watch this Space Adventures Video:**

http://www.spaceadventures.com/videos/LunarMission_no_ZG_msg_300kbps_480x270.mov

This flight could occur within the next to years, and will be the first presence of humans near the Moon in forty years, many years before any national space agency.

What next for the Space Experience Industry?

Once this flight is history, or perhaps even before out of anticipation, there will be a growing interest and demand among “experience-seekers” willing to pay the price for lunar landing excursions. Now there will be no on site facilities to cater to them. So what would be the cheapest way to provide such facilities? You got it! The ideal site for an ever-growing tourist complex having been identified in advance, the first paying experience seekers will plot out the site, photograph the site in detail and do additional investigation to supply architects on Earth with the information they need to draw up plans for the first structures, and a game plan for additional expansion. Perhaps this first crew could also leave a robonaut behind to be telepresence-operated by persons back on Earth to continue making site improvements in advance of the arrival of a second private crew again paying not only for their own training, but for the privilege of working on arrival at the selected site.

For an ideal site location idea, read “An ‘All-in-One’ Moon Resort” pp. 82–85, **MMM Classic Themes – Lunar Tourism**, a free download at:

http://www.moonsociety.org/publications/mmm_themes/mmmt_tourism.pdf

Because “pay for the experience” tourists will be taking on serious work assignments, and have even paid for the training to allow them to do so, their tickets to the Moon (resort) will be cheaper than those of purely passive tourists. Those willing and able will pay-to-prepare, pay-to-build, pay-to-explore, pay-to-prospect, and pay-to-deliver services.

Yes, these people will come from the wealthy, as few of the rest of us will be able to compete for these positions. But the point is that in this manner, lunar surface facilities including not just tourist resorts but science outposts, even initial factories, will get built sooner and at far less taxpayer expense (translate that to freedom from political veto power).

As we have suggested, pay-for-experience tourists will be accompanied by and work with robonauts who will do the boring, repetitive, and dangerous tasks. They need no life support, no rest or recreation, and no need to return to Earth. They also require less room aboard the craft that bring pay-to-work tourists to the Moon. Thus robonauts promise to greatly multiply the cost-effectiveness of this approach, and bring down all costs even more. So we can add to the “pay-to” list, pay to teleoperate, and pay to maintain equipment.

This scheme can serve to expand science on the Moon as well as tourism. “Pay-to” personnel can also go to the Moon for the privilege of collecting specimens, of prospecting, and doing all sorts of scientific research. The can also pay for the privilege of testing equipment to turn moondust into usable materials – “ISRU” – “in situ” [on location for those of you not

MMM Theme Issues: The Lunar Economy - Years 1-25 Dec 1986 - Nov 2011

familiar with Latin] resource utilization. Thus people may “pay-to” develop building materials with which to expand habitat and outpost complexes with far less “upports” from Earth.

We do not pretend that this scenario is certain to develop. The World Economy is too near implosion, and that could put off all plans, commercial as well as tax-supported inefficient government programs.

Wikipedia “**Extreme tourism or shock tourism** is a type of niche tourism involving travel to dangerous places (mountains, jungles, deserts, caves, etc.) or participation in dangerous events. Extreme tourism overlaps with extreme sport. The two share the main attraction, “adrenaline rush” caused by an element of risk,” http://en.wikipedia.org/wiki/Extreme_tourism

Yes, there will be space tourists in the traditional sense who want to just enjoy and sightsee and they will pay even more to go into space. But here we talk about those who will pave the way and create places for others to visit. Here we talk about space tourists willing to pay for own training, pay their own insurance etc.; who pay (rather than get paid) for work and assignments.

How do we cover cost of equipment, vehicles, etc.? A first answer would be the commercial companies and consortia who want to operate lunar resorts, and deploy factories on the Moon, mining operations etc. Keep in mind that this is an introductory article aimed at getting further brainstorming in high gear. We offer this article as a contribution to a **Commercial Model for settling the Moon.**

Addenda: Opening the Moon to the less-well-to-do

The overwhelming majority of us would never have the resources to participate in such scenarios. But there could be **lotteries**, with drawings held when the total entry fees exceed costs to be covered. Winners who did not pass medical and other tests, could sell their rights to the highest bidder. There could also be limits on those who could enter, to minimize such situations.

When Weight is an Issue

We have not discussed the simple hard fact that transporting anywhere in space those who are bigger and heavier goes up in proportion. Should otherwise capable midgets, dwarfs, and just smaller individuals pay less? For passage perhaps, but maybe not for training.

We hope you enjoyed this article and that it sets off a chain of constructive brainstorming. See you on the Moon! (I wish!)

PK

MMM # 246 June 2011

Could Some Lunar Lavatubes Be Hiding Valuable Resources? Let’s Speculate!

By Peter Kokh with input from David Dunlop

Forward [Reprint of an article in MMM #44, April 1991]

For centuries we’ve realized that the Moon’s surface was desert-dry. The first good telescopes had shown the great dark areas hopefully called “Seas” to be really dry low-lying plains (filled with a dry quicksand of dust, many wrongfully supposed). We took it for granted that the Moon had formed wet, as had Earth, and that its low gravity was insufficient to hold on to its aboriginal atmosphere so that its waters had been lost to evaporation and ultraviolet disassociation.

The findings of the Apollo missions and follow-up studies of their precious hoard of Lunar Samples told another story. The maria seas were really great sheets of frozen lava with

MMM Theme Issues: The Lunar Economy - Years 1-25 Dec 1986 - Nov 2011

the upper few meters pulverized and gardenized into a dust blanket (the regolith, a feature shared with highland areas). Moreover, nowhere was there to be found any relics or clues of a past wetter epoch. There is no rusted iron. In fact, even with a gross composition of 42–45% oxygen, the Moon seems under-oxidized. For what iron there is, is either FeO, ferrous oxide (a less oxidized state than our commonplace Fe₂O₃), or pure iron fines. Nor are there any hydrated minerals or clays, so common on Earth. The Moon had apparently formed hot and dry, quite unlike the Earth, perhaps from vaporized material cast off (but retained in orbit) following a major collision between the forming proto-Earth and a smaller but rival body forming at roughly the same distance from the Sun. One day we may know the 'rest of the story' but this is our current best solution to the puzzle.

What we have found instead, quite by surprise, is a non-negligible endowment of hydrogen atoms (1 ton in a football field sized area 1 yard deep – far less than in Earth's driest desert sands) adsorbed to the fine particles of the regolith 'top soil', apparently a gift of the Solar Wind which has been softly buffeting the Moon's surface for billions of years.

[skipped paragraphs irrelevant to argument]

Yet it has occurred to the writers that there is some possibility, indeed an appreciable chance that vaporized cometary materials have been cold-trapped in places not exposed to the loss mechanisms of cosmic radiation and solar wind gusts. The greatest wave of comet bombardment of the Moon may have been in the formative era. But even in the past 3 plus billion years since the great impact basins were filled with runny lava, an appreciable number of comets (in episodic waves or not) may have impacted the Moon.

The maria are not totally flat, but have a slow gradient, stepped by lava flow fronts, with highest elevations near the source(s) of the magma upwellings. It is in these relatively higher regions of the mare seas that we expect to find lava tubes. Very near-surface [and especially large] lava tubes would have collapsed, and it is probably their relics we see in the many sinuous rilles (like Hadley, visited by Apollo 15). And we see winding 'rows' of rimless sinkholes, which would seem to indicate partially intact tubes a bit deeper below the surface. Here and there, a stray comet might have hit the jackpot, crashing through the roof of a lava tube and vaporizing. While perhaps most of the vaporized material would have escaped out of the impact crater, it is possible some fraction fleetingly pressurized the adjacent segments of the lava tube (too much pressure would only blow out the roof) long enough to freeze out as frost on its floor, ceiling, and walls, at a distance where they wouldn't have been heated by the thermal shock of the impact. Down here, there is no exposure to cosmic rays or errant wisps of solar wind. We may have won the Solar 'Lottery'!

[skipped paragraphs irrelevant to argument]

The technical feasibility of deep-looking radar is quite real. Improvements on the radar that have revealed ancient river bottoms beneath dry Sahara sands, may someday reveal the existence and whereabouts of many near surface lava tubes in the lunar basalt seas. In our earlier article "Lava Tubes" in MMM # 25 APR 1988, we stated our belief that deeper lava tubes may lie in subsequently buried early lava sheets. Many of these may have been later filled and plugged, but some few could remain void. But whatever the case, only near surface tubes could have been entrusted with this gift of the comets. Will such improved deep-looking radar find a few unmistakably ice-walled lava tubes as well as the more common bone-dry ones?

If so, will the frost layers be so diffused and thinned out on the inner surfaces of these voluminous hollow sanctuaries that, scientific treasure trove or not, they won't be economically recoverable? That's a possibility. The history of space development scenarios and speculations has been heavy on overly romantic expectations. Despite the dashing of many naive hopes, from hydrated minerals on the Moon, to lichen covered fields on Mars, the promise of a human-settled inner solar system rooted in the use of extraterrestrial materials, spring-boarding from Earth's ever growing energy thirst, is still concrete enough to keep us planning ways to work with the grain of nature off planet.

MMM Theme Issues: The Lunar Economy - Years 1-25 Dec 1986 - Nov 2011

Ice encrusted cavernous tubes on the Moon may or may not be found. But if we don't find any, it will be a matter of bad breaks only. Until we've checked our ticket stub, we can't dismiss the not-so-unfavorable odds that we've won this Solar Lottery! < MMM >

Twenty Years Later – Revisiting the Question Lavatube Ice Reserves?

Most of us, I suspect, imagine these underground lairs to be nothing but barren, and somewhat boring caverns whose main value is their capacity to shelter extensive human settlements and all the activities that go with it.

Two decades ago, I wondered aloud (in MMM #44 bulk of text reprinted above) if it might just be possible, however low the odds, that a comet small enough not to obliterate a tube, but large enough to penetrate its ceiling with a precise hit, against very high odds, and vaporize with the cometary ices freezing out on the tube's inner surfaces, waiting hundreds of millions of years for some intelligent explorer-settler to discover this treasure. I dubbed such a comet strike "winning the cosmic jackpot."

But now we know that objects, probably small astrochunks rather than comets (but who can be sure?) have penetrated lavatube ceilings in several places on the Moon. And it occurred to me, that even if none of these penetrators was cometary in nature, the very presence of an opening might invite cometary vapors from a nearby strike to wander in, and take up abode. After all, this is how much if not most of the ice deposits in permanently polar craters slowly built up. Comets can strike anywhere at anytime, The sun and the solar wind will work to blow those gases away from the Moon. But if a comet strikes on a part of the Moon experiencing nightspan, and some of the vapors spread to the polar regions before the Sun rises, they are sequestered in these polar cold traps.

Now Chandrayaan-1 and Lunar Reconnaissance Orbiter data both show intact lava tube sections that open onto rilles, the collapsed remnants of once extensive tube sections. These entrances could also be penetrated by cometary vapours.

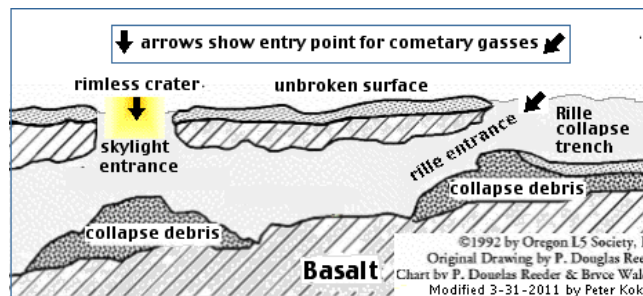

NOTE: The age of skylight collapse pits could be considerably younger than most rille collapses, thus skylight cometary volatile sequestration should be much less rich on the average than rilleside tube entrances. The former are easier to find at low-res, the latter requiring high-res for confirmation and even for original notice.

But there is a catch to this idea. When it first occurred to me, 20-some years ago the "word" was that we expected the temperatures inside intact lunar lavatubes to be on the order of 80° K, -193° C, -315° F. **But that may not be the case.** There is good reason to believe that lavatubes should be of a temperature that we would expect at that depth below the lunar surface.

Now during the Apollo missions. We probed the surface to a depth of 2 meters, not far, but far enough to suggest that at that depth, the temperature was fairly stable no matter whether the surface above was experiencing full dayspan heat or bone-cracking nightspan cold. While we did not really probe deeper, other evidence suggests that as we go down deeper, we should reach a point at which residual heat from the lunar interior balances any neat heat loss to space over the dayspan-nightspan cycle.

MMM Theme Issues: The Lunar Economy - Years 1-25 Dec 1986 - Nov 2011

Polar craters are different. They are permanently exposed to the heat sink of cosmic space at a few degrees above absolute zero. Lavatubes are not so exposed, so they will not have cooled down below the temperature prevailing in the surrounding rock

I put the question to **Dr. Alan Binder**, Principal Investigator for the **Lunar Prospector** mission 1998–9, and received the following prompt reply:

“As I state in [my novel] **MOONQUAKE** (p 170), the temp at 1 meter depth in the regolith is (in the equatorial regions – it will be somewhat colder at high latitudes) -20°C , is essentially constant, and the gradient in the regolith is 1 to $1.5^{\circ}\text{C}/\text{meter}$ via Apollo measurements. Thus at the bottom of a typical 3–5 m deep mare regolith layer the temp is about -15°C .

“Now, the Apollo conductivity measurements were made in the outer couple of meters of the regolith, i.e., not even to the bottom of the regolith, but, we know from the passive seismic measurements that show that the P-wave velocity of successively deeper layer increases dramatically as a result of the decrease in brecciation of the mare basalts with depth. Thus, the thermal conductivity must increase and the thermal gradient will decrease with increasing depth.

“But right now, we do not know how much. Clearly, the deeper a lava tube is, the hotter it will be --- but right now we have no good data to tell us the gradient. Lets say a tube were 100 meters deep and the gradient is $0.1^{\circ}\text{C}/\text{meter}$, the tube temp would be say $+5^{\circ}\text{C}$. But as you can see, until we know the latitudes' depths and the temperature gradients as a function of depth, this is just a game of rough estimates.”

This argument explodes the previously heard expectation that Lavatubes would be cryo-environments, cold enough to preserve refrozen cometary ices indefinitely.

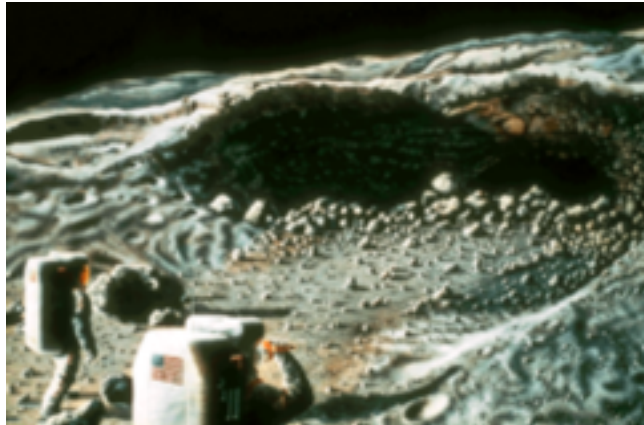

The classic Pat Rawlings painting above shows astronauts gazing at such an entrance, which as collapsed rubble or talus, will be challenging to traverse in order to get inside. Now we know that they won't need ice-picks or ice skates!

Oh how reality has a way of dashing one's favorite expectations. If cometary ice were available at lavatubes far from the Moon's poles, the prospects for early settlement in those areas would have been much brighter.

As usual, simpler understandings give rise to expectations that are dashed by more complete knowledge.

What about volcanic gasses?

We now know, or suspect, that lunar volcanism may have been far wetter than previously expected, that the Moon did not form “bone dry.” So in lavatubes that remained plugged at both ends, could there be trapped volcanic gasses of economic value? Sulfur, carbon, nitrogen, and hydrogen oxides? In a world where the key elements of organic chemistry are extremely scarce, such underground reservoirs or gas traps could be game changers.

MMM Theme Issues: The Lunar Economy - Years 1-25 Dec 1986 - Nov 2011

Now to be fair, we can't yet pinpoint the location of lavatubes that are wholly intact, only those that have been compromised by skylight collapse pits or rille collapses. But even in these tubes open to the outside vacuum, if there had been some volcanic gasses, there might be residual traces left that could be detected and analyzed by sophisticated equipment.

This is certainly more than just an interesting question, it is one of potential great economic significance. On the downside, the surrounding basalt is likely fractured, allowing some slow seepage of such volcanic gasses to the surface to be blown away by the solar wind. But in cases where seepage has been at a minimum, what kind of pressure (and desitiy) might we expect? Could some such deposits be of economic significance? We will never know if we never probe further.

Volcanic gases on Earth:

The principal components of volcanic gases are water vapor (H₂O), carbon dioxide (CO₂), sulfur either as sulfur dioxide (SO₂) (high-temperature volcanic gases) or hydrogen sulfide (H₂S) (low-temperature volcanic gases), nitrogen, argon, helium, neon, methane, carbon monoxide and hydrogen. Other compounds detected in volcanic gases are oxygen (meteoric), hydrogen chloride, hydrogen fluoride, hydrogen bromide, nitrogen oxide (NO_x), sulfur hexafluoride, carbonyl sulfide, and organic compounds. Exotic trace compounds include methylmercury, halocarbons (including CFCs), and halogen oxide radicals.

The abundance of gases varies considerably from volcano to volcano. However, water vapor is consistently the most common volcanic gas, normally comprising more than 60% of total emissions. Carbon dioxide typically accounts for 10 to 40% of emissions.

http://en.wikipedia.org/wiki/Volcanic_gas

Now until recently, the prevailing dry-Moon hypo-thesis strongly suggested that there would be no water, water vapor, or hydrogen in lunar volcanic gas. But given the findings of Chandrayaan-1 and other recent probes, this expectation has turned on its head. But without any experimental evidence we have no idea how "humid" lunar volcanic gases may be.

Instead of turning its back on the Moon, one would think that the agency would be working diligently on a mission to probe the Marius Hills area of Oceanus Procellarum, the "Ocean of Storms" where there is much evidence of past volcanic activity, a number of suspiciously volcanic "domes", and a confirmed lavatube skylight!

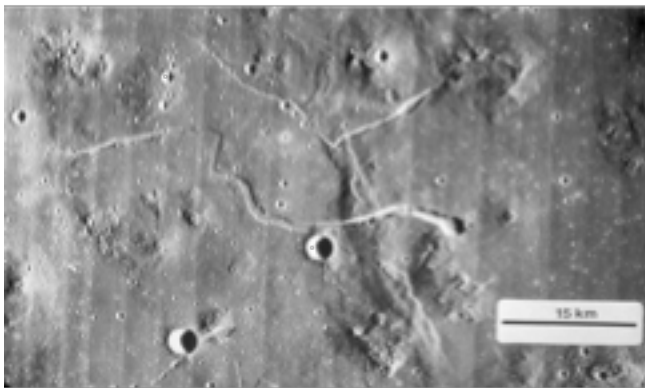

Left: A section of the Marius Hills: rilles, domes, etc.

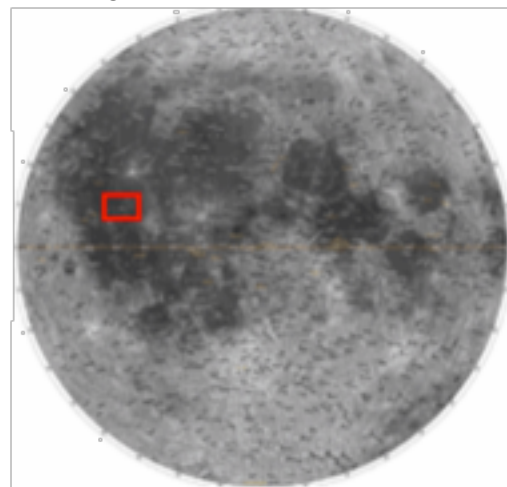

Right: Location of the Marius Hills

MMM Theme Issues: The Lunar Economy - Years 1-25 Dec 1986 - Nov 2011

Kaguya lavatube Skylight, Marius Hills below

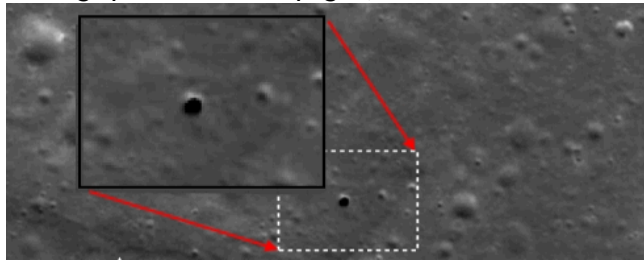

What are people in Washington thinking? But we already know that the political process is rarely moved by reason. Rather by “how many jobs will it bring to my district?” or “How will this help my re-election chances?”

What’s at Stake

At present, these are just interesting questions, and it is frustrating, that even if the Obama Administration had not altered NASA’s course, that the agency had no specific plans, at least none announced or even proposed in the public domain, to begin any kind of lavatube exploration. Why? NASA is driven by scientists rather than by potential settlers, and a determination of resources of economic value to settlers is of little interest to many if not most of them. This is a case of impatient shortsightedness, as there will be far more science done on the Moon if it is settled, by the settler population, than will ever be done by scientists from Earth, returning to Earth, laying no foundations., only interested in publishing arcane papers.

The Good News

There is a trade-off and something in our favor. If Lavatubes were truly cryogenic environments, heating settlements and factories and agricultural areas within would be a major challenge. That they are nonetheless below room temperature is also good. All human and industrial activities create heat, and if these tubes were any closer to room temperature, we would have a major problem in shedding excess heat.

So while we may not find much ice, if any within these voluminous “Hidden Valleys” and maybe precious little in the way of volcanic gases (we expect this to vary widely from tube to tube so it’s definitely worth exploring them all) we are still blessed with a world well-endowed with these spacious pre-shielded environments that will make “settling in” on the Moon in a major way much more feasible. Again, it is the nearside maria, not the poles, where the bulk of Lunans will live and work. PK

MMM # 247 August 2011

Moon Mining Machines: A Materials Challenge

By David Dietzler

Editor: Dave submits this article with a note:

“I hope it gets the point across to the reader that we need to start looking at things built for the Moon and on the Moon of lunar mats rather than continuing to design ultra-light aerospace grade payloads that are rocketed to the Moon.”

I have the utmost respect for Matthew E. Gajda, his associates at the University of Wisconsin, and their Mark 3 lunar volatiles miner designs. See:

<http://fti.neep.wisc.edu/pdf/fdm1304.pdf>

I have no doubt that this will evolve into even better machines in the future. We really have no other design for a Moon mining machine to base any projections on. However, the

MMM Theme Issues: The Lunar Economy - Years 1-25 Dec 1986 - Nov 2011

design relies on materials like Ti-6Al-4V, Ti-6Al-6V-2Sn, Molybdenum alloy, stain-less steel and carbon-carbon that are not to be had on the Moon. In the future, we need to see designs for vehicles, mining machines, even trains based on lunar available materials. Tin, vanadium, zirconium, and molybdenum are not available on the Moon unless we rocket them in at great cost. Chromium and manganese are present in regolith but not in large concentrations. Carbon in the form of solar wind implanted volatiles and possibly from polar ices will be needed mostly for life support systems and what little there is for Indus-trial uses will be needed for tool steels, electric motor winding insulation and silicone lubricants.

The lunan engineers will have to figure out how to build things from straight titanium, titanium-aluminum alloys and titanium aluminides. There will be plain aluminum, aluminum-silicon alloys, and aluminum alloys with various amounts of magnesium, manganese and chromium. Magnesium can be alloyed with lunar aluminum, silicon, manganese and possibly thorium. These aren't the best alloys but they will have to do. Nickel might turn out to be the lunan engineers' savior. Carbon free **maraging steels** can be made by alloying iron with 18 to 25% nickel.

http://en.wikipedia.org/wiki/Maraging_steel

There is very little nickel in regolith, but it is easy to extract. Meteoric particles containing 5% to 10% nickel are present in regolith at concentrations of a few tenths of a percent. These can be magnetically extracted by harvesters that process millions of tons of regolith every year. The nickel can be separated from the meteoric iron with carbon monoxide gas or by electrodynamic devices similar to mass spectrometers. There won't be much cobalt, niobium or molybdenum for maraging steels but there should be plenty of titanium and some chromium to alloy them with.

At www.makeitfrom.com/data/?material=Maraging_Steel we read, "C-type grades contain cobalt, which is the main strengthening agent in the alloy. T-type grades contain no cobalt, and use titanium in the same role. Despite significant differences in composition, mechanical properties do not vary significantly between the two types:

- (1) Used in rocket parts, recoil springs, landing gear components, high-performance machine parts (including shafts, gears, and fasteners), and
- (2) In extrusion and casting tooling."

Vacuum welding will be a problem that Lunan engineers will have to deal with. This can be prevented by making metal parts that come in contact out of dissimilar metals with different microcrystalline structures. So we might see titanium gears bolted in with maraging steel bolts and combinations of intermeshing maraging steel and titanium gears. Solid lubricants can also prevent vacuum welding, but molybdenum and tungsten for sulfide solid lubricants are lacking on the Moon. We might make do with cheap iron sulfide.

Pure iron might be used for low stress applications but otherwise won't have much use in machinery. Iron-aluminides are very strong and corrosion resistant but lack ductility. Magnesium might be used for reflectors and low stress applications that demand low weight. Glass fibers, glass cloth, and glass-glass composites might find uses (e.g. farings, coverings). Basalt might be used for its high abrasion resistance. Tubes that convey regolith and basalt coatings on mining buckets come to mind. Basalt is very hard but brittle. A basalt-coated bucket handling powdery moon dust should be okay unless it hits a rock and cracks.

Many terrestrial exotic alloys are made for high strength and lightweight for aircraft applications. This won't be so important on the Moon when it comes to ground vehicles and mining machines. Earthly alloys are also made for high temperature operation in jet engines and internal combustion engines. There won't be many combustion engines on the Moon, with the exception of Moon made rockets. Mining machines will use electric motors cooled with sulfur dioxide gas perhaps and the highest temperatures they will encounter will be about 250 F. during the lunar day.

MMM Theme Issues: The Lunar Economy - Years 1-25 Dec 1986 - Nov 2011

Corrosion resistance won't be that important on the airless, dry, salt water free Moon. Exceptions to the above statements will be volatiles miners that have to heat regolith up to 700 C. to unleash solar wind implanted light elements in the form of H₂O, CO, CO₂, CH₄, N₂ and He. If sulfur is to be extracted thermally, higher temperatures will be needed and the possibility of sulfuric acid formation arises. Iron and nickel aluminides might be used instead of stainless steel in volatiles miners.

Engineers determine the stress on parts in machinery and figure out how stout a part made of a given alloy must be. They will have to “beef up” parts made of any “second-best” alloys producible on the Moon. This would not be good for a machine that is to be rocketed up to the Moon because mass must be kept low; but for machines made on the Moon, weight won't be an issue. It might even help to make lunar machines more massive so they can get more traction in low lunar gravity.

Machinability, weldability, ductility and ease of forming are also factors that engineers consider when they select materials. We can only hope that Lunan manufacturing engineers are able to figure out how to work with lunar available materials.

Commercially pure titanium is said to be easily-formed. I am not a metallurgist or engineer, but I've heard repeated complaints from an engineer friend about the problems with welding Ti-6Al-4V in a vacuum. It seems the aluminum boils out of the alloy.

The bottom line is this: We can land 1,000 tons of cargo in the form of 100 Mark 3 or more advanced Mark 4 or Mark 5 miners at ten tons each – or we can land 1,000 tons of production machinery and boot-strap up factories for making as many volatiles miners, excavators, bulldozers, slushers, drag lines and other equipment that we want. If these Moon-made machines have to be twice as heavy using thicker parts made from weaker lunar materials instead of exotic alloys available on Earth – it just won't matter. The cost of rocket transport from Earth will always be higher than making things on the Moon once industrial infrastructure is built there, or so we reckon.

The umbilical cord to Mother Earth has to be cut. DD

Lunar Iron and Alloys of Iron

By Dave Dietzler
ALLOYS OF IRON

MMM Theme Issues: The Lunar Economy - Years 1-25 Dec 1986 - Nov 2011

Name	Composition	Properties	Uses
Ingot iron	Pure industrial grade	Ultimate tensile strength (UTS) 42-48,000 psi elongation (el) 22-28%	Structures, beams, plates
Iron whiskers	Single crystal	0.00004 in. diameter UTS up to 500,000 psi	Structures, electronic parts small powder metallurgy parts
Iron powder	C and S free	10 to 40 micron powder	Propellants,
Iron-silicon	4.5% Si	50-60,000 psi UTS el 8-22%	Structures, beams motors, transformers
Iron-nickel	47-55% Ni	UTS 70-90,000 psi el 30-50% nickel increases strength w/o loss of ductility	Structures, containers
Iron-titanium	Eutectic solutions	Increased hardness and strength	Structures, containers
Iron-manganese	1% Mn	UTS 60,000 psi, el 40% Mn increases strength and hardness	Structures, beams

Also of interest are iron-aluminides. These contain 10–30% Al by wt. and have excellent corrosion and oxidation resistance similar to stainless steel. They have also been under investigation for high temperature mechanical properties. At lunar day span temperature of 123 C. the Fe-Al alloy designated FAS (15.9% Al, 2.2% Cr, 0.01% B,) has a UTS of 109,000 psi with an elongation of 15% and a yield strength of 42,000 psi. [3]. Aluminum and chromium are present on the Moon. Boron is rare. Note that only 2.2% of this alloy consists of chromium, while stainless steels contain 10 to 25% Cr. This alloy is stronger than cast iron or cast titanium but lacks ductility and toughness.

In conclusion, it is evident that although the Moon is lacking in carbon for the production of steel making it practical to produce steel by the crucible or cementation process on the Moon only in small amounts when no other material can substitute (e.g. tooling), there are numerous iron alloys that can be produced with lunar available elements. Lunar industry will not rest on steel as does Earthly industry. It will rest on metals like aluminum, magnesium, titanium, iron and alloys of iron.

ALLOYS OF IRON

Also of interest are iron-aluminides. These contain 10–30% Al by wt. and have excellent corrosion and oxidation-resistance similar to stainless steel. They have also been under investigation for high temperature mechanical properties. At lunar day span temperature of 123 C. the Fe-Al alloy designated FAS (15.9% Al, 2.2% Cr, 0.01% B,) has a UTS of 109,000 psi with an elongation of 15% and a yield strength of 42,000 psi. [3]. Aluminum and chromium are present on the Moon. Boron is rare. Note that only 2.2% of this alloy consists of chromium, while stainless steels contain 10 to 25% Cr. This alloy is stronger than cast iron and cast titanium, but it lacks ductility and toughness.

In conclusion, it is evident that although the Moon is lacking in carbon for the production of steel making it practical to produce steel by the crucible or cementation process on the Moon only in small amounts when no other material can substitute (e.g. tooling), there are numerous iron alloys that can be produced with lunar available elements. Lunar industry will

MMM Theme Issues: The Lunar Economy - Years 1-25 Dec 1986 - Nov 2011

not rest on steel as does Earthly industry. It will rest on metals like aluminum, magnesium, titanium, iron and alloys of iron. DD

MMM # 248 September 2011

Ten Billion Dollars to Industrialize Space?

By Dave Dietzler

Where are we? What do we need?

Preceding a solar power satellite building enterprise we really need;

- 1) **Lower cost launchers** than those available today or in the near future
- 2) **Inflatable LEO hotels**
- 3) **Electrodynamic tether systems** to collect all that steel and aluminum junk in orbit that is estimated to be 1000 tons or more. Let's say that successful space tourism enterprises are doing things that prove they can do the job, what's next?

What if in the future, the dream of a reusable HLV that can orbit say 100 tons for \$10 million is realized? For \$8.7 billion, the amount of money to be made from the sale of electricity at ten cents per kilowatt hour in one year from a 10 GWe solar power satellite we could afford to launch massive amounts of cargo. Let's be more realistic and consider transmission losses and a slightly lower price for the electricity.

Let's expect \$5 billion. We could orbit 50,000 tons with RHLVs at the price stated above. It would be possible using NEP [Nuclear Electric Propulsion] or tethers and reusable Moon landers fueled with LUNOX and metal powders to put at least 30,000 tons on the Moon and in GEO where the construction shacks were located. In all likelihood, mostly robotic construction shacks will be located in GEO where the powersats will be finally located. Lunar mass drivers could launch to mass catchers at L2 that then haul payloads to construction shacks in GEO. If we could orbit 100 tons for \$100 million we could still get 5000 tons in LEO and 3000 tons on the Moon and in outer space and bootstrap industry.

Three thousand tons is still a lot of cargo Self replicating seeds of lower mass have been imagined. NASA's Advanced Automation for Space Missions study in 1980 estimated 100 tons for a self-replicating robotic seed on the Moon and there were no 3d printers even back then! Let's say we did have 3000 tons of robotic and manned equipment on the Moon and in space at L1 and GEO and then we crank out one hundred 100 MWe SPS and/or power relays and get it done within 20 years to pay off the bond holders. After that we make clear profit for continued reinvestment and expansion until growth becomes exponential and the Moon and Earth orbital space is highly industrialized. The next step is Mars, the solar system at large and then on to the stars!

One of the keys to success is to maximize the use of lunar materials. Lightweight electronics will be upported [shipped up the gravity well]. Massive unitary simple things will be made on the Moon. Regolith refining processes often require chemicals such as chlorine and fluorine. These would be recycled but there will be leakage and to expand the industrial SEED to build FACTORIES we will need more and more chemicals upported at high cost.

New Technology to the rescue

I favor Dr. Peter Schubert's Lunar Dust Roaster and All Isotope Separator, a device similar to a mass spectrometer but much larger because it doesn't need chemicals, just energy. However, part of the device is made of thorium oxide and thorium is present in KREEPy terranes at just 10ppm to 50ppm. Perhaps part of the device could be made of pure silica, alumina or

MMM Theme Issues: The Lunar Economy - Years 1-25 Dec 1986 - Nov 2011

titania with drilled passages and sulfur dioxide coolant since sulfur is available on the Moon.

At 53 tons for \$100 million with Falcon Heavy rockets we could get 2650 tons in LEO for \$5 billion and say 1500 tons on the Moon and in space. Of that 500 tons could be materials extraction equipment, 30 Genesis 1 modules for living and working would amass 45 tons, the rest would be mining and manufacturing machines, rocket landers and supplies like dehydrated food. Then we rocket Moon made parts to L2 mass catchers then to GEO and build up construction shacks and build mass drivers on the Moon.

Preplanning of a million details and a few million people with a zeal for outer space willing to invest several thousand dollars apiece in 20-year bonds would be required. We will need at least \$5 billion for the Falcon Heavy launches though we might get a modest discount for these 50 launches from Space-X, and we will need another \$5 billion for R&D, hardware (actual payload costs) operations and to foot the cost of transporting humans to the Moon; more about that later. If we can get a discount and launch Falcon Heavies for \$80 million a shot then we would spend \$4 billion to orbit payloads and have an extra billion dollars to invest in R&D, operations, hardware, etc. That discount could make a big difference. A billion dollars is nothing to sneeze at.

Zero coupon bonds pay nothing until the bond reaches maturity. If we offer these bonds to raise about \$10 billion with an interest rate of about 4.7% then after 20 years we'd need to pay back about \$25 billion. This means we need to have 10 GWe of capacity at work by year 15 earning \$5 billion a year so that we can gross \$25 billion in years 16-20. After that we make clear profits to reinvest and expand. Hopefully there will be massive tax breaks to encourage this business. We could start offering stocks and pay dividends and this might attract much more investment. We will continue to build space power systems in years 16-20 so that we will earn a large amount of money. We won't stop at 10GWe in year 15.

Of the 2650 tons in LEO for \$4 billion or \$5 billion we will devote 1500 tons to the previously stated purposes and locations and 1150 tons will be NEP tugs plus propellant or tether systems for travel from LEO to L1 or LLO in addition to propellant for the first automated landers that set up robotic fuel and LUNOX production for the reusable landers to haul cargo arriving at L1 or in LLO down to the lunar surface. Getting humans to the Moon would take a large bite out of things. To get those workers from LEO to L1 we'd need a lunar-fueled reusable ferry system. If tethers could toss a manned capsule to L1 or LLO with a retro system that would save a lot on upported LH2 and LOX or lunar metal powder fuels and LUNOX.

This 1150 tons could consist of 400 tons argon for NEP guessing propellant at about 15% of cargo mass and 250 tons for lander propellant preceding lunar propellant production.* The remaining 500 tons will be for the NEP tugs themselves, mass catchers, and an L1 refueling depot and powersat for lunar night power.* * Instead of NEP a 400 tons tether system would be pretty stout. Everything including upper stages would be cannibalized so we will have some scrap metal to get going. Even so, we'd really need to have 10GWe up by year 15 so we could sell \$25 billion worth of power to make good on those bonds, and that might be a real challenge.

Moon tickets for us humans

Human transport could run a billion dollars for 20 Falcon 9/Dragon flights with 7 men each over 20 years with 35 men doing 5 year stints, so we'd only have \$4 billion for R&D, actual hardware and operations, unless we get a discount. I guess the L1 depot and ultra-light powersat would be no more than 100 tons and the NEP tugs and mass catchers another 100 tons so let's estimate 300 tons for the initial construction shack in GEO.

The construction shack would then be built up with steel and aluminum scavenged from Earth orbit with electrodynamic tether spacecraft and parts rocketed up from the Moon. Once the shack was built up mass drivers will launch loads of regolith to L2 mass catchers that haul the material for building powersats. About 90% of the work will be done by teleoperated robots controlled by crews on Earth, in space and on the Moon.

How low can we go?

It might be possible to do the job with much less than 1500 tons on the Moon. For

MMM Theme Issues: The Lunar Economy - Years 1-25 Dec 1986 - Nov 2011

those who would like to read about the mere 443 ton seed that would grow into an over 300,000 ton factory for a self replicating starship, see:

<http://www.rfreitas.com/Astro/ReproJBISJuly1980.htm>

A Self-Reproducing Interstellar Probe www.rfreitas.com

HTML Editor: Robert J. Bradbury

*250 tons to land the fuel and LUNOX production equipment.... with 250 second Isp Al and LOX motors that's 2.45 kps exhaust V to land from L1 about 2.3 kps.....so $e^{(2.3/2.45)} = 2.557$

I said 250 tons of propellant so $(x+250)/x = 2.557$ $(x+250) = 2.557x$

$250 = 2.557x - x$ $250 = 1.557x$ $x = 160$

Thus we can land 160 tons of Al and LUNOX equipment plus landers.... with 250 tons of Al and LUNOX sent to L1.... if the landers amass 60 tons that's 100 tons of monopropellant production gear.. enough to refuel the landers and send them back up to L1 with payload of extra monopropellant in their tanks and transfer that to interlunar ferry rocket or land more cargo....the hard part will be keeping the propellant cold if we go by ion drive from LEO to L1....

*The SPS at L1 will have low mass thin film GaInP/GaAs solar panels.

The L1 station will consist of inflatables... Genesis 1 modules only amass 1.5 tons.

D Dietzler

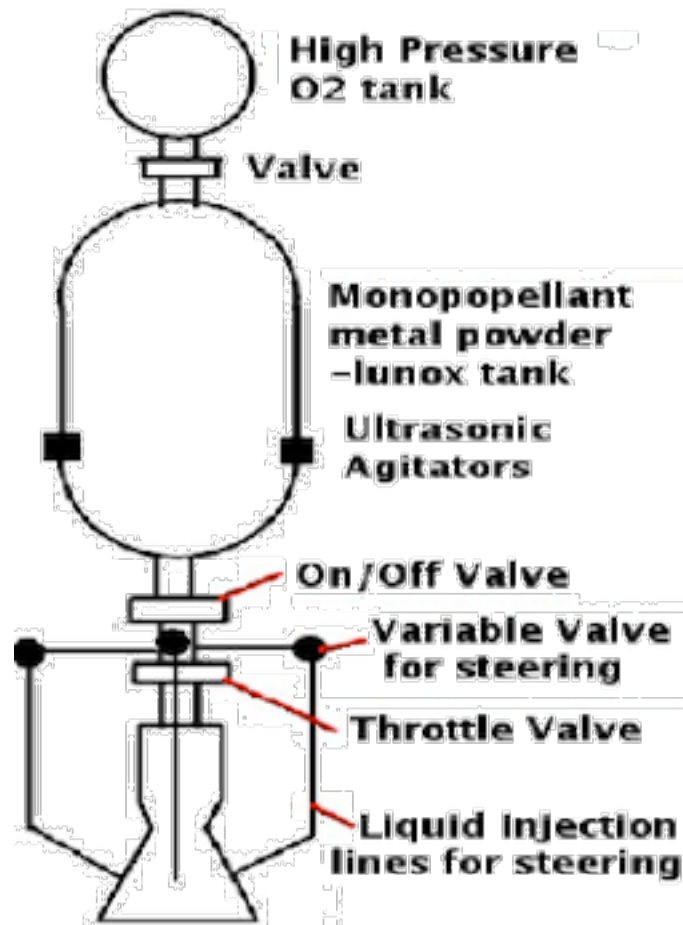

**Author's Postscript to the preceding article
Differences between this and former Visions**

By Dave Dietzler

In the above article, I mention mass driver launch to L5 or GEO, this is not right.† I think the best thing to do would be to aim at' neither L5 or GEO, but at L2, behind the Moon.

From the northwest Imbrium coast we can mine anorthositic highland regolith rich in Al, Ca and Si, mare regolith rich in Fe, Mg and Ti, and KREEPy regolith rich in potassium, phosphorus essential for solar panels and rare earth elements that have many uses, perhaps even high power vacuum tube filaments in pure form or when alloyed with other more common elements, as tungsten is not to be had on the Moon.

Mass drivers built on the Moon from aluminum rings, titanium or concrete supports, aluminum wire wrapped in silica fiber cloth insulation with high power vacuum tube electronics will amass about 625 tons [reference 1]. There will be at least two mass drivers in case one gets severely damaged so launches can continue on schedule. They will launch over the north pole to L2 where Dr. Peter Schubert's electro-magnetic mass catchers are located. The magnetic fields of these devices will draw in iron canisters even if aim due to mass driver exit velocity inaccuracy is slightly off.

Dr. Schubert's mass catcher is superior to the old Kevlar bag catchers envisioned decades ago. Nonetheless, after mass driver launch there will be downrange stations that induce course corrections with various electromagnetic systems to achieve high target accuracy. Iron canisters of plain regolith will be launched as well as canisters of finished bulk products like metal rods, beams, rails, tubes, rolls of sheet metal and foil, spools of wire and cables, rolls of silica fiber cloth, etc. Moon Shuttles will rocket more delicate cargos to the L2 mass catchers, off load them, and the mass catchers when full will haul all this to GEO construction shacks that are built up with lunar materials until they can build SPS and/or power relay satellites.

The construction shacks will have small human crews and over 90% of the SPS construction will be done by teleoperated robots controlled by crews on Earth.

Radio wave lag time between Earth and GEO is but a fraction of a second so good control of robots will be possible. Moon Shuttles could reach L2 and return but these low performance rockets could not reach GEO and return unless refueled in GEO which is a possibility especially after regolith smelting is begun at the construction shacks. There is no giant 100 million ton space colony with 10,000 workers in this vision but greater emphasis is placed on space robot systems with only minimal human presence on the Moon and in space.

Dietzler



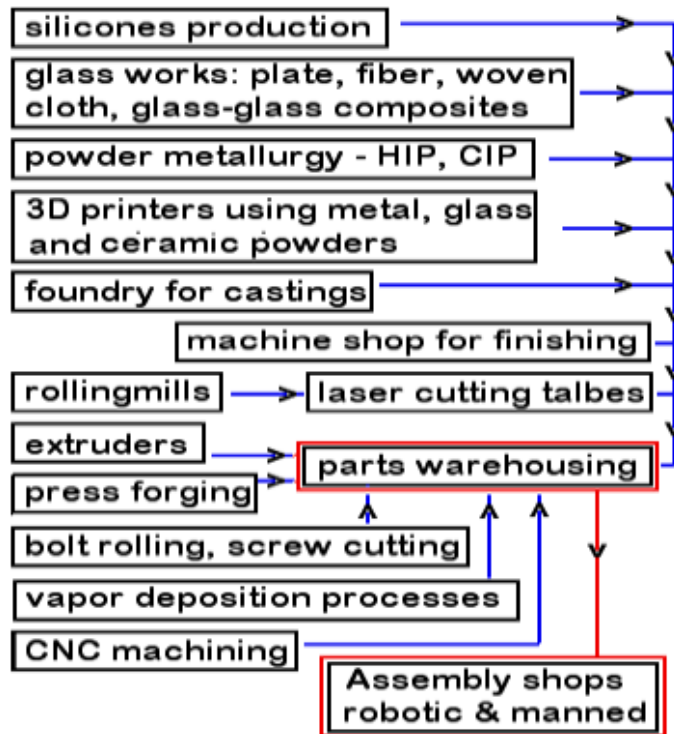
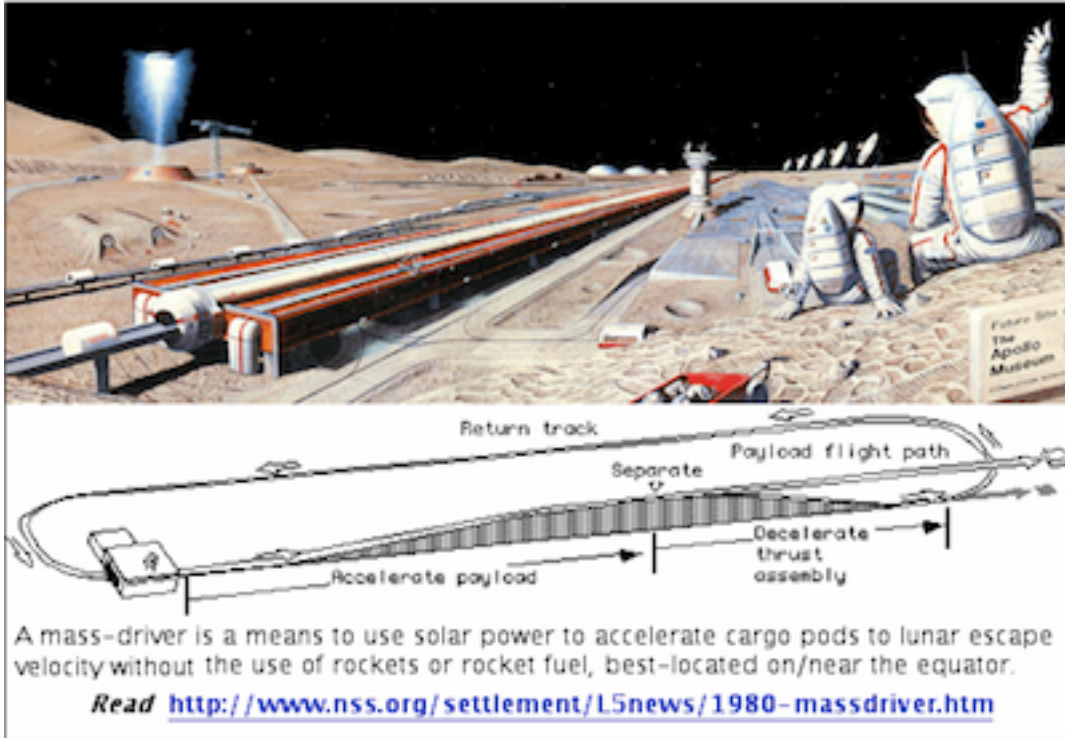

PRODUCTS: vehicles, mining machines, habitat modules, mass-drivers, more machine shops, mills, extruders, forgers, 3D printers, etc. The chart above is focused mainly on processes that use metals.

Materials from regolith: cast and sintered basalt from mare regolith, melted cast and sintered anorthositic regolith that will form a glassy material, ceramics like silica, alumina, calcia & titania; alumino-silicate glass, iron, nickel, titanium, aluminum, silicon, magnesium,

MMM Theme Issues: The Lunar Economy - Years 1-25 Dec 1986 - Nov 2011

phosphorus, potassium, sodium, sulfur, cement, calcium sulfate, and hopefully chromium, manganese and calcium. Limited amounts of hydrogen, carbon, nitrogen, helium. Alloys will include maraging steel (Fe, Ni and Ti), AlSi, AlMg, TiAl and iron aluminides.

Most of these processes can work in vacuum. Vacuum welding or vacuum cementation will affect metals with similar microcrystalline structures when smooth surfaces contact under pressure or for extended lengths of time. Since maraging steel, Al and Ti have different crystalline structures vacuum cementation will not be such a great problem if for instance aluminum plates are rolled between steel rollers or Al rod is extruded in steel extruders or Al parts are forged in steel dies.

3D Laser sintering of aluminum parts will be done in pressurized modules as Al will evaporate readily in the vacuum.

3D electron beam melting of titanium will work better in the vacuum and so will many physical vapor deposition processes to make thin metal parts.

Casting and alloying must be done in a pressurized foundry and machining is best done in some kind of atmosphere with water or oil lubricating coolant. **Silicone chemistry** will be performed in pressurized modules. **Glass** would be poured under pressure. Looms would probably work indoors too.

Powder metallurgy works better in the vacuum. Powder particles vacuum-weld with fewer voids, less porosity in the final product if it is pressed in the vacuum.

Manned assembly shops/garages will have pressure and this will make it possible for humans and robonauts to use pneumatic tools. Electron beam welding and brazing will be done outdoors in the free vacuum by robonauts. Cutting metal plates with lasers could be done in the vacuum also.

D. Dietzler

Additional Appropriate Back Reading

Lunar Overflight Tours MMM # 21 DECEMBER 1988 republished in MMM Classics #3, pp. 4-8

http://www.moonsociety.org/publications/mmm_classics/mmmc3_Jan2005.pdf

MMM # 249 October 2011

A Prelude to Space Industrialization

By Dave Dietzler

In the last issue of Moon Miner's Manifesto I wrote about industrializing space for only ten billion dollars. The money would be raised by selling 20-year zero coupon bonds with a 4.7% interest rate. To pay off the bond holders and make some profit, the Moon mining base would have to be bootstrapped-up and mass drivers would need to be built by year five or sooner. The construction shack complete with auto-mated beam-builders would have to be up and running by year ten or earlier. And 10 GWe of SPS capacity would have to be finished by year 15 at least. Of the \$10B about \$5B would be for rocket launches and \$5B for operations, hardware and R&D.

But there's the kicker. On this schedule there would be no time for R&D. That would all have to be done before selling bonds and embarking on this project! Money for research & development preceding the project would have to come from far-seeing space corporations that launch rockets, operate space hotels and factories in LEO, and other space companies like satellite broadcasters and companies that have launched GEO power relays or SPS from Earth

MMM Theme Issues: The Lunar Economy - Years 1-25 Dec 1986 - Nov 2011

like Solaren, which plans to launch a 200 Mwe SPS and sell power to Pacific Gas & Electric. Money for R&D could also come from governments and private contributors like multibillionaires. The latter is called "angel-I funding." Perhaps large numbers of private citizens would be willing to donate a few dollars each if their names were to be inscribed on sintered basalt bricks used for walls and walkways on the Moon.

Peter Kokh has suggested that some of the needed R&D could be financed on the expectation of profitable terrestrial applications. See: "Spinning-up" Glass-Glass Composites Technology ©1987

www.moonsociety.org/publications/mmm_papers/glass_composites_paper.htm

Presuming we find the money to do the R&D, one of the first things we need to build and test are reusable rockets that I call Moon Shuttles that burn metal powder and LUNOX monopropellant for flight between the lunar surface and L1 space depot. The Falcon-9 launch vehicle was developed by Space-X from a blank sheet to first launch in four and half years for just over \$300 million. The Dragon spacecraft was developed from a blank sheet to the first demonstration flight in just over four years for about \$300 million. See:

<http://www.spacex.com/usa.php>

This proves that space can be done for much less than the enormous multi-billion dollar government projects that we are used to and intimidated by.

An interlunar ferry for flight from LEO to L1 like Peter Kokh's Jules Verne Moonlooper¹ would have to be built and proved out. This vehicle could be built before Moon Shuttles and used to make profits by taking wealthy tourists on round-the-Moon cruises. It would be a test bed for novel propulsion technologies like metal powder and LOX burning engines, attitude control flywheels, cold gas thrusters, in space cryogenic propellant transfer technology and reusable heat shields. Naturally the first flights would be unmanned but once demonstrated there would be plenty of takers for several million dollars per trip. I don't doubt that both these rockets could be built for the same price as Falcon and Dragon were.

¹ "Earlier than you think: Lunar Overflight Tours" MMM Classics #3 pp. 4-8

http://www.moonsociety.org/publications/mmm_classics/mmmc3_Jan2005.pdf

Other technologies we'd need are NEP or SEP tugs to move cargoes from LEO to L1. These could be sold to national space agencies to propel deep space probes. For that matter, Moon Shuttles and Interlunar Ferries might be rented to national space agencies planting research bases on the Moon—more about that later. We'd also need regolith refiners like Dr. Peter Schubert's Lunar Dust Roaster² and All Isotope Separator. Plenty could be invested in that including Moon-make-able versions.

² "How Moon Rocks Can Save The Earth"

www.moonsociety.org/presentations/pdf/

[UsingMoonRockstoSavetheEarth.pdf](#)

I mentioned a 100 ton monopropellant making system. This might use high efficiency GaInP/GaAs stretched lens array solar panels, magma electrolysis, vacuum metal powdering atomizers and monopropellant liquefaction, mixing and pumping systems. With magma electrolysis the propellant would be iron-silicon powder and LUNOX. This might not be as efficient as aluminum and LUNOX but it could be easier to produce as a single electrolysis cell of about one cubic meter could process five tons of regolith every 24 hours with 600 kWe of power to produce about a ton of oxygen and over a ton of iron-silicon. See:

www.nss.org/settlement/nasa/spaceresvol3/ofismse1c.htm

To quote the authors: "The total electrode surface area would be about 30 square meters each (because each electrode is divided into fins, as in a car battery), and the total cell volume about 1 cubic meter. The operating temperature would be between 1300°C and 1600°C depending on the type of container and electrode materials that are ultimately developed. The cell would produce 1.4 tonnes iron-silicon metal, 1 tonne oxygen, and about 3.5 tonnes slag in 24 hours, with an energy requirement of c. 13 MWhr (or 47 GJ)."

MMM Theme Issues: The Lunar Economy - Years 1-25 Dec 1986 - Nov 2011

The 100-ton monopropellant making system would have about 20 electrolysis cells and produce over 500 tons of propellant every lunar day. This would be enough to land perhaps one hundred tons of cargo arriving at L1. Millions of dollars would have to be invested in the development of this machine.

Inflatable space stations like the ones envisioned for the L1 depot and construction shack could be in orbit and making money in a few years. Already, Bigelow Aerospace has orbited unmanned inflatable modules. This part of the project would not require a lot of R&D by the powersat company. If Solaren succeeds with its plan to launch a small solar power satellite from Earth we'd already have a commercially available and proven powersat for the L1 depot that beams power down to the Moon mining base during night-span. We could build on the success of other enterprises.

Even with all this, an International Lunar Research Park [ILRP] becomes essential before any company dares to go into the "solar-power-satellite-built-from-lunar-materials" business. Nobody with common sense jumps into unfamiliar waters. Let's hope the ILRP is directed towards the establishment of SPS rather than a dead end polar science base promising ice and sunshine. If a base is built at the poles, it should be geared towards ice-mining and selling rocket fuel to future industries instead of pleasing only curious scientists and providing corporate and bureaucratic welfare. A north polar location closer to the nearside mare-plex is preferable to the south polar region if the base is to have any commercial future.

An ILRP in western Mare Frigoris or north-western Mare Imbrium on a mare/highlands coast near KREEP terranes would be a first step towards a growing lunar and space industrial infrastructure. I would hate to see a base with no real mission that is scrapped after a short period of operation. This seems to be the fate of the ISS. After eliminating a centrifuge to study the effects of partial gravity on animals, rejection of the TransHab, dumping electric thrusters for reboost and cutbacks in scientific research aboard the ISS, present plans are to de-orbit it in 2020. What a waste! At the very least it might be sold for in-orbit scrap metal or rehabbed and turned into an LEO staging station where astronauts could transfer from Dragon and other capsules to Inter-Lunar ferries, as part of a Moon base program. Chances are the fate of the one hundred billion dollar ISS will be to burn up over the Pacific in nine more years. If an International Lunar Research Park is built with the same mentality I won't even pay attention to the whole taxpayer funded fiasco.

A private venture to propel a Moon Shuttle with NEP or SEP (nuclear-electric or solar-electric) or even tethers to L1, land it and deploy a robotic mono-propellant making system, refuel and ascend to L1 would be far more interesting. I don't doubt that such a project could be done for less than a billion dollars with private money. To make this more interesting, an Inter-Lunar ferry could be propelled to an L1 depot with NEP or SEP, fueled up with monopropellant from the Moon, make a brief retro-rocket burn, aerobrake into LEO and have enough propellant left over to return to L1 with a crew bound for the Moon.

- Proving that we can get there without spending enormous sums of money to rocket fuel up from the Earth at great cost is step one.
- Proving that we can live and work on the Moon using local resources and robonaut/human synergies is the feat we must really achieve.

This will require life support system development and also the development of machines and tools that can work in the vacuum and thermal extremes of the Moon. Designs must be robust, simple and economical. This is a challenge that we must not shy away from. If R&D for a Moon mining base began today and the 20 year project began in 2020 with 10 GWe of SPS capacity going to work in 2035 then only about 0.03% of the world's energy demand (est. 30 TWs) at that time would come from outer space. It would be many decades before exponential growth of space industry led to the creation of an energy source that could seriously compete with fossil fuels at a time when fossil fuel production is on the down slide. That's something the Oil and Gas Barons of the world should think about.

MMM Theme Issues: The Lunar Economy - Years 1-25 Dec 1986 - Nov 2011

So far I have talked mostly about getting to the Moon. So much more could be said about construction on the Moon and in space. Building 10 GWe of SPS capacity will not be easy. A powersat this big would amass about 200,000 tons and be ten kilometers on a side. One hundred powersats rated at 100 MWe would each be one kilometer square, assuming 100 watts per square meter and very high efficiency of electricity to microwaves conversion.

How will we build such large structures in space? One of the keys to this will be a device called a beam-builder. From T.A. Heppenheimer's Towards Distant Suns (1979) chapter 6: Large Space Structures we read: "So it was that NASA's Marshall Space Flight Center awarded a \$635,000 contract to Grumman to build a "Space Fabrication Demonstration System"; that is, a beam-builder. The first such device was completed and delivered to Marshall in 1978. On May 4, 1978, it produced its first beam in ground test.

The beams it fabricates are both lightweight and strong. A one-hundred-foot length weighs only 85 pounds, yet will support a load of 1,260 pounds. The beams are triangular in cross section and a meter deep. (The depth of a triangular beam is the distance from one corner to the opposite side.) They are made up of long strips of angle aluminum supported by cross-braces. The long aluminum edge members are formed from rolls of sheet aluminum; the machine pulls out aluminum strips from the rolls and forms them into the proper angled shape. The cross-braces are made beforehand and packaged in magazines, which fit to the side of the beam builder. They are withdrawn automatically, somewhat like giant staples, and the machine automatically welds them to the edge members. With one supply of rolls of sheet aluminum and of full magazines of cross-braces, the machine can turn out a thousand feet of beam in as little as two hours."

This is quite impressive. A beam 3000 feet long, about one kilometer could be built in only six hours. With several of these machines at work attached to a large fixture at the construction shack we could churn out the frames for powersats in just days or weeks. However, this has never been done in space; not even experimentally as was proposed by the early space colonization people. Grumman already built a beam-builder for less than a million dollars.

It seems that before we embark on our low budget ten billion dollar plan to get into the space energy business we should test beam builders and other robotic systems in space.

What would it cost with Falcon rockets to build a large GEO telecommunications platform to prove out this technology? Would the project turn a profit? We can only hope so. Perhaps the thing to do would be to build a robotic construction shack in LEO and propel it with electric drives to GEO and produce large telecommunications platforms for sale. This would be rather expensive because materials would have to be launched from Earth, but there's a lot of profit to be made in the satellite business and the number of slots in GEO is shrinking.

It would take a lot of nerve to work out all the technology on paper and on computers and on the ground, then risk ten billion dollars to tackle the challenge of building one hundred powersats each a kilometer square or an enormous powersat 10 km square.

Large quantities of aluminum and silicon would have to be produced on the Moon after bootstrapping up the mining base to the point at which it could produce the necessary amounts of materials and launch them into space with mass drivers also built on the Moon. The construction shack too would have to be built up with parts made on the Moon. Could it all be done by a crew of about 35 workers and ten times as many robots? Preplanning of a million details would be necessary. Certainly, this would be an adventure in capitalism that many would scoff at and recommend better uses for their money.

Manufacturing silicon solar panels for the powersats is another challenge that must be met. This has never been done before and would have to be demonstrated at the ILRP and construction shack. The same aluminum sheet rolls used to build the frame with beam-builders could be used as back plate for the solar panels and reflectors to increase solar panel output.

Silicon layers might simply be vapor deposited on the aluminum sheets. To produce one hundred square kilometers of silicon panels in five years would be a challenge like no other.

MMM Theme Issues: The Lunar Economy - Years 1-25 Dec 1986 - Nov 2011

One problem that is faced is the degradation of solar panels in space due to radiation. This might force a rethink of the whole powersat design. Solar thermal SPS might be the answer. Heat engines in space could reach very high efficiencies. The SPS would be smaller and consist mostly of a frame, reflectors, boiler tubes and a turbo-generator using hydrogen or helium as working fluid.

What will be more of a challenge—producing vast areas of silicon panels or manufacturing parts for turbo-generators on the Moon mostly with robotics and 3D printers using titanium and electron beam melting in the vacuum? Or would the frames, reflectors and boiler tubes be made in space using lunar materials and the complex turbo-generators built on Earth and rocketed up to GEO? This would increase costs. Solar thermal systems have reached 25% efficiency on Earth. In space 50% at least should be possible; thus, a powersat getting about 500 watts per square meter would only have to have a reflector about 450 meters by 450 meters to generate 100 MWe.

So we can see that billions of dollars of research and development must precede any grandiose plans to build solar power satellites, even for the rock bottom price of ten billion dollars.

Once the process is worked out robots that can work 24/7 will outpace humans in space and construction will involve a lot of repetition. Robots are good at rapid repetitive work and they are reliable.

I have put forth a rather arrogant proposal to industrialize space for only ten billion dollars in capital, but we can see that this will cost much more than that. The risks are great and must be minimized. Nothing like SPS construction has ever been done.

Bootstrapping up a Moon mining base will only be a matter of fairly standard construction and manufacturing techniques modified for work on the Moon, but building large structures in space is a challenge we know little about.

In weightlessness with no wind or rains this should be possible. Even so, as the powersats are rotated to track the Sun they will endure stresses and strains and weak structures would break apart. There will be thermal stresses with the Sun side heating up and the dark side of the structures exposed only to the super cold of outer space.

In conclusion, the challenge of space energy is a huge one. There is far more to this than low cost launches to LEO, transportation to the Moon which will just be an extension of existing rocket technology, and manufacturing on the Moon. Government research can proceed at a leisurely pace, but private ventures relying on interest accumulating capital must work fast, and that adds to the technological problems faced. It also places more demands on the humans working in space as well as the designers. Sixteen-hour days and eight-day weeks might not daunt the most enthusiastic space entrepreneurs, but it will take a special breed to live up to the job ahead.

D Dietzler

Dave Dietzler (“Dietz”) has been the MMM Editor’s **principle partner in brainstorming and illustrating how we can open the Lunar Frontier**, since his first article in MMM # 157, 2002.

A full list of his articles to date is online at:

http://www.moonsociety.org/publications/mmm_classics/Dietzler_MMM_articles_list.html

**The Moon: What’s in it for Earth? Part II:
Lunar Materials to Grow Earth’s Economy**

MMM Theme Issues: The Lunar Economy - Years 1-25 Dec 1986 - Nov 2011

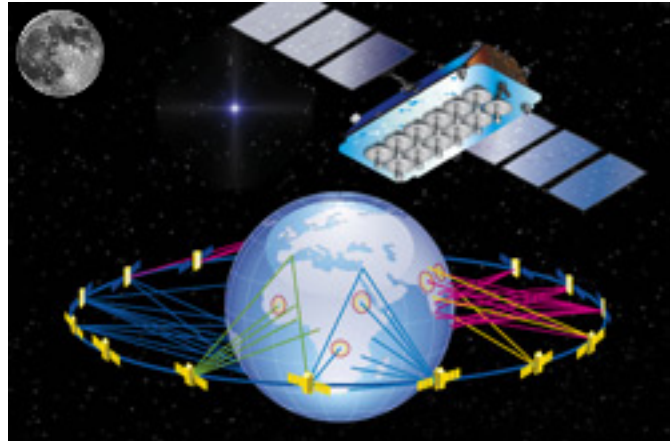

(Photo Credit: Briot/Thales Alenia Space), Moon image added
By Peter Kokh

How the Dream began

In the early 1970s, Princeton physicist Dr. Gerard K. O'Neill publicized a scenario in which we would go to the Moon, mine lunar materials near the equator and sling them into space with an electromagnetic "mass driver." There they would be used to build space settlements to house workers in comfortable and pleasant surroundings, workers who would use more lunar materials to build hundreds or thousands of gigantic solar power satellites to feed our planet's ever more voracious appetite for energy. Thus began the L5 Society. "L5 by '95" was a battle cry.

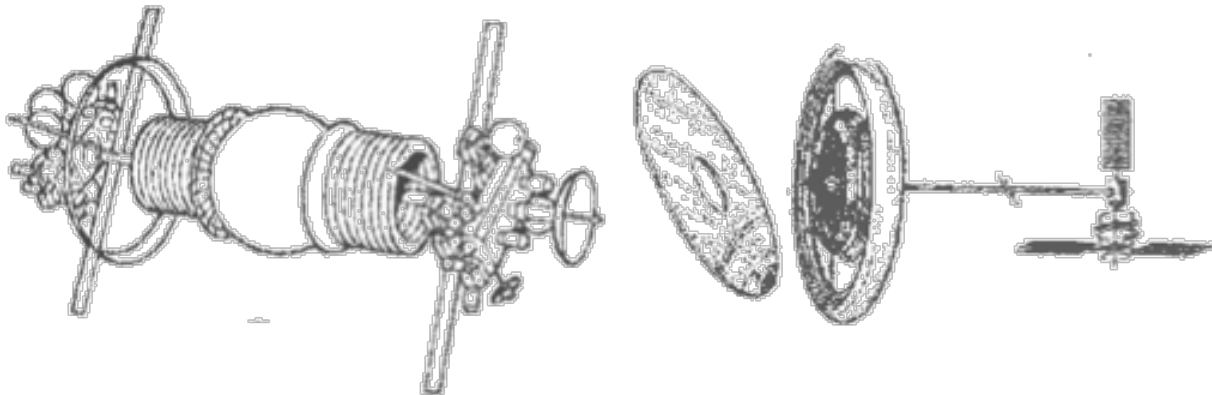

Bernal Sphere (Island 1) and Torus (Island 2) above

In response to Congressional requests, NASA even produced a comprehensive "**Space Resources and Space Settlement**" report in 1977 on the scenario and related ideas for Congress. It is still worth reading and belongs in every space enthusiast's library.

While the scheme was logical, too many of the needed technologies were still in the conceptual stage. To their credit, O'Neill's Princeton team produced successively three working model mass-drivers, each progressively more powerful and convincing.

The logic of using "lunar materials" to build giant structures in Geosynchronous Orbit is impeccable: it would take only 1/23rd the fuel to "downport" (down the Earth's gravity well) material's from the Moon on the gravity well's shoulder down to Geosynchronous Earth Orbit as it would to "upport" them up that steep slope the much shorter distance from Earth's surface. And this, goes the logic, would make solar power sats much less prohibitively expensive.

It is the unique economic potential of Geosynchronous Earth Orbit (Economic Gross Product as of 2010 c. \$275 Billion) that makes the existence of potential construction materials

MMM Theme Issues: The Lunar Economy - Years 1-25 Dec 1986 - Nov 2011

on the shoulder of Earth's Gravity Well so significant. The Moon and GEO are a natural team literally "made in heaven." This is a 2-way economic case of "Location, Location, Location."

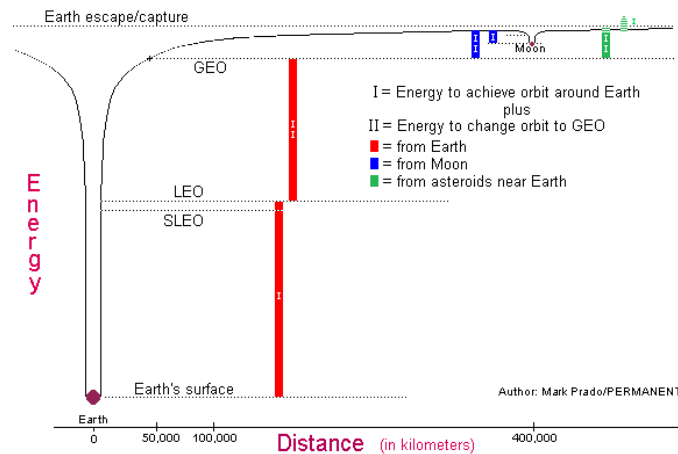

<http://www.permanent.com/images/t-gravity-wells.gif>

Enter The Giggle factor

Many of those old "L5ers" are still around, including this writer. But others, also convinced that Earth's future depends on Solar Power Satellites, but not spiritual descendants of O'Neill, are reluctant to back plans that call for lunar sourcing of materials. It will take too much of an effort, gobbling up too many years of lead time, to industrialize the Moon to the point where lunar raw materials could make a significant and timely difference. And on the NSS Space Solar Power Committee, this division between O'Neillian believers and those never caught up in the L5 Space Settlement dream is quite obvious, with both sides talking past each other.

Long overdue critical distinctions

- 1. Distinction between parts made on the Moon and those made here on Earth** – this part of the puzzle's solution is something I contributed way back in MMM #19, September 1988, pp. 3–4, "A Strategy for Following up Lunar Soil Processing with Lunar "M.U.S./c.l.e." – In this plan, we would seek to produce on the Moon everything needed there that was Massive, Unitary (we need many of the same), and Simple. We would produce on Earth for up-shipment, things that are complex, lightweight, and electronic. Now there are sure to be many things that do not fall neatly into one of these two divisions. But if they can be divided into "MUS" and "cle" subassemblies, then we have the problem of sourcing solved neatly. : Basic simple lunar industries will produce the lion's share of what is needed weight-wise while terrestrial industries will provide the rest. This article is online at: http://www.moonsociety.org/publications/mmm_papers/muscle_paper.htm
- 2. Lowering the expense of developing "in situ" lunar resources into usable building materials** – this is a challenge we addressed even earlier, in MMM #16, June 1988, pp. 3–5, "Glass-Glass Composites" in we suggested that just the opposite of the "spin-off" process, "spin-up" would yield prototypes of technologies needed on the Moon or elsewhere in space at much less research and development cost. Here, instead of a high-cost NASA crash program, entrepreneurs examine the list of needed technologies and examine each for possibly profitable terrestrial applications, then pre-develop those technologies precisely for those terrestrial uses. This article is also online at: http://www.moonsociety.org/publications/mmm_papers/glass_composites_paper.htm
- 3. Pairing the use of lunar materials with the construction space habitats for workers** – giant hollow structures with artificial gravity provided by rotation makes the combined concept a gargantuan one: attractive, yes, affordable maybe not. We must keep in mind the enormous progress made in robotics and teleoperated systems in the past forty years. We will need people on the Moon and in space, but perhaps at least an order of magnitude (factor of 10) if not two (factor of 100) fewer. That changes the economics already.

MMM Theme Issues: The Lunar Economy - Years 1-25 Dec 1986 - Nov 2011

Dave Dietzler brought this up recently in **MMM #242**, February 2011, pp. 7–8 “**O’Neill’s High Frontier Revisited**” – in short, many labor-intensive tasks in space will be performed by robot avatars, partly automated and partly teleoperated from elsewhere.

4. **Building up the needed Lunar Industries** – even given the above distinctions and novel approaches that greatly reduce the challenge of creating an industrial complex on the Moon capable of contributing the major fraction of the mass of Solar Power Satellite construction elements, the idea of lunar industrialization remains “science-fictional” to many. Well the Moon Society has addressed that as well, in our concept (Peter Kokh and Dave Dietzler) for an “**International Lunar Research Park**” – see **MMM-India Quarterly [M3IQ] #2** February 2009 p. 20 and **MMM** pp. 5–6, #224 April 2009. The M3iQ article is online at: http://www.moonsociety.org/india/mmmindia/m3india2_Winter09.pdf
The ILRP would be fully international, and thus quite resistant to any one nation’s budgetary pressures or waning of resolve, witness the International Space Station. The basic enabling parts (spaceport, warehouse, recycling operations, and more) would be constructed by a contractor consortium, so that individual national space agencies could ship up their outpost modules and plug in, free to concentrate on the science and research they came to do. Other corporations and enterprises would be welcome. This is the kind of critter that could in time morph into the first industrial lunar settlement.
5. **Identifying feasible lunar materials and how to produce them** – This is a task to which Dave Dietzler and his “ILRP Team” has dedicated itself. What alloys of iron, aluminum, titanium, and magnesium, the four “engineering metals” are feasible on the Moon, given the low abundance of the usual alloy ingredients for each? So far, the team has identified several feasible options and how we can go about isolating the needed components from the mishmash of moon dust in which minerals have not been concentrated into mine-worthy lodes, absent the geological processes that work on Earth in the presence of water. If you have been a reader of **MMM** over the past few years, you will have seen much of Dave’s work.
6. **Switching to more efficient, cheaper space transportation systems** – We have written often over the years about the flawed philosophy of NASA space transportation architectures. First we need orbital refueling. Second we need to design all components for salvageability and reuse, all the way up the line from Earth orbit to lunar landing. The Apollo and Apollo on Steroids approach of Constellation and now its disguised reappearance as “SLS” are insane. Getting into space has to be about getting into space, not providing money for the constituencies of key Senators and Representatives, or catering to the current stable of industrial-military complex providers. The Commercial Route alone holds hope.

But is anyone listening!

MMM’s circulation is worldwide but in very small numbers. We try to make our presence and work known at the annual International Space Development and other Conferences and have used our “University of Luna Awards” to persons doing research along the needed lines, to help call attention. It is an uphill struggle, but slowly, some of these concepts are being talked about. If we are not mentioned that does not matter as it is the ideas that are important.

There is more work to be done, especially in deciding tradeoffs between what can be most cheaply made and shipped from whence to where. We are convinced that we are on the right track.

MMM # 259 October 2012

Lunar Toll Roads: Taming the Magnificent Desolation of the “Out-Vac”

By Peter Kokh

MMM Theme Issues: The Lunar Economy - Years 1-25 Dec 1986 - Nov 2011

In the pages of MMM, we try to illustrate what is possible and feasible on the Moon, in time. It is important to envision ways in which the Lunar Pioneers will gradually make themselves at home on a dead, dusty, radiation-washed world. Yes, it is also important to illustrate the type of baby steps by which we will establish a "beachhead." But to really motivate ourselves and the actual pioneers who will be inspired to take on the awesome challenges of living on the Moon, we try to show "how we are going to make the Moon a great place to live bit by bit."

Our first roads will be graded and compacted moondust, a row of the removed boulders probably between the two opposite-direction lanes. Early vehicles, without shielding, will be used sparingly by individuals, who may be limited in their allotted time per month out on the exposed surface.

Now fast forward a few decades. We have a thriving frontier world with multiple growing settlements large enough to be called cities. If there are two such, in close enough proximity to generate real "traffic", and whose complementary economies support frequent passenger travel and cargo shipments back and forth, why could we not design and build a "toll road" that makes travel, even frequent travel, rather safe.

First envision a canopy, a bit wider than the roadway underneath, supported on pillars down the middle and here and there along the edges. The canopy is covered with 6 foot or 2 meters of moondust. Travellers will still be exposed to some radiation coming in parallel to the surface along the sides, but this will be a small fraction of the amount of radiation they would receive without the canopy.

Now envision the underside of the canopy a bright sky blue, uplit by sulfur lamps in the base of the pillars. The "black sky blues" will be banished for the duration of the ride.

From the canopy towards the center on either side, will be a suspended monorail. Below, two lanes on either side for trucks, motor coaches, and private vehicles. Add even more hospitable "waysides" at junctions.

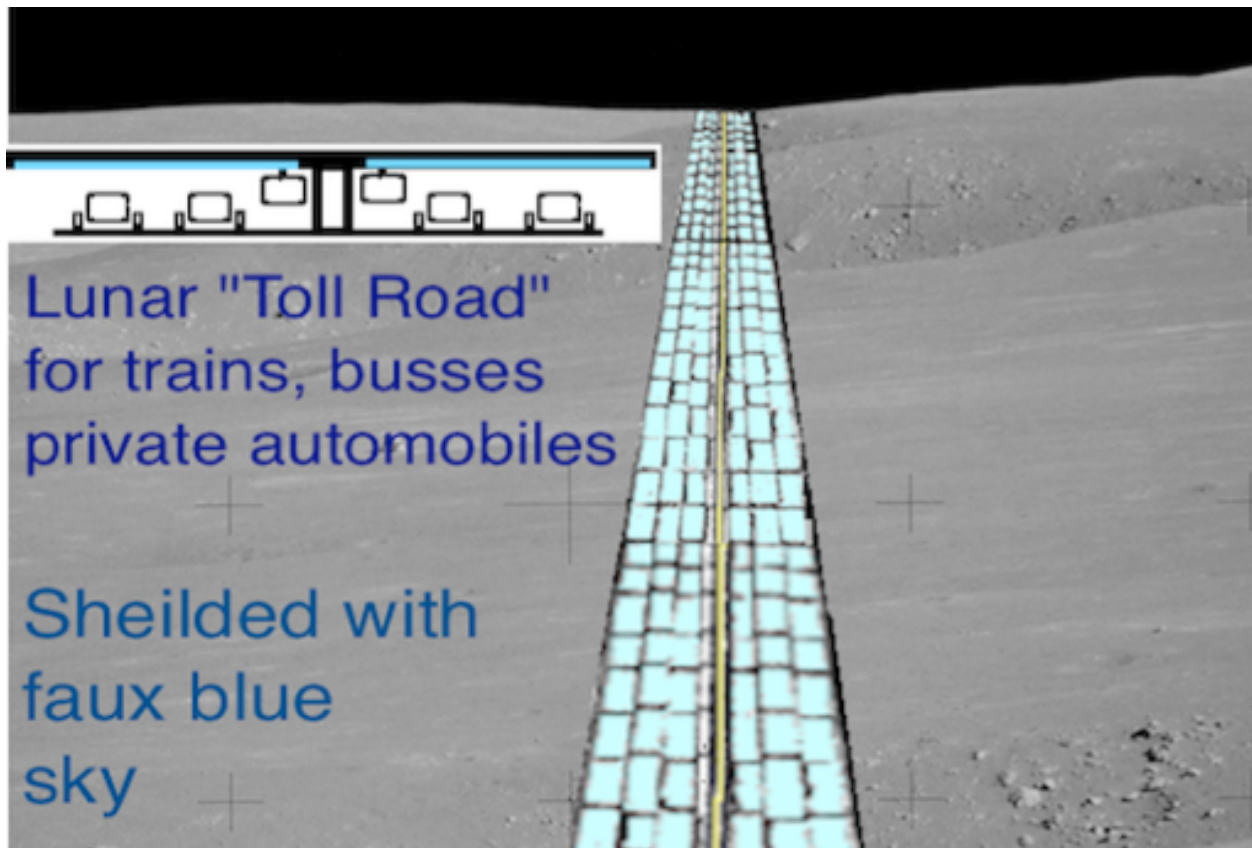

MMM Theme Issues: The Lunar Economy - Years 1-25 Dec 1986 - Nov 2011

Toll Road image by Dan Moynahan, extended at both ends by Peter Kokh – Toll Road cross-section by Peter Kokh

For high traffic corridors between settlements, here is one way that brings together experiences on old Earth and life on the desolate but magnificent landscapes of The Moon. The advantage over a tunnel is that travellers get to see the moonscapes to each side. Granted, pioneers are not going to see something like this until there are a number of substantial settlements with economies that generate traffic between them. But it will come. The chances of a meteorite causing significant damage are slim, but not zero.

Comments and suggestions always welcome. ###

The above articles all shed light on **factors and considerations that will enter into the creation of a vibrant lunar economy.**

There is much more to write about. And this discussion will continue in MMM issues to come. We hope these articles illuminate the possibilities. Most people look up at a barren desolate lifeless globe and cannot picture a thriving human economy. We hope that you will now be less skeptical.

What ancient African ancestor, given a glimpse of the arctic coasts of North America and Eurasia would ever have imagined human cultures taking root there?

Don't ever sell the capacities within the human soul short. We are creatures of the universe, and skeptics to the side, we will slowly expand into that endless realm.

MMM