

"Towards an Earth-Moon Economy - Developing Off-Planet Resources"

# Moon Miners' Manifesto



[www.MMM-MoonMinersManifesto.com](http://www.MMM-MoonMinersManifesto.com)

MMM Classic Themes

Getting There

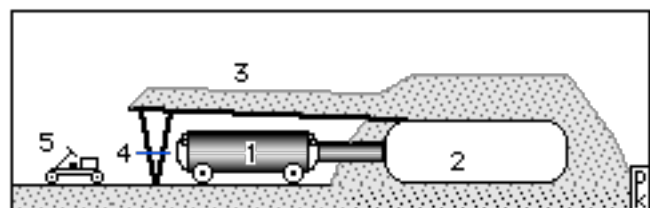
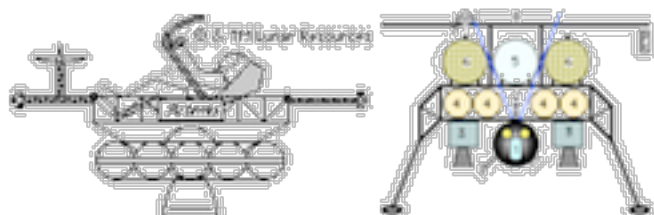
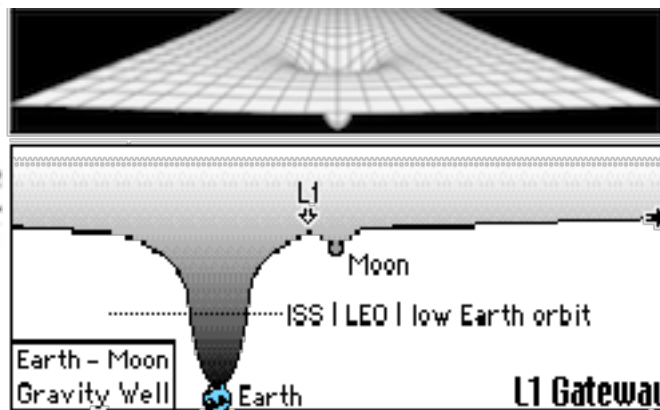
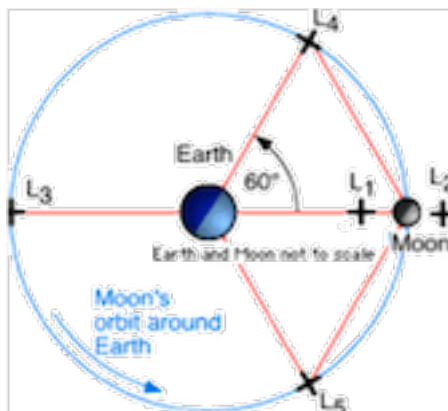
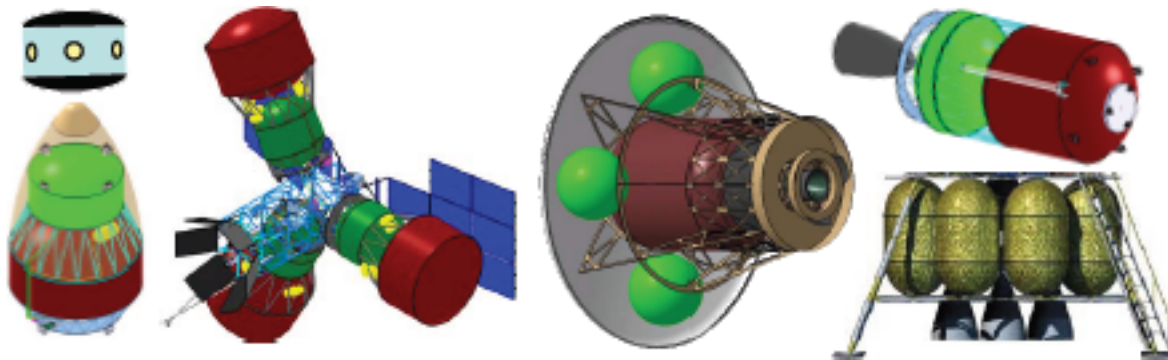
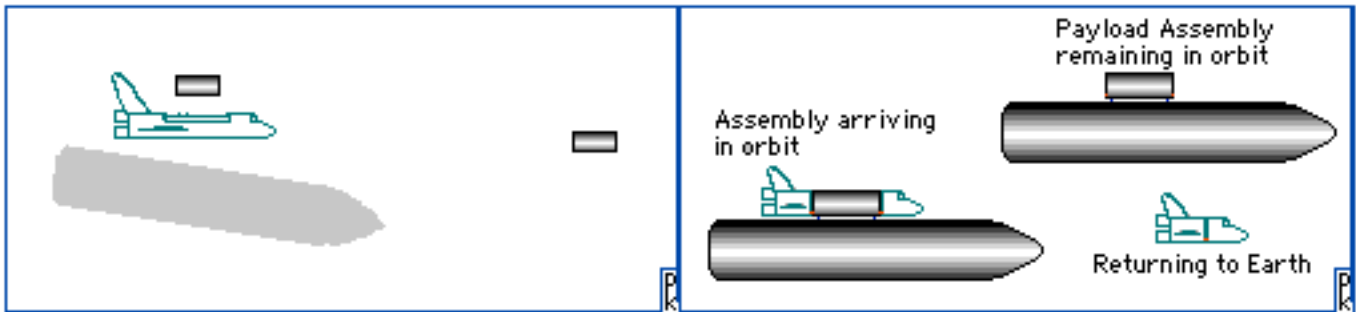

## CHRONOLOGICAL INDEX MMM THEMES: Transportation

### ARTICLES:

MMM #4: BOOTSTRAP ROCKETS

Essays in "M" – The Medium is the Message

MMM #10: Essays in "M" – Means of Transportation

MMM #30: NIMF: Nuclear rocket using Indigenous Martian Fuel

MMM #33 An Easily Lost Chance to Jump Start L5

MMM #46 Lowering The Threshold to Lunar Occupancy (Hostels Paper – Part 1)

MMM #51 Hybrid Rigid-Inflatable Structures in Space

MMM #59 NASA's Explanation for throwing away Shuttle External Tanks

MMM #65 Stowaway Imports

MMM #69 COSMOTIVE, INC.

MMM #81 Toadmobile Conversions

MMM #88 Bursting Apollo's Envelope

MMM #91 From the MMM Dictionary: Space Activist; "Open" Space Frontier; Commercial Space

MMM #94 Lagrange Point Staging for Lunar and Planetary Flight

MMM #96 Spacesuit Aversion

MMM #99 The "Tree" of Cheap Access

MMM #101 Getting there is half the fun

MMM #106 Replenishment of an Orbital Propellant Depot by Means of a Coil Gun; Top Ten Technologies for Reusable Cis-Lunar Transportation"

MMM #107 A Cislunar Ferry; Magsail Asteroid Survey Mission; Magsail Mars Missions; Magsail Stabilization of Lagrange Point Structures; Regolith as Propellant for Mars Missions

MMM #108 Simple ways to Demonstrate Artificial Gravity; In Focus: We need an "X-Prize" for in-orbit Artificial Gravity

MMM #113 "More to Mars;" Sending 12 men to Mars for the price of 4, 24 for the price of 8; Dwarfs and Pygmies

MMM #115 High Sky Aircraft for Venus

MMM #121 Lunar inter-city flights via the "Interchute"

MMM #122 Artemis Project "Space Motorcycle"

MMM #124 Man-rated Mass Drivers/Catchers to and from Lunar Orbit

MMM #128 Reusable Lunar Ferry Design Contest

MMM #141 The MIR Station World Space Monument; Could we have reused the Apollo Capsules, or any part of them?; Shuttle Conestoga; Deadman's Spacesuit Thruster Pack with Fail-Safe Homing Capabilities

MMM #150 The Parable of "Stone Soup"

MMM #159 The Earth-Moon L1 Gateway; Past L1 Station Proposal

MMM # 160 Constructing an L1 Gateway on a "Just-in-Time" Schedule

MMM #164 The Interlunar Cycling Station

MMM #174 Experimental Lunar Rockets

MMM #176 Space Elevators: Drawbacks & Advantages

MMM #198 The Outpost Trap 1. Transportation System Architectures

MMM #209 Thinking Outside the Mass Fraction Box 1

MMM #210 Thinking Outside the Mass Fraction Box 2

MMM #211 Thinking Outside the Mass Fraction Box 3; Augustine Commission Results

MMM #232 An L1 Space Station: Gateway to the Moon

MMM #234 Salvaging the Google Lunar X-Prize "Also-Rans"

MMM #238 "In this decade" = words that doomed the Apollo Moon Venture to a dead end

MMM #241 Lockheed Martin L2 manned station proposal

MMM #242 Telepresence-operated Robonauts; O'Neill's High Frontier Updated and Modified; New Space Age Era of Human-Robonaut Synergy.

## SUB-THEME INDEX: MMM THEMES: Transportation

### ROCKET TECHNOLOGY

- MMM #4: BOOTSTRAP ROCKETS, Essays in "M" – The Medium is the Message
- MMM #33 An Easily Lost Chance to Jump Start L5
- MMM #51 Hybrid Rigid-Inflatable Structures in Space
- MMM #59 NASA's Explanation for throwing away Shuttle External Tanks
- MMM #65 Stowaway Imports
- MMM #69 COSMOTIVE, INC.
- MMM #88 Bursting Apollo's Envelope
- MMM #91 From the MMM Dictionary: Space Activist; "Open" Space Frontier; Commercial Space
- MMM #94 Lagrange Point Staging for Lunar and Planetary Flight
- MMM #99 The "Tree" of Cheap Access
- MMM #101 Getting there is half the fun
- MMM #106 Replenishing an Orbital Propellant Depot; Reusable Cis-Lunar Transportation" technologies
- MMM #107 A Cislunar Ferry
- MMM #107 Magsail Stabilization of Lagrange Point Structures
- MMM #108 Ways to Demonstrate Artificial Gravity; An "X-Prize" for in-orbit Artificial Gravity?
- MMM #141 The MIR Station World Space Monument; Could we have reused the Apollo Capsules?  
Shuttle Connestoga; Deadman's Spacesuit Thruster Pack with Fail-Safe Homing Capabilities
- MMM #176 Space Elevators: Drawbacks & Advantages
- MMM #198 The Outpost Trap 1. Transportation System Architectures
- MMM #209 Thinking Outside the Mass Fraction Box 1
- MMM #210 Thinking Outside the Mass Fraction Box 2
- MMM #211 Thinking Outside the Mass Fraction Box 3; Augustine Commission Results
- MMM #232 An L1 Space Station: Gateway to the Moon
- MMM #234 Salvaging the Google Lunar X-Prize "Also-Rans"

### LUNAR SURFACE TRANSPORTATION

- MMM #10: Essays in "M" – Means of Transportation on Farside
- MMM #46 Lowering The Threshold to Lunar Occupancy (Hostels Paper – Part 1)
- MMM #81 Toadmobile Conversions
- MMM #121 Lunar inter-city flights via the "Interchute"
- MMM #122 Artemis Project "Space Motorcycle"
- MMM #124 Man-rated Mass Drivers/Catchers to and from Lunar Orbit
- MMM #128 Reusable Lunar Ferry Design Contest
- MMM #159 The Earth-Moon L1 Gateway; Past L1 Station Proposal
- MMM #160 Constructing an L1 Gateway on a "Just-in-Time" Schedule
- MMM #164 The Interlunar Cycling Station
- MMM #174 Experimental Lunar Rockets
- MMM #238 "In this decade" = words that doomed the Apollo Moon Venture to a dead end
- MMM #241 Lockheed Martin L2 manned station proposal

### MARS TRANSPORTATION to and on the surface

- MMM #30: NIMF: Nuclear rocket using Indigenous Martian Fuel
- MMM #107 Magsail Mars Missions
- MMM #107 Regolith as Propellant for Mars Missions
- MMM #113 "More to Mars;" Sending 12 men to Mars for the price of 4, 24 for 8; Dwarfs and Pygmies

### ASTEROID TRANSPORTATION

- MMM #107 Magsail Asteroid Survey Mission

### DEEP SPACE TRANSPORTATION

- MMM #115 High Sky Aircraft for Venus

## TRANSPORTATION & PRIVATE ENTERPRISE

- MMM #46 Lowering The Threshold to Lunar Occupancy (Hostels Paper – Part 1)
- MMM #51 Hybrid Rigid–Inflatable Structures in Space
- MMM #65 Stowaway Imports
- MMM #69 COSMOTIVE, INC.
- MMM #81 Toadmobile Conversions
- MMM #96 Spacesuit Aversion
- MMM #99 The "Tree" of Cheap Access
- MMM #108 Simple ways to Demonstrate Artificial Gravity; In Focus: We need an "X-Prize" for in-orbit Artificial Gravity
- MMM #121 Lunar inter-city flights via the "Interchute"
- MMM #122 Artemis Project "Space Motorcycle"
- MMM #124 Man-rated Mass Drivers/Catchers to and from Lunar Orbit
- MMM #128 Reusable Lunar Ferry Design Contest
- MMM #159 The Earth–Moon L1 Gateway; Past L1 Station Proposal
- MMM # 160 Constructing an :1 Gateway on a "Just-in-Time" Schedule
- MMM #174 Experimental Lunar Rockets
- MMM #198 The Outpost Trap 1. Transportation System Architectures
- MMM #209 Thinking Outside the Mass Fraction Box 1
- MMM #210 Thinking Outside the Mass Fraction Box 2
- MMM #211 Thinking Outside the Mass Fraction Box 3
- MMM #242 Telepresence–operated Robonauts; New Space Age Era of Human–Robonaut Synergy.

### MMM #4 – April 1987

## BOOTSTRAP ROCKETS

### WHAT THE LUNAR COLONY WILL NEED MOST URGENTLY: A LEO–TO–LUNA FERRY THAT RUNS ON 100% LUNAR FUEL

By Peter Kokh [kokhmmm@aol.com](mailto:kokhmmm@aol.com)

J. Alex Gimarc in his December 1st 1985 dated report to SSI on Space Shuttle External Tank Applications, section IV–A, discusses orbital disassembly of the ET and melting and powdering of the aluminum for use as a fuel to burn with cryogenics (LH2/LO2) scavenged from the ETs in a hydrogen / oxygen / aluminum based rocket engine in a 1:3:4 mix with a specific impulse (Isp) of over 400 seconds. Despite the high costs of engine development and the orbital melting/powdering facility, the economics of so much ET aluminum available already in orbit are such that this technology would greatly enhance the possible scope of orbital transfer operations

But why do space enthusiasts continue to espouse and settle for developments which are NOT ON THE ROAD to ultimate goals? If all that is wanted is a token science base on the Moon and perhaps a robotics–operated mining facility / mass–driver launch system, okay; but then the hypocrisy about favoring settlement of the Inner Solar System should stop. Such an engine, discussed by A. H. Cutler (in Aluminum Fueled Space Engines to Enhance Space Transportation System Effectiveness, Springboard to the 21st Century, NASA / ASEE Summer Study, 1984, by A. H. Cutler) and alluded to by Gimarc will not serve as the bootstrap rocket needed by a Lunar Colony to support itself without wholesale handouts from Earth.

**Getting to the Moon only counts if we do so in a manner which allows us to stay there and thrive no matter what non–supportive political–economic decisions are made on Earth. To this end only an engine that burns Moon–sourced fuels exclusively will do. With such an engine, the Earth to Moon freight bill would reduce itself ( so far as bottom–line balance of payments are concerned ) to no more than the Earth to LEO ( Low Earth Orbit ) cost.** The Moon could pick up cargo and settlers in LEO and transport them the rest of the way essentially free.

[The above was written more than a decade before Lunar Prospector's confirmation of substantial water-ice reserves at both lunar poles. Since that discovery, many have called for using this resource to produce liquid hydrogen and liquid oxygen rocket fuels. This would constitute a one time non-recyclable squandering of a limited resource that took hundreds of millions of years to be deposited. The "rocket jocks" who couldn't care less about lunar settlement and only want to jet set around the solar system on voyages of discovery, can scratch their itch elsewhere. The writer stands adamantly opposed to the production of rocket fuels from lunar polar ices when they are not necessary. Once we are this far out on the shoulder of Earth's gravity well, hydrogen-free fuel combinations with a lower Isp produced locally on the Moon will do quite well. PK.]

The aluminum rocket IS the answer, of course, but without the costly Isp enhancing hydrogen purchased from Earth sources. Burning powdered Lunar aluminum with liquid Lunar oxygen, O<sub>2</sub> ( possibly enriched with ozone, O<sub>3</sub> ), in a hybrid engine will not have the high Isp performance we have grown used to, but it will be superior to the CO/O<sub>2</sub> fuel system now being favorably considered for Mars based operations.

[Other metallic fuels worth investigating are iron, especially as powdered unoxidized iron is abundant in the surface regolith and needs only a magnet to harvest. PK]

Whatever problems there are in development of a working Al/O<sub>2</sub> engine pale into insignificance in comparison to the rewards. Those with the right stuff or can-do mind-set will not be discouraged by apparent "obstacles." Meanwhile, the H<sub>2</sub>/Al/O<sub>2</sub> rocket is but an expensive distraction that wins the battle of orbital transfer operations but loses the war of space settlement. It must be resisted. – MMM

The above article is online at :<http://www.asi.org/adb/06/09/03/02/004/bootstrap.html>

## Essays in "M":

### Marshall MacLuhan: "The Medium is the Message"

By Peter Kokh < [kokhmmm@aol.com](mailto:kokhmmm@aol.com) >

**M is for Marshall MacLuhan**, Canadian communications theorist and for his well known dictum: "The **Medium** is the **Message**." Translated from communications-speak into rocket-jargon, this comes out as

**"The Vehicle is the Payload"** (If you are at all honest about efficiency!)

Space enthusiasts are known to cry in their beer about the low payload to fuel ratio of the rocket and/or shuttle system. But it is low because

- 1) We throw a good deal of the vehicle=payload away, i.e. the External Tank (ET) and
- 2) We return to Earth more than is necessary (just the engines and cabin) i.e. the shuttle hold or payload bay. Both ET and hold could be redesigned to do double duty as payload and then, presto, instant heavy lift vehicle.

NASA is charged by the government (with our acquiescence) with short range goals and thus does not look past the objectives of the mission at hand, or missions in the planning stages. "Obstacles" are seen as things to be avoided, not as "challenges" to be embraced. But many of us have learned one of life's most valuable lessons: every "obstacle" is a golden opportunity in disguise. It's a "right stuff" mind-set for successful living.

Yes, the ET's orbit, as delivered, would not be stable – we need to experiment ASAP with the rotating tether simultaneous boost of the ET into higher storage/parking orbits and fuel-saving de-orbit of the shuttle orbiter.

Yes, the ET is "wet": the remaining cryogenic fuels are a source of water and electrical power (both via fuel cell) and can be used as station-keeping fuel and for orbital maintenance.

Yes, it would take too many man-hours to retrofit the ET as a Lab. But where the ET's spaciousness is needed is not in the labs/work environments but in the habitat/off-hours environment for which far simpler and lower tech outfitting is required.

It is not enough for the newly formed External Tank Company (ETCO) to ask to take delivery in orbit of spent ET's for commercial marketing. As a precondition, ETCO should be required to buy an unused ET, for use in ground-based practice in retrofitting. ETCO could also save itself time and trouble

in orbital retrofitting by developing such things as a non-degassing SOFI (spray on foam insulation) which NASA would then be required to use.

Along with the ET + Habitat payload, a Shuttle II could be designed in modular fashion with engines and reduced wings/tail in rear, cabin in front, and a larger lab module being the entire midsection (not just within a hold, and conveniently pre-attached to the ET/Habitat-to-be, passageways and all.) The lab module would have a spinal cord which plugs into both the engine/wings module and the cabin module through male/female connection so that both ends, after release of the habitat/lab complex can reconfigure and deorbit together.

in the current STS configuration, only the contents of the Shuttle Payload Bay are “payload” – a very small percentage of the original Launch Vehicle assembly. The intact cargo carrier orbiter returns to Earth and the External Tank is scuttled just before it would have entered orbit. The package “delivered” to space is just a small fraction of what it could be.

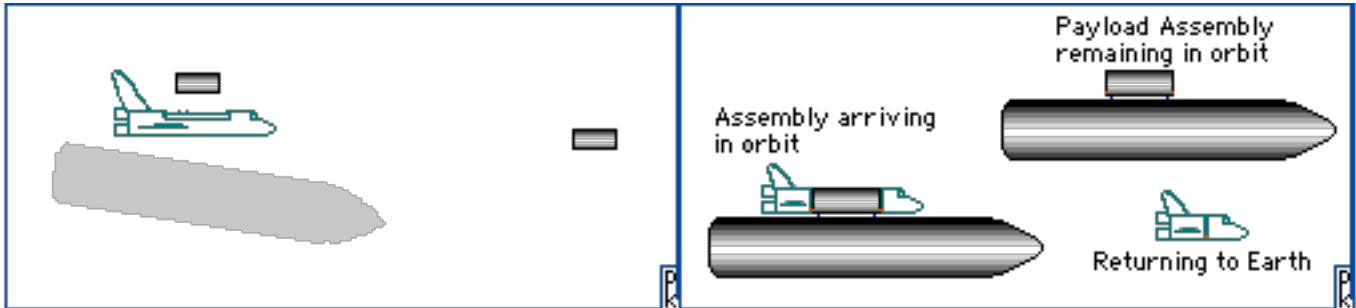

In the radically reinvented space transportation system, the return “orbiter-tug” is much smaller than today’s shuttle (smaller wings & tail and no payload bay. All these weight savings are reinvested in a larger payload structure that remains attached to the External Tank which is taken all the way to orbit, for minimal extra fuel.

The smaller return vehicle (less entire mid-section + payload) needs smaller wings and tail. Weight savings here can be reinvested with the ET in the form of a micrometeorite shield. The major weight savings formerly invested in payload bay hold and doors can be reinvested in an Aft Cargo Compartment (long studied and planned for) for the ET to carry retrofitting supplies, and/or in pre-filling the empty volume of the ET’s InterTank with the habitat’s life support system, and/or a more massive lab module.

Why cry in our beer when by tossing out the baggage of a totally inappropriate mindset we can thus vastly improve payload to fuel ratio by a couple of hundred percent? **MMM**

**MMM #9 - October 1987**

**ESSAYS IN ‘M’**

By Peter Kokh

**M is for Medium range Missiles**, the so-called “intermediates” whose days seem to be numbered. Let’s throw out the warheads [read “bathwater”] but not the missiles themselves [read “baby” ]. Instead, Let’s begin a letter writing campaign to convince the powers-that-be to invest the costs of missile-scraping in a feasibility study to find ways of ganging these rockets-about-to-be-orphaned in stages or clusters in such a way as to provide enough thrust to boost some of our growing payload backlog into orbit, with preference given to planetary and Earth-science missions, continually being bullied to the back of the queue. This won’t hurt budding entrepreneurs and commercial launchers. There’s enough of a workload for everybody. **MMM**

**MMM #10 - November 1987**

**ESSAYS IN “M” Focus on Farside**

By Peter Kokh

**M is for Means of Transportation** to and from a Farside Astronomy site.

Powered portions of rocket (suborbital or not) landings and ascents to and from the lunar surface, ought not to be allowed in line-of-sight from a Farside Radio Astronomy installation in order to avoid interference. Instead "Farport" ought to be located at the end of a surface road from the radio telescope facility at least ten or more degrees away and around the Moon's curvature [c. 200+ mi or 300+ km]. It might be best to locate Farport inside the farside zone which is within line-of-sight of the L4 and L5 Lagrange points at all times, say within 35° of the central Farside meridian. Then communications too would be routed via-surface cable to Farport before being relayed to/from the S.E.T.I. telescope facility.

**MMM #30 – November 1989**



**Nuclear rocket using Indigenous Martian Fuel**  
 An Enabling Technology for Manned Mars Missions  
 with Global Access in a Single Launch

[Body of Paper Condensed by MMM Editor]

Robert M. Zubrin, Martin Marietta, Astronautics, Denver, CO

**ABSTRACT:** This paper presents a preliminary examination of a novel concept for a Mars descent, ascent, and exploratory vehicle. Propulsion is provided by utilizing a nuclear thermal reactor to heat a propellant gas indigenous to Mars to form a high thrust rocket exhaust. Candidate propellants whose performance, materials, compatibility, and ease of acquisition are examined include carbon dioxide, water, methane, nitrogen, carbon monoxide, and

argon. Ballistic and winged supersonic vehicle configurations are discussed. It is shown that the use of this method of propulsion potentially offers high payoff to a manned Mars mission both by sharply reducing the initial mission mass required in low Earth orbit, and by providing Mars explorers with greatly enhanced mobility in traveling about the planet through the use of a vehicle that can refuel itself each time it lands. Utilizing the nuclear landing craft in combination with a hydrogen fueled nuclear thermal interplanetary vehicle and a heavy lift booster, it is possible to achieve a manned Mars mission in one launch.

**INTRODUCTION:** Interplanetary travel and colonization can be greatly facilitated if indigenous propellants can be used in place of those transported from Earth. Nuclear thermal rockets, which use a solid core fission reactor to heat a gaseous propellant, and which were successfully developed during the 1960s under the ROVER/NERVA

programs as hydrogen fueled interplanetary transfer vehicles, offer significant promise in this regard, since, in principle, any gas at all can be made to perform to some extent. In this paper we present a preliminary examination of the potential implementation of such a concept in the context of manned Mars missions. The vehicle in question we term a NIMF: Nuclear rocket using Indigenous Martian Fuel.

**Candidate Martian Propellants**

The atmosphere of Mars consists of 95.0% carbon dioxide [CO<sub>2</sub>], 2.7% nitrogen [N], 1.6% argon [A], all of which are candidate fuels for NIMF. Water could also be used after harvesting ice or permafrost. Carbon monoxide [CO] and methane [CH<sub>4</sub>] can be produced from the above atmospheric gases by processing.

**Table 1: Ideal Specific Impulse of Martian Propellants**

Temp °K	CO <sub>2</sub>	H <sub>2</sub> O	CH <sub>4</sub>	CO/N <sub>2</sub>	A
** 2800 283	370	606	253	165	

3000	310	393	625	264	172	
* 3200		337	418	644	274	178
3500	381	458	671	289	187	

NB.\*\* 2800 °K = safe operating temperature per extensive NERVA testing \* 3200 °K may eventually be attainable

**Carbon Dioxide** – composing 95% of the Martian atmosphere, can be obtained by pumping the air into a tank. At a typical ambient temperature of -40 °C, CO2 liquifies at 10 ATM for an energy cost of just 84 kW hrs per metric ton. A NIMF engine produces over 1000 MW (thermal). If an electrical capacity of 1 MWe is built in as well, then the 2800 K, 40 metric ton, NIMF would be able to fuel itself for a flight into a high orbit in less than 14 hours! Liquid CO2 has a density of 1.16 times that of water and is eminently storable under Martian conditions.

Since CO2 is so readily acquired, it is a convenient fuel for multiple suborbital hops, allowing a Mars exploration mission to visit many sites (either as a ballistic hopper or as a supersonic winged aircraft. (Figures 1 & 2)

One drawback is that CO2 (and water) would oxidize carbide elements at the high temperatures involved. Instead, high temperature oxide elements, possibly coated uranium–thorium oxide, must be used, and such elements would probably be incompatible with the high Isp hydrogen fuel ideal for interplanetary usage.

**Water:** In the form of permafrost ice, water is commonly expected to be abundant, but it will require an operation of some complexity to harvest it. Once a Martian base is established, locally mined water could function as a near ideal fuel for both Earth return, near Mars, and beyond Mars operations. If a base on Phobos is used for a point of departure, a 3000 °K water propelled NIMF could fly to Earth, aerobreak into a loosely bound orbit, and return to Mars without refueling!

**Methane:** Per the table above, methane would be an excellent high Isp [specific impulse] fuel. It could be produced and stored under refrigeration at advanced surface stations (not suitable for early use or needs). Moreover, it is compatible with conventional NERVA carbide elements. An unresolved problem is that methane would dissociate at the high temperatures involved with free carbons causing coking problems. Experimentation is needed.

**Nitrogen, carbon monoxide, and argon** [see the table] are inferior to the much more readily available carbon dioxide. Further, they require about a hundred times as much energy to produce. However, they have the advantage of not reacting chemically with fuel or cladding materials compatible with hydrogen. Thus the same reactor which uses carbon monoxide for ascent to orbit could also use hydrogen with 950 Isp for interplanetary transfers.

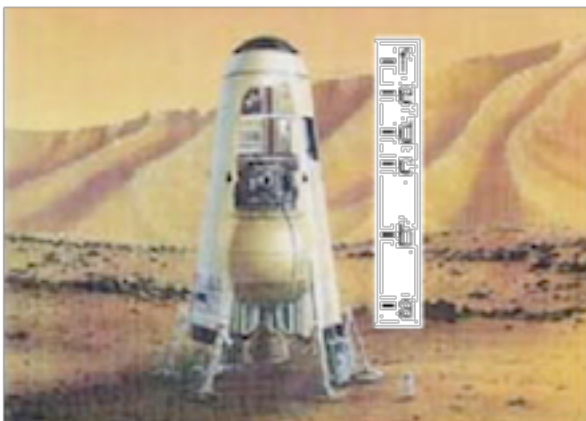

**Right Figure 1**



**Left Figure 2**

**Figure 1:** A NIMF ballistic vehicle on Mars.(by Martin Marietta artist Robert Murray] Read bottom to top **a. Nuclear engine** surrounded by a coaxial fuel tank (when full, augments the solid lithium/tungsten shadow shield with liquid CO2) **b. main spherical fuel tank** **c. Machine deck** with CO2 intake pumps. **d. Habitation deck.** **e. Command deck.** **f. Parachute compartment** (several).

Nb. The NIMF’s fuselage acts as an aerobrake, with a lift/drag approaching unity.



**Figure 2:** Winged NIMF rocketplane on Mars. (courtesy free lance artist Jeff Danelek)

- a. Nuclear engine surrounded by coaxial four-pi liquid shield
- b. The main tank forward of the reactor.
- c. Machine compartment
- d. Habitation compartment
- e. Control deck.
- f. Forward storage area with ramp
- g. Electric rover charged by NIMF reactor
- h. Delta shuttle-like wings for supersonic flight with lift/drag of 4 at Mach 4
- i. 4 VTOL rockets on underside for Harrierlike landings/ascents from/to Mach 1

**A MARS MISSION IN A SINGLE LAUNCH**

Since the days of the Apollo program, NASA’s thinking about manned planetary landings has been dominated by approaches based on an orbiting mothership containing long term living quarters and a small landing craft, a fraction of which manages to ascend to orbit after a stay on the surface. With the advent of NIMF, such an approach is no longer necessary. In fact, since any mass landed upon Mars can be lifted back to orbit using readily available indigenous propellant, it becomes advantageous to abandon the concept of the orbiting mothership altogether, and instead land the entire spacecraft living quarters on the planet’s surface. That is, NIMF and interplanetary vessel are one. Three alternative mission scenarios were examined. In each case, a 40 metric ton NIMF with a 3 person crew departs from a 300 km LEO orbit on a minimum energy trajectory to Mars, lands on Mars, hops around visiting various sites, ultimately returns to Earth via Hohmann transfer orbit.

Scenario 1 uses an orbital transfer vehicle (OTV) to propel NIMF out of LEO, and which is then expended. This is the cheapest option in terms of total fuel use.

In the other two scenarios, the OTV accompanies NIMF to Mars and is stored in Mars orbit for the joint return. In Scenario 2 both aerobrake at Mars, saving fuel while in Scenario 3 the NERVA-OTV brakes via a retrofire to keep it out of the Martian atmosphere. In either variation, artificial gravity could be provided for the long interplanetary trips out and back by spinning the pair at opposite ends of a tether.

**NIMF MANNED MARS MISSIONS: 3 SCENARIOS**

(metric tons)	Scen.1	Scen.2	Scen.3
Mission Mass	73	100	145
Expended Mass	33	53	100

There are numerous mission architectures where an initial manned Mars Mission can be accomplished with a single launch of the STS-Z (125 MT to LEO) or ALS (100 MT to LEO) or even by a single Shuttle-C (80 MT to LEO). Furthermore, repeat missions (craft already in space, needing only refueling and reprovisioning) can be supported by a single shuttle, Titan IV upgrade, or STS-C launch. This contrasts with current NASA plans which would require from 700-1000 metric tons of propellant per mission, 6 or more STS-Z launches! Yet despite their enormous cost and complexity, such mission plans leave the explorers relatively impotent to accomplish much in the way of either exploration or development, as their cryogenic landing vehicle will necessarily restrict their visits to one site, and they lack a substantial source of electric or thermal power i.e. little potential for human exploration of the Red Planet and there. NIMF will allow ready, repeated, and inexpensive access to Mars, opening up a new world to humans.

**MERITS OF NIMF VS CHEMICAL (CO+O2) HOPPERS**

In some respects, these two candidates for getting around Mars (Global Access) are equal. Both obtain a specific impulse in the 280-290 range. While neither engine is a developed technology today, the principles underlying both are well understood, and either could be developed given the appropriate development funds.

However, that’s where the equivalence with the chemical option ends. The energy cost for producing CO and O2 from the atmosphere is more than one hundred times that for simply liquefying the given CO2.

Worse yet for the chemical hopper, we not only have to pay an exorbitant premium for the fuel, but we have to pay for a ground-based nuclear reactor and a significant chemical engineering plant. That's a lot of infrastructure that NIMF doesn't need.

The corresponding features are built into NIMF. If we go with the chemical option, global access will be delayed possibly for years, until the needed development is in place. With NIMF, such global access is an immediate capability.

Since NIMF can refuel itself for return trips, it can go as far one way as its fuel will allow, landing empty. In contrast, the chemical hopper must carry fuel for the return and extra first leg fuel to bring the return fuel along. By the same token, we can afford to build NIMF heavier, with a stronger frame that can carry more instruments and supplies, capable of extended forays.

The chemical hopper must be on target on its return trips, pay attention to boiloff, outgassing, and other potentially explosive and toxic leakage of its cryogenic fuels. Immune to all this, NIMF can recharge the fuel cells on land rovers it carries, not so the chemical hopper.

Highly versatile non-ballistic supersonic winged aircraft configurations are possible for NIMF which is less weight restricted. Because the NIMF propellant is the atmosphere itself, in-flight propellant acquisition systems are possible – not so for the chemical vehicle.

What about safety? NIMF carries a nuclear reactor (however 5 orders of magnitude less radioactive than a power reactor, and not capable of meltdown). This small radioactive inventory represents a small hazard compared to that presented by the chemical alternative to NIMF, which will be virtually a flying bomb, a lightly built structure filled to the gills with toxic gas and chemical high explosives.

#### **OTHER EXOTIC MISSIONS FOR NIMF ALONE**

- A winged automated NIMF condensing its CO<sub>2</sub> from the air, could carry out a Venus surface sample return, collecting ground samples and low level aerial reconnaissance from every part of the planet before returning to orbit.
- A methane propelled NIMF could use Titan as a base for repeat sallies to Saturn's moons, returning to Earth with ground samples and low level observations from each one.
- A water fueled NIMF could explore the Jovian system from Callisto, Ganymede, and Europa.
- Water fueled NIMFs refueling on Ceres, the Trojans, even comets, could explore the Asteroid Belt, and the entire system including Pluto as well as comet sample returns. [RZ/pk]

### MMM #33 – March 1990

## An Easily Lost Chance to Jump Start L5

By Peter Kokh

The headline reads, **“NASA to Build Construction Camp Modules for L5.”** It's too early for an April Fool's Day prank. No, this is for real. While indeed no such announcement has yet been made, and none is forthcoming, **the “truth” is what we DARE to make of it.**

NASA has released preliminary sketches that show current thinking about the configuration of a “Partially reusable” **Lunar Transfer Vehicle** or “LTV” and a fully reusable Lunar Excursion Module or LEV to dock with it via Lunar Orbit Rendezvous (as with Apollo.) In the reference design, the LTV/LEV combo could deliver 27 metric tons of cargo when automated, and 15 tons of cargo plus a crew of 4 when piloted.

The Lander or Lunar Excursion Vehicle would bear a strong resemblance to the Apollo LEM. It would carry twice the crew, 4 persons, and substantially more cargo, 15 tons to less than 1 on Apollo, and could stay on the surface for as long as a month instead of just over three days.

Docking would again be nose to nose as with Apollo. These greatly increased capacities are exiting. But the real sleeper is in the LTV ferry.

The **Lunar Transfer Vehicle** would feature a fully reusable core: engines, hold, crew/control cabin, and aerobrake shield. The aerobrake will allow for return to Low Earth Orbit on virtually empty tanks; and without it, realizing a permanent return to the Moon would be very difficult. Aerobrake technology is due for a 1992 Shuttle launch test using a scale model reentry probe.

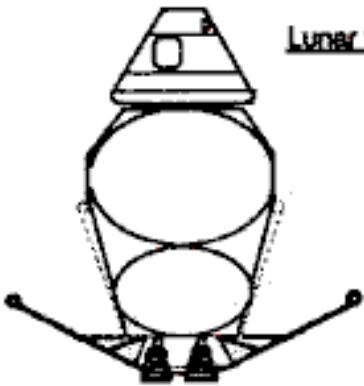
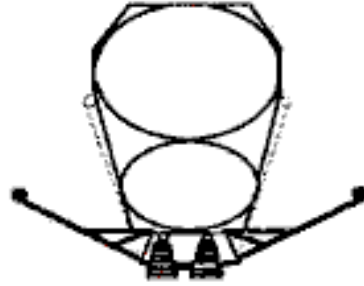
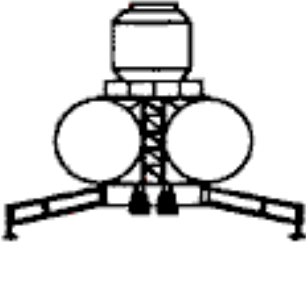
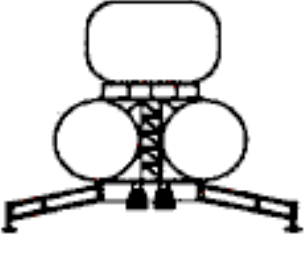
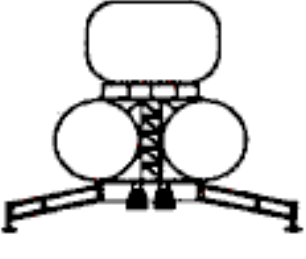
	Lunar transfer vehicle (LTV)	Lunar excursion vehicle (LEV)
	Dry mass: 16.7 t Propellant capacity: 150 t Propellants: LOX/LH <sub>2</sub> O/F Ratio: 6:1 Engines: 4 ASE Thrust: 266.9 kN Isp: 481 sec.  Piloted (LTV-P)	
	Dry mass: 9.7 t Propellant capacity: 150 t Propellants: LOX/LH <sub>2</sub> O/F ratio: 6:1 Engines: 4 ASE Thrust: 266.9 kN Isp: 481 sec.  Cargo (LTV-C)	
		Dry mass: 8.4 t Propellant capacity: 25 t Propellants: LOX/LH <sub>2</sub> O/F ratio: 6:1 Engines: 4 ASE Thrust: 266.9 kN Isp: 485 sec.  Piloted (LEV-P)
		Dry mass: 3.4 t Propellant capacity: 25 t Propellants: LOX/LH <sub>2</sub> O/F Ratio: 6:1 Engines: 4 ASE Thrust: 266.9 kN Isp: 485 sec.  Cargo (LEV-C)

One more element is needed to complete this configuration. the **four expendable fuel tanks!** You reaction to this will depend on whether your intellectual habits set you to be jolted upright, alarm bells ringing, at such apparent stupidity, or whether for you such irrelevantly silly concerns re lost in the beautiful vision of a unique golden opportunity.

### Scratching a Piloted fly-back booster for a throwaway External Tank

When Congressional budget cuts forced NASA to redesign the Shuttle to use reusable solid rocket boosters and an expendable External Tank, instead of a giant piloted fly-back booster, we all lamented. HOW LONG DID IT TAKE (?) before a daring few suggested ways in which tje External Tank (which reaches 98% of the momentum it would need to go into orbit) could be easily boosted into orbit and given new life in a variety of uses? At any rate, we were too busy enjoying the luxury of our anger to foresee any of the opportunities this “substitute” External Tank offered **in time to pre-design and lobby for the few small changes that could have made such reuse much easier!**

Among these design modifications might have been a tank inspection hatch that would be easy to open in orbit (it now has 96 unnecessary bolts!) It is too late to make these changes now, even for ETs yet to be built, because of the long, tedious, and expensive requalification process the ET would have to undergo to satisfy the NASA need for ritual pre-absolution.

### Another chance, for just “pennies”

The four smaller expendable external tanks envisioned for the LTV ferry would be 4.4m (14 ft) wide and some 7m (23ft) long. Each would consist of a longer liquid hydrogen tank, a short liquid oxygen tank, and an intertank connector –on the familiar pattern of the shuttle External Tank.

So? So after the translunar injection burn out of low Earth orbit, **they could be released, with residual fuel, sharing the momentum of the Moon-bound LTV.** Where they will end up, orbiting the Sun or eventually burning up in our atmosphere on the return leg of some very geocentric orbit, will depend upon the exact trajectory of the LTV.

For the price of a very small kick motor and whatever fuel/cargo penalty its inclination would entail, these tanks could easily be given whatever minimal extra momentum or course correction they needed to park them in either a stable High Earth Orbit or even in the stable L4 or L5 Lunar Lagrangian co-orbital fields. **For the price of an inspection hatch and an intertank connector designed with forethought they would be ready, when we are, to be turned into habitat and workplace modules for some Space Construction Shack #1.**

The bill for this modest redesign modifications that will make such a happy outcome possible should be borne by an Enterprise Consortium put together to make use of this potential bonanza. Well

and good, but there will be no point in making this effort if NASA is not first persuaded, in a timely fashion, to allow those modifications in the first plade. That's where we come in.

### Positive Constructive Criticism

If the skeptics are right ("the only thing we learn from history is that we learn nothing from history") we will let this **Platinum Opportunity** go by. Many of us are too in awe of NASA to dream of positive constructive criticism. The rest of us must get off our butts (already broad enough, beam to beam, to reach the nearest asteroid) and organize this campaign with all due urgency. If we wait too long, the opportunity to have an input in the design of the LTV-ET will have passed. By exerting a minimum of leverage, **we have a chance to leapfrog the Buildup of the Lunar Outpost and get something started in Free Space itself.** Space Colony enthusiasts, when is the last time you heard anything so promising?

### Here's what we need to do:

- (1) Call an ad-hoc meeting on this effort at the upcoming 9th International Space Development Conference, Memorial Day Weekend, in Anaheim, California. (Sorry, I can't be there. (written before some anonymous donor sent me a return airplane ticket! Bless her soul!) The purpose will be to organize a workshop to include experts on the (Martin Marietta) External Tank and on its "second-life" possibilities (Tom Rogers, Alex Gimarc, and others), and those who've done past work on "Modular" Space habitat design concepts. Cosponsored by Space Studies Institute and the National Space Society, and interested representatives of industry and commerce, the workshop's goal would be to sketch out a set of reuse-friendly design specifications for the proposed LTV-ET.
- (2) Draw up legislation (Space transportation Act II?) that would (a) mandate that NASA Incorporate, in an economic way, key reuse-friendly features in its design of the new tank, and (b) set up the terms of sale or turn-key of the used tanks to private enterprise.
- (3) Disseminate the design concept and the language of the bill to all concerned: NASA, key Congressional Committees, the National Space Council, and the various space advocacy groups
- (4) Set up an advisory network, like that now pushing HR 2674, to recruit cosponsors for the bill in both houses of Congress.
- (5) Form a corporation with the talent and resources to actually design and build the first Space Habitat or Construction Shack from the tank modules supplied by Lunar Operations in the first decades of the next century (2001 forward).

**We must act now, before some less than suitable NASA design becomes set in concrete! - PK**

MMM #48 - September 1991

## LOWERING THE THRESHOLD TO LUNAR OCCUPANCY

[Hostels]

[A paper presented at the International Space Development Conference in San Antonio, Texas, May 26, 1991 - here serialized in three parts for MMM]

Online: [http://www.moonsociety.org/publications/mmm\\_papers/hostel\\_paper1.htm](http://www.moonsociety.org/publications/mmm_papers/hostel_paper1.htm)  
[http://www.moonsociety.org/publications/mmm\\_papers/hostel\\_paper2.htm](http://www.moonsociety.org/publications/mmm_papers/hostel_paper2.htm)



**An Alternate Concept for both First Beachheads and Secondary Outposts**

Peter Kokh, Douglas Armstrong, Mark R. Kaehny, and Joseph Suszynski - Lunar Reclamation Society  
Forward [snip]

### I. THE VISITING "AMPHIBIOUS" VEHICLE

#### Design Constraints

The design and outfitting of the visiting vehicle is critical to the workability of the hostel concept. The visiting craft must close-connect with the hostel structure if the facilities and equipment it brings are to be used to support any sort of practical routine, and the linked pair are to function together in an integral way. Exercising reasonable precaution, a visiting spacecraft would land a prudent distance from the waiting shelter. Even bridged by some sort of pressurized passageway, the tens or hundreds of meters between would prevent efficient use.

Thus craft must be designed (a) to “taxi” en masse to the porch step of the hostel, or (b)\* to lower a conveniently underslung detachable crew compartment, with its relevant equipment, to the surface so that it can separately taxi the distance on a chassis provided for the purpose. We suggest that this is the design choice to make, as it leaves the unneeded and ungainly landing frame, with the rocket engines and primary tankage, sitting on the pad site. When the crew’s visit to the hostel is completed in a couple of weeks or months, this mobile cabin would uncouple from the shelter and taxi back to the pad site, reconnecting to the waiting descent/ascent portion for the trip back to LLO or LEO. To highlight the amphibious space/surface character of such a vehicle configuration, we have dubbed it the “frog.”

**Figure 1: The amphibious “Frog”**

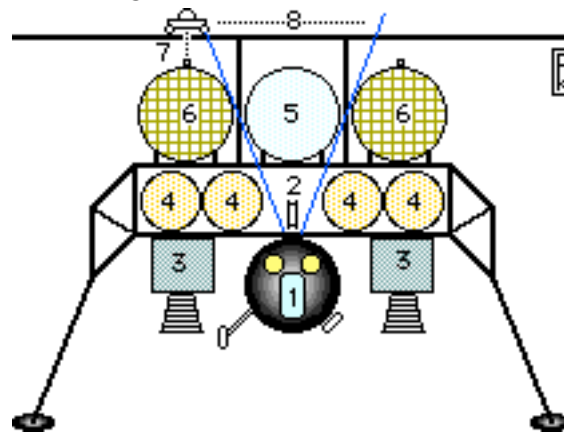

- KEY:**
- 1 Frog (detachable mobile crew cabin) wheel on right retracted, wheel on left extended
  - 2 Winch to lower/raise frog
  - 3 Main rocket engines
  - 4 Fuel tanks – 5 Oxidizer tanks – 6 Cargo pods
  - 7 Overhead crane/winch for cargo
  - 8 Central clear-vision area for top viewport navigation

**Figure 2: Generic Sketch of Hostel Concept**

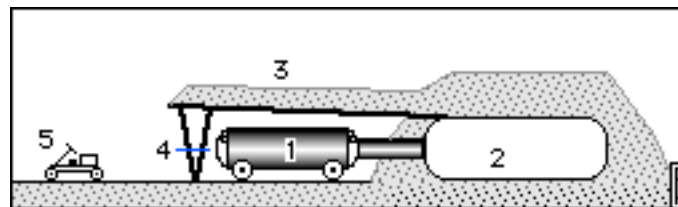

**Frog vehicle docked/coupled to Hostel under shielded open-vac canopy for duration of crew visit.**

- 1 Frog – 2 Hostel – 3 Canopy – 4 EVA airlock – 5 Open-vac rover

**Frog vs. Toad**

The descent/ ascent stage could also be designed to take off without the crew module, picking up a new one at LLO or LEO. The original crew compartment vehicle would continue to serve as a lunar surface transport. This “toad” version, would require a more rugged chassis, more serviceable engine, and some sort of refueling arrangement. If we are to settle the Moon in a self-leveraging way, “toads” introduced to serve remote outposts, may be the ideal ‘dues-paying’ way of importing the surface craft needed before the settlement is able to self-manufacture its own coaches. Thus, whether the crew’s came through open space or across lunar terrain, the vehicle that actually couples with the hostel structure will be functioning as a surface vehicle at the time.

The frog/toad/coach arriving on site could (1) be designed to hard-dock, in which case it must (a) be able to level, orient, and align itself properly for the task, and (b) be able to either lock or deactivate its suspension, perhaps with retractable legs. (If the suspension were allowed to continue floating, the hard-dock seal would be under continual stress with personnel moving back and forth.) Alternately, the vehicle could (2) be designed to link-up with the shelter via a some-what flexible and alignment-forgiving, short pressurized vestibular passageway (a) extending from itself to the shelter, or more logically (b) tele-extended from the shelter to itself by a prompt from within the vehicle. There would seem to be engineering, weight, and safety tradeoffs between these hard- and soft-dock options and we do not suggest which would be the more practical in the short run..

[One criticism of our frog concept brought to my attention at the conference was that, as illustrated, it involved a pair of widely separated engines, one to either side of the centrally suspended mobile crew pod, introducing potential instability if either engine had to be shut down for any reason. Our response is simply that there is so much to be gained by using frog-like vehicles – however they be configured – that it is very much worth the trouble to find or develop engineering work-arounds of this problem feature (e.g. a single top center engine with the exhaust split between pod-flanking exhaust bells). By hook or by crook, there has to be a way! – PK]

### **Outfitting constraints**

To play its part, the coupling vehicle be out-fitted in a way that the capabilities it offers are complementary to those offered by the hostel shelter. It would seem that the repertoire offered would vary according to the customary length of trip for which the vehicle was designed. The possibilities suggest two general classes, the 'commuter and the traveler.

**(1). Commuter class vehicles** would include shuttle craft plying between the lunar surface and either an orbiting depot or a more substantial orbiting mother craft such as an Earth to Moon (or LEO to LLO) ferry. Also fitting the description would be suborbital hopper linking mutually remote lunar sites. In either case the commuting craft is occupied for only a few hours at time. Thus it may not contain berth space, galley (though food stores are likely to be a major part of the cargo), or head, though some emergency-use only arrangements would be a prudent option should the craft go astray or be forced to land far from its destination.

Even here, we have a vehicle which could bring something to a hostel partnership. For both shuttle or hopper will have communications, navigation, and computing equipment which do not need to be duplicated in the hostel. And either will likely have an emergency first aid compartment complete enough to serve the crew in its hostel stay, as well as other emergency survival provisions. Finally, its air recycling equipment (a water recycling capacity is less likely) and ventilation fans, might easily be oversized without too much weight penalty, so as to also serve the hostel space well enough in a close-coupled configuration.

**(2). Traveler class vehicles** would include such landing craft comprised of a shuttle module delivering a "through-cabin" crew-pod transferred from an Earth-Moon (LEO-LLO) ferry. As on the coast to coast Pullman sleeper cars passed on from one railroad to the next in an era now long gone, the crew coming to staff the hostel would ride the same "through-cabin" all the way from LEO, or even all the way from the Earth's surface.

Also in the cruiser category is the "overland" coach (from an established settlement or full base) designed for trips cross-lunar excursions of a day or more in duration. In either scenario, the visiting craft will contain serviceable if cramped "hot-rack" berth-space that can serve in the hostel-hookup as emergency infirmary beds if isolation or quarantine is called for. And certainly the craft will have at least a minimally equipped galley and head (possibly with shower) as well as a compact entertainment center with some recreational extras. Such more fully equipped vehicles would serve especially well as hostel complements, leaving the hostel to provide what it can offer most economically and efficiently: hard shelter from the cosmic elements, and plenty of elbowroom to serve the less expensive low-tech but space-appreciative aspects of daily life -- private bedrooms and communal areas for dining, gaming, exercising, etc. <<< LRS >>>



## HYBRID RIGID-INFLATABLE STRUCTURES IN SPACE

By Peter Kokh

In last month's MMM, we explored some possible architectures that could be useful in realizing the frog-hostel concept for lower threshold, timelier, less expensive yet more extensive lunar occupancy. One of the promising avenues looked at was the idea of rigid-inflatable hybrids in which the rigid component was packed with systems modules and the inflatable component providing habitat and activity volume – all in one ready-to-deploy package.

There is no reason why this concept wouldn't work for space structures just as well as for lunar surface outposts. And indeed there have been some precursor ideas. At the 1990 Space Development Conference in Anaheim, California, J.R. Thompson, then deputy NASA Administrator, shared with us some of his surprisingly unfettered thoughts about real near-term possibilities. Thompson felt there was no reason why the Shuttle orbiter, refueled in orbit, couldn't make a non-landing round trip out to the Moon and back. He imagined the payload bay outfitted with a folded inflatable structure. Once in cruise mode, the payload bay doors would open, the inflatable would be filled with air, and the Shuttle would take on a distinctively conestoga-like appearance, reminiscent of a bumper sticker design produced by Peoria L5 some years back.

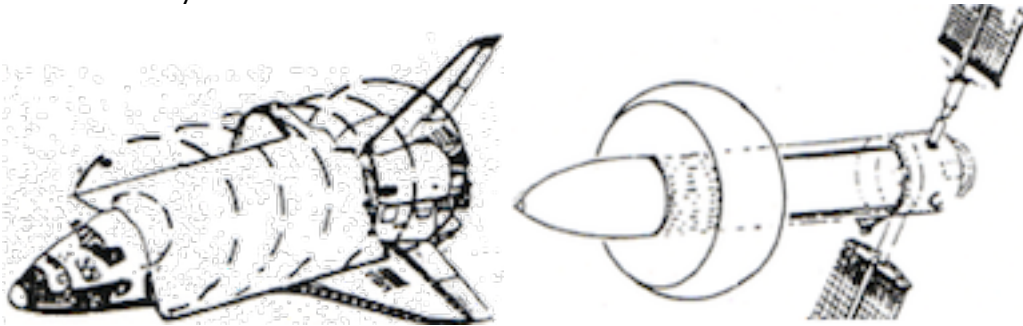

Such an mission could be flown in low Earth orbit, but would be riskier owing to the high concentration of space debris that has accumulated through sloppy, careless, and thoughtless vehicle designs and mission practices. Whether in orbit, or solely on the portion of the circumlunar cruise that lay safely behind the debris zone, such an inflated orbiter mission would be enhanced if the bed of the payload bay were packed with space-lab type modules to structure the use of the volume supplied by the inflatable volume.

To what use could such admittedly temporary volume be put? It could serve as our first "space gym" allowing us to explore the potential of zero-G exercise in a way never before possible. It could allow us to perform physics and processing experiments that required plenty of elbow room. It would be interesting to see how various potential uses would respond to a Request for Proposals.

If we could have a shuttle orbiter hybrid, why not a shuttle external tank hybrid. The inflatable structure could be stored, along with built-in modules to structure the inflated volume, in the Intertank walls between the liquid oxygen tank on top of the stack, and the liquid hydrogen tank on the bottom. The inflated structure could have the shape of a torus or donut girding the intertank. This could be the main crew habitat area, with the ET fuel tanks used for fuel depot storage or other warehousing.

Carrying the shuttle ET with torus crew compartment one step further, if an SSME [space shuttle main engine] cluster pod were attached to the bottom of the stack, refueled our ET with inflated crew collar could become a deep space ranging vehicle making exploratory excursions to Earth-approaching asteroids, for example.

A third space-based hybrid possibility is a payload bay sized space station hab or lab module or a space station connector node module with inflatable component(s) stored in its exterior side walls or end caps. Such hybrid structures could greatly expand the pressurized usable volume of any space station constructed from them. Again, there is the challenge of protecting any inflated component from debris-impact damage.

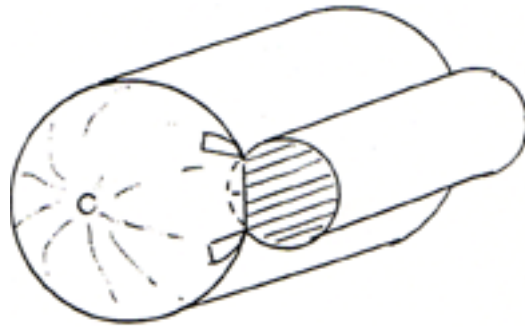

SEND other ideas for space-based or space-plying hybrid structures or for their uses to **MMM**.

MMM #59 - October 1992

## MAILBOX

### **NASA's Explanation of Why it Throws Away the Shuttle External Tank in each and every mission:**

[Ernie Bergman, a long time MMM subscriber and supporter, and a co-founder of the Greater Detroit Space Society, wrote U.S. Senator John Seymour (MI) to complain of NASA policy and Congressional indifference with the respect to the continued "wasting" of a potentially significant "bootstrap" resource, namely the Shuttle ET. Ernie mentioned that there were already a number of well-thought out plans to use the ET.

Seymour passed on this letter to NASA and the letter printed below outlines NASA's reasoning. Thanks, Ernie!]

Thank you for your May 9, 1992 letter on behalf of Mr. Ernest Bergman who suggested that NASA use expended, retrofitted Space Shuttle External Tanks (ETs) as a Space Station.

NASA has no plans to adapt expended ETs for use in the Space Station Freedom program. In the early planning phases of the program, NASA considered the use of ETs as potential building blocks for a Space Station. Based on a thorough assessment, the idea was rejected for several reasons. For example,

[√] the very large size of the ET exceeds NASA's resource capability to outfit it with the equipment necessary for electric power, life support, stabilization, and instrumentation. Further,

[√] due to limited ground-to-orbit lift capability, the ET would have to be outfitted on orbit. In addition,

[√] it would be technically difficult to purge the volatile material from the tank and modify the internal structure so that it could be effectively used.

[√] Maintaining the tank's stability during this activity would be very difficult to accomplish.

The current restructured Space Station Freedom design using a truss and modular design approach offers

[√] a flexibility that would not be possible with a Space Station constructed from ETs. Our design will allow for additional modules to be incorporated into the structure as future needs and resources dictate.

Martin P. Kress, Assistant [NASA] Administrator for Legislative Affairs

[EDITOR'S COMMENT: Senator Seymour accepted NASA's response without question and this helps illustrate what we are up against politically. Fortunately, commercial endeavors need not be bound by such defeatism and sheepish resignation.



Where there's a will, there may or may not be a way. It's certain, though, that when there's no will, there is no way. NASA is poorly motivated to use the ET resource and thus it should not be surprising that the Agency has gone through only the first half of the brainstorming process. It has ferreted out all the reasons why something won't work. Full stop. But then you're supposed to creatively brainstorm all the ways you are going to [stress on determination] "make it work anyway".

In fact, all of NASA's objections can be met – or shown to be irrelevant. Without going into the debate point by point, let's simply escape its terms by changing the rules. If it is in fact too difficult to retrofit a "wet" ET "in orbit", we can nonetheless alter the standard mission profile so as to save them in orbital "reservations", parking them in a high enough warehousing orbit until the day we do have the capacity to remodel them, or mine them for their aluminum and copper.

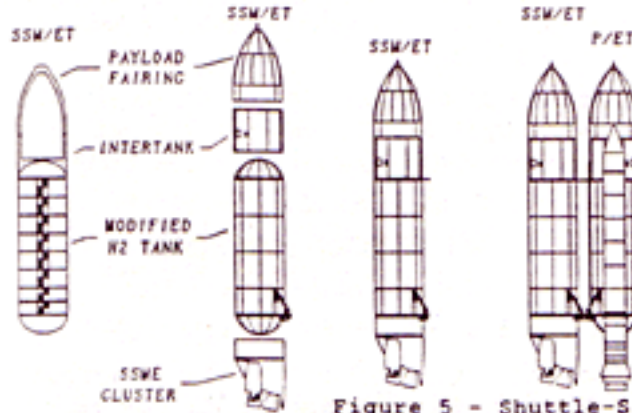

Figure 5 - Shuttle-S

Meanwhile, it IS possible to build ET-hulled modules fully outfitted on the ground, and launch them ready to occupy and connect to auxiliary trusses etc. In the most imaginative piece\* of ET-Brainstorming we've seen to date, J. M. Snead, an SSI Senior Associate from Beavercreek, Ohio describes a "Shuttle-S", a "Shuttle-derived vehicle that carries a ground-modified ET into orbit as the primary payload [which] consists of a modified ET hydrogen tank, intertank, and a top payload fairing that takes the place of the oxygen tank. Following the Skylab example, the ET's hydrogen tank would be converted during production into the primary pressurized module for a large space station."

This Space Station Module ET (SSM/ET) is mounted atop a cluster of Space Shuttle Main Engines (SSMEs) and attached to the regular unmodified fuel carrying ET in place of the orbiter. This yields an estimated allowable total payload for the outfitted modified ET station module of 175,000 lbs including the SSME/OMS/RCS/avionics cluster and OMS/ RCS propellants. The advantages are these:

- 1.the basic components are off the shelf.
- 2.We would not be boosting unmodified ETs but rather "ET compatibles" fully outfitted habitat and lab modules using ET components for a hull – therefore ET assembly lines and ET fabrication facilities.
- 3.(The ET compatible modules would not have to go through a time-consuming and expensive "man-rating" hoop-set for launch since no crew would accompany it to orbit.
- 4.Much more gets launched in a single shot.
- 5.EVA time needed to ready the module for occupancy and use is held to a minimum – below that needed for Space Station Freedom.

Snead's specific design need not be followed but it clearly points the way. While Freedom may ultimately cost as much as \$10B per bed (4), a one module ET-compatible station might cost as little as \$100M per bed (12), 100 times less!

As Snead points out, NASA has chosen to start with a "clean sheet of paper" offering maximum flexibility and efficiency of design. The inescapable penalty is the need to design and develop all new components and the factories to build them, a process that guarantees delays and cost overruns that are not justified by the marginal extras to be gained.

Snead's philosophy borrows a page from the English inventor of radar, Robert Watson-Watt, who describes the "Law of the Third Best":

The "best" never comes. The "second best" takes too much time. Design a product that works – the "third best" – and build it. The third best design is the one which "can be validated without unacceptable cost or delay".

It all comes down to this. Space Station Freedom costs so much because NASA is building it to satisfy a set of priorities totally inappropriate to the opening of the space frontier.

But it also means that **the place to get into the ET station business is**, not Colorado or wherever, but **at Michaud, Louisiana next to the Martin Marietta plant** where newly built ET hulls can be accepted for custom outfitting before transit by barge through the intracoastal waterway to the Cape. In other words, the “real ET company” is an enterprise yet to be formed. **PK**

[\* **SPACE BASE I: Building a Large Space Station Using External Tank Technologies.** Paper at 1991 Midwest Space Development Conf., Dayton, OH by J. M. Snead PE, 4236 Straight Arrow Rd, Beavercreek, OH 45430-1519. ]

In this paper, Snead goes beyond the one ET module station to sketch a 170 person (!) 16 spoke rotating station with 21 ET compatible modules, all for about the price of Freedom! Alternately, four complexes a fourth the size, one each in LEO, GEO, lunar orbit, Mars orbit. His design has at least one definite flaw – much too tight a radius and therefore much too high an rpm rate to provide a tolerable artificial gravity. But it does illustrate the potential of ET compatibles.]

MMMM

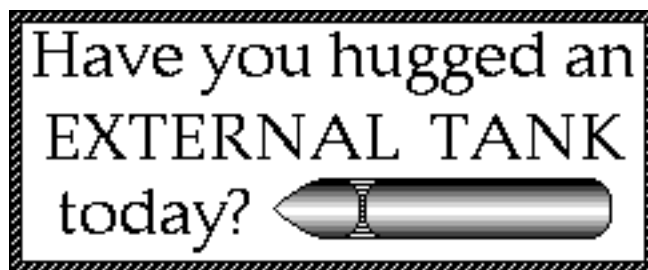

**ORBB - “Orbital Resources Bootstrap Bank”**

The forever lost opportunity to cache in orbit the raw materials incorporated in the External Tanks of just the first fifty successful Shuttle missions now amounts to a loss of:

**3,300 tons of aircraft quality aluminum** high-Cu alloy (can't be made from lunar material)

**86 tons of copper** which does not exist at all in mineable concentrations on the Moon

**150 tons of cryogenic hydrogen & oxygen**

MMM #65 – May 1993



**Using Hitchhiker and Bonus Imports to Hasten Settlement Self-Sufficiency**

STOWAWAY IMPORTS By Peter Kokh

### Three Opportunities for strategic substitutions

There are three basic categories of opportunity to ship to the Moon badly needed “Lunar deficient elements” – strategic metals and volatile feedstocks – virtually “for free”. That is,

- The freight is actually being billed to other Import items, and would still be levied ...

Whether these opportunities are seized and reused or not,

These are (1) containers and packaging materials or “tare stuffs” used to ship the principal items on the Manifest; (2) parts and components of imported items that would normally be made of elements in which the Moon is already well endowed [see the end of the “MUS/cle” article just above]; and (3) cannibalizable parts of the shipping vehicle or of its outfitting that either are not needed for the return trip to Earth and could be replaced there, or which could be replaced with Lunar substitutes upon arrival on the Moon.

In all three cases, play in the “substitution game” is initiated on Earth. In the second and third case, there is a “counter” or “complementary” substitution made on the Moon. In the second case, this match move could be delayed for some time, the endowment being “banked” in the imported item as it is being used. [see previous article].

### **What substitutes for what?**

On the one hand, the stuffs, parts, and components in question are those that would normally be made of elements for which the settlement has no need, namely, those which can be produced economically on location: oxygen, silicon, iron, aluminum, and titanium especially. The operative rally cry here is “**No Coals to Newcastle**” i.e. no ice for the Eskimos, no sand for the Saudis, etc. Shipping or co-shipping items so formulated constitutes no less than a criminally wasted opportunity to bootstrap industrial diversification.

Instead, we want to substitute other metals such as copper, zinc, lead, gold, silver, platinum, etc., or alloys rich in them such as duralumin, monel, bronze, brass, pewter, etc. Where such substitution is impractical, an alternate option is to preferentially use stainless steel or any of several other industrially desirable steel or aluminum alloys for which the alloying ingredients cannot be easily produced on the Moon.

Some constraints apply: the substitute metals must be formulated to perform adequately, and must not involve added weight. The trick is to avoid paying a weight penalty in substituting heavier metals for lighter ones by using less of them or by other tricks. If this pitfall is avoided, substitution costs aside, the actual transportation costs will be nil, charged as “overhead” on the bill for the principal shipment, whether the helpful endowing substitution is made or not.

As to oxygen, it is a principal component – often in the 50% range – of paper, cardboard, wood, plastics, styrofoam, and other materials often used as containers, packaging wrap, separators, and fill. Instead, it will be to the settlement’s great advantage to substitute tare stuffs formulated from low polymer hydrocarbons that can easily be broken down into the constituent hydrogen and carbon – both very precious on the Moon – or used as chemical feedstocks in Lunar industries.

Other substitution possibilities include soaps and waxes and friable or biodegradable compositions rich in those agricultural micro-nutrients or fertilizers in which lunar regolith soils are impoverished. A stuffing and cavity-filler option that could sometimes be appropriate would be to use air- or freeze-dried luxury food items (to be reconstituted with water made with lunar oxygen) (e.g. fruit, milk, eggs, spices) not likely to be produced in the early stages of lunar agriculture and which would add much to special occasion menus and to over all morale and morale-dependent productivity. Such items (along with human wastes from arriving ships) will be much valued accumulating additions to the local biosphere.

Oxygen is also an unnecessary 21% of the Earth air with which cargo holds would normally be pressurized. Instead we could use pure Nitrogen, the extra 21% most appreciated on the Moon. For the return trip, the holds could be pressurized with Lunar Oxygen, either alone or buffered with Argon and Neon scavenged from the regolith by modest heating.

As every gram of pest potentially takes the place of many pounds or tons of food or product in the food chain, pressurizing holds filled with seeds and seedlings with pure Nitrogen, heated to 65° C (150° F) or so could be doubly important. Attention to a whole host of “little” opportunities like this could make the difference to settler self-sufficiency. Lost nickels and dimes add up quickly to real lost dollars.

### **“Changing the Rules”: Cannibalizing Outbound Vehicle Equipment**

Passenger and Cargo ships alike bound for the Moon will contain many components, parts, and items of outfitting that are either not strictly needed for the trip home, or which could be replaced by Made-on-Luna fabrications for the trip back to Earth. If these ships are deliberately designed and outfitted for cannibalization, the cost of off-the-shelf assembly-line-item reoutfitting per flight could ac-

tually be less than the customary one-time individually customized outfitting that has become NASA's one-trick pony.

Certainly this will involve a major paradigm shift for those spacecraft designers and their cheering sections who currently are aware of only two sacred cow choices: Expendable and Reusable – neither of which are anywhere near appropriate for opening the frontier. These two are like Thesis and Antithesis. The Synthesis is to send ship[parts] one way to the frontier for “Reassignment” there. So add Reassignable to Expendable and Reusable. It's a frontier door-buster.

Until industries are in place to fabricate replacement parts, only those items not actually needed for the trip home can be removed upon Moonfall for cannibalization. Gradually, other parts can be replaced on the spot with prepared Lunar fabrications. We'd be removing items made of Lunar deficient metals and alloys and volatiles and replacing them with items made of Lunar abundant materials (iron, aluminum, glass, glax, ceramics etc.) from basic settler industries.

What type items are we talking about? Nonstructural (akin to non-load-bearing) interior partitions; floor, ceiling, and wall panels; interior doors and trim; fuel tanks, eventually even cargo holds, platforms, exterior booms and beams etc.

For ships carrying settler recruits one way and returning empty except for crew, the list includes the partitions and decor panels of individual quarters, dishes, cutlery, and food preparation equipment, cabin furniture and furnishings, entertainment equipment and libraries, beds or berths, bedding and towels, sinks and toilets, even snap-in/snap-out copper wiring harnesses. If you use your imagination, the list gets surprisingly long and potentially all-inclusive.

Indeed, we'd have the choice of either stripping the passenger cabin or removing it wholesale to be mated to a new chassis and used as a surface coach! Or perhaps covered with regolith and used as a construction shack in the field! Even here, we'd want to have as much as possible of the cabin and its original outfitting made of Lunar deficient materials for gradual retrofitting replacement with local fabrications allowing the original materials eventually to be cannibalized.

Best of all, the fuel expended in getting all this accessory equipment to the Moon gets billed as part of the passenger fare or cargo freight whether any of this stuff is removed or not. So IF we designed the craft and its outfitting for this kind of wholesale reoutfitting each trip, using “knock-down” assembly techniques to make the job a breeze, the settlement can get all this “loot” virtually for free.

If you think about it, the whole concept of Reassign-ability absolutely shatters up till now universally accepted fuel to payload ratios. Potentially, everything except fuel becomes payload. And that changes the economics of opening the space frontier quite independently of whether or how soon or how much we realize cheaper access to Earth orbit.

### **Earthside Entrepreneurial Opportunities**

Formulating and fabricating items out of elements scarce on the Moon instead of those abundant there may or may not lead to terrestrial applications. That depends largely upon entrepreneurial imagination and market testing. Making tare items (containers and packaging etc.) of alternate materials should certainly lead to marketable products for consumers who are becoming increasingly sensitive to the environmental impact of everything they use. The idea of making things to be reassigned and/or cannibalized is sure to have applications both in the consumer products field and in the continued opening of terrestrial frontiers like Antarctica. Imagination is the only limit.

### **The Bottom Line**

To a lunar settlement, every pound or kilogram of imports or co-imports “along for the ride” made of elements economically producible on site “costs” a pound or kilogram of dearly needed “lunar deficiencies”, hard-to-do-without elements not locally producible, that could have been imported instead for the same import bucks. This is the kind of opportunity that a for-profit operation seeking to open the frontier would eagerly seize upon. It is also the kind of opportunity that deficit-jaded government operations routinely shrug off.

Taking the pains to reformulate these potentially free “stowaway” imports will slowly but inexorably build up substantial endowments on the settlement site that will go a long way towards removing the severe industrial handicaps under which the pioneers must otherwise operate – and all virtually free of real added cost. The fuel expended to get these items there, reformulated or not, is in effect a hidden import tax. As this tax must be paid anyway, it'd be unforgivable not to use the bootstrap opportunities involved. MMM



COSMOTIVE, INC. By Peter Kokh

### Fuels Division

Most brainstormed Lunar Development Scenarios call for earliest possible **Oxygen** production. We need oxygen to make water, for atmosphere and biosphere, and as oxidizer for rocket fuel. The intent here is a) first to reduce the cost of return crew and cargo trips to orbit and back to Earth, and then b) to ship lunar oxygen to low Earth orbit cryogenic refueling depots to lower the cost of further Moon-bound supply and resupply shipments from Earth, and finally c) to reduce the cost of expeditions to Mars and the asteroids.

While in water vapor, the combustion product of LOX and LH<sub>2</sub>, there is an 8:1 mix by weight, the actual mix going in is a hydrogen enriched 6:1. So lunar oxygen cuts the cost of 6/7th of the fuel mass. How can we do better?

An early and still often mentioned proposal is to use the hydrogen imported to the Moon to best advantage by first combining it with local silicon to make liquid **Silane** SiH<sub>4</sub> (a nominal analog of methane) and use that instead of hydrogen as fuel. While Silane is less potent than LH<sub>2</sub>, its use promises to reduce the freight bill of sustaining the outpost or settlement by a significant enough percentage to be worth pursuing once the demand justifies the cost of required capital equipment. In the Silane family are other potential liquid fuels, some of which should work even better, such as Si<sub>2</sub>H<sub>8</sub>.

Are there other potential totally indigenous lunar fuel combinations? In theory, yes! Oxygen has a high enough affinity for Iron, Aluminum, Calcium, and Magnesium (all rather abundant in lunar soils) to make good fuel combinations — on paper. Most discussed are Iron, which exists in handy abundance as powdered fines, and Aluminum, which, alloyed with 25% Calcium, makes a very friable easily powdered alloy.

However, we have yet to engineer a [chemical] rocket engine that can use such fuels. It's not a matter of engineering difficulty so much as the fact of life that in none of NASA's scenarios is there more than token lunar development. Thus there is not enough perceived need to justify the expense of R&D on such fuel combinations and the motors to burn them.

Those of us interested in seeing tumble the "NASA Wall" that prevents opening the space frontier to the general public (as opposed to token elite proxies for voyeuristic gratification) need to find and/or encourage entrepreneurial development of such transportation modes. Even if cheap access to space (CATS) is realized in the Delta Clipper program, the cost of shipment of goods into and out of the lunar gravity well will remain higher than it needs to be without the development of refueling options using "all lunar" fuels.

Once all the fuel needed to refuel a rocket bound for the Moon in low Earth orbit is produced locally on the Moon, the settlement's net bill for shipping and freight costs for needed imports the rest of the way from LEO to the Moon becomes moot. Not only will it be cheaper to import, but the fuel overhead cost of exporting will fall, increasing whatever competitive advantages that might already exist.

### Hold & Hull Division

As we've hinted, space pioneers ought not to rest content with diversification of production for export and with maximizing market opportunities. They can improve their competitive position by paying themselves for the freight bill of both imports and exports. Using lunar-sourced fuels at every opportunity is just one part of this effort. Locally supplying as much as possible of the containers and vehicles used in import and export shipments will boost savings even further on items already competitive, and may make the competitive difference for other items marginally short of being so.

The idea of a Lunar Frontier Aerospace Industry will elicit gaffs of laughter from many. But recall the MUS/cle paradigm for lunar industrialization that we've previously recommended. [MMM # 18 SEP

'88 pp. 3-4 "Lunar Industrial MUS/cle", and MMM # 65 MAY '93 pp. 7-8 "The Fast Road to Lunar Industrial MUS/cle and the Substitution Game"]. It is an "appropriate" lunar aerospace industry we are advocating.

Lunar industry should not concern itself with those complex, lightweight, and electronic ("cle") components which require a sophisticated industrial base to manufacture and which can be made on, and shipped from Earth relatively cheaply. Instead, frontier industrialists should concentrate on the more massive, unitary, and simple ("MUS") components. These are items that would otherwise cost a lot to import because of their aggregate weight, but which can easily enough be made in the settlement's startup industrial shops.

What is needed is a glass composites industry to start off production of tanks, body panels, spars and truss frame members, etc. Second generation industries using local iron, magnesium, titanium, and aluminum can expand the selection of aerospace products it is possible to fabricate locally.

We are talking about:

- ✓ **fuel tanks** both for depots and on ship,
- ✓ unpressurized **cargo holds**
- ✓ pressurized **crew compartment hulls**
- ✓ **aerobrake shields**
- ✓ **truss frame members**, etc.
- ✓ many other lesser parts that "all add up".

A Lunar aerospace manufacturer could make these components and then assemble them with imported "works" cartridges (e.g. electronics such as navigation, control, and communications consoles, engines etc.) and slip-in harnesses etc. to make complete ready-to-fly craft.

Going one step further, here is no reason why Lunar industry could not make drone **Lifting body hulls** so that exports to Earth's surface could fly nonstop from the Lunar surface aboard one way space craft the majority of whose mass was manufactured there. There is precedent aplenty for such divided manufacturing. Martin Marietta, for example, maker of the Titan rocket, only makes the rocket casings, and then mates them with engines and other components made by other firms like Rocket-dyne.

And as for more sophisticated space hardware? Why couldn't lunar owned & operated **salvage companies** retrieve derelict satellites and other largely intact space hardware for rebuilding in lunar shops, and eventual reflight and reassignment?. Why accept preconceived limits? MMM

## MMM #81 - December 1994

[Designing "Amphibious" Spacecraft Cabins to be transformed into Lunar Surface Craft]

### **TOADMOBILE CONVERSIONS**

By Peter Kokh

The problem is easily stated. Our first returning crews will need surface transport on the Moon immediately. Further, as the base expands and undertakes more activities, its surface transport requirements will grow and diversify rather quickly. Yet the day when such vehicles can be manufactured on site is far off. How do we get these craft to the lunar outpost site in the most economically sensible way?

**Consider that a lunar surface craft is still a spacecraft.**

It has to have a vacuum-worthy pressurized hull, have thermal control, micrometeorite protection, full radio communications, power reserves, etc. etc. The lunar surface, after all, unlike that of our home planet, is an interface with vacuous space itself. It is not the pressurized cabin that differs, but the motive chassis. In the one case we need rocket thrust propulsion, in the other we need wheels or legs. At least the cabins can make the trip to the Moon carrying people.

One can enter this in the books in either of two ways: (a) the fares of Moonbound passengers pays the freight bill on the transport cabin; (b) the passengers ride free or at reduced cost, almost as stowaways, the bill being paid by the agent ordering the vehicle for lunar surface use.

Thus at least some Earth–Moon passenger cabins will in fact be built for “amphibious reassignment”. Those whose design is maximized for freight hauling, or for equipment–laden field trips with minimal crews, are likely to be reassigned upon completion of their first outbound trip. Those made as passenger ferries may serve in this capacity for a good number of round trips, and then “retired” to surface duty as a “coach” after being mated to new ground–chassis in a final overhaul just before its last trip out from Earth orbit.

How many trips would such a cabin make before being reassigned to the surface? This would vary as the average crew stay time lengthens and as the number of people coming out to the Moon each month grows in ratio to the number returning home. For example, instead of each ferry returning to Earth at 75% capacity, every fourth ferry landing could be a final one, with the cabin wheeling off into the lunar Sunset, while the other three returning home full. Or in other words each ferry would make three round trips, followed by a final one way trip, to drive happily ever after over the moonscapes.

Obviously, this process can either be allowed to just “happen” or it can demonstrate a great deal of forethought. For example, ferry craft can be designed to optimize their usefulness as lunar surface coaches, at least where doing so would not compromise their safe functioning as a ferry en route.

The same double service design principles can be applied to pressurized holds as well as to crew and ferry cabins. We will need such holds and ready–to–outfit hulls on the Moon as well as en route.

Other lunar surface needs will be rather specialized and make for less than ideal ferries. Yet they need not make the journey out empty. Perhaps cabin importer and passenger(s) can split the savings. Beside mining crew, road–building crew, inter–settlement, and spaceport coaches, say in the 20–50 seat capacity range, we will need mixed passenger/freight vehicles and trucking rig cabins meant for one or two people, crane cabins, cabins on regolith moving equipment, etc.

But we will also need cabins that are towed to a site and semi–permanently parked as construction shacks, film–making headquarters, prospector camps, etc. Indeed, such sedentary usages may account for a large part of the demand.

**Space craft production without forethought to their eventual longer term after-careers would be foolish, and work to hamper and drag down the growth of any outpost or settlement.**

Clearly, there is the need for a great deal of preplanning if surface needs are to be met in a “just-in-time” fashion.

Cf. MMM # 48, SEP ‘91 pp. 4–6. “Hostels: Visiting Vehicle” [included in MMM Classics #5] and online at: [http://www.lunar-reclamation.org/papers/hostels\\_paper1.htm](http://www.lunar-reclamation.org/papers/hostels_paper1.htm) 

## MMM #88 – September 1995

[This article addresses the limitations built into our first Lunar Excursion Module, as a guide to what design standards a 2nd generation “LEM” should meet if we are going to go beyond Apollo.]

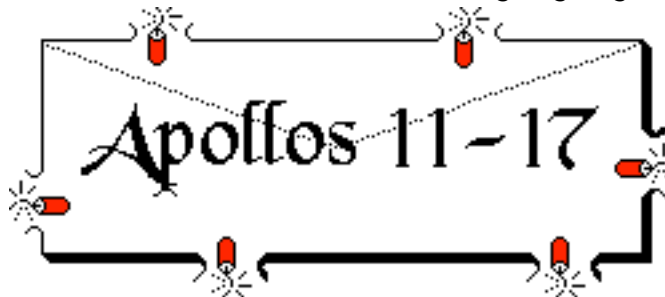

### I. Bursting Apollo’s “Envelope”

By Peter Kokh

Apollo was without precedent. For scouts of Earth to break free from their womb planet and set foot on what had always been an unreachable celestial sphere was a clean break with all that had gone before. It electrified civilization for a moment. Yet for all these nine manned missions to the Moon accomplished, six of them landing, so many really basic things were left undone that roundly shattering that precedent will be easy. We mean no disrespect! But, yes, easy.

=> Twelve men set foot on the Moon. Yet none of them slept in a bed there. The LEMs had only hammock-slings. All twelve walked in one sixth gravity, but only with cumbersome pack-laden pressure suits – the pressurized LEM “cage” was scarcely big enough to pace back and forth in place. So no one experienced what it is like to walk in lunar gravity, not really.

=> All the missions were [lunar] morning ones. No one experienced a lunar sunset, a lunar night, a lunar dawn. We never even hung around into local afternoon.

=> We ate and slept in our station wagon, not even pitching a tent. In effect we just picnicked there. Since our vehicle was our shelter, we took it with us when we left, and there is no camp, no cottage, to which we might return. We never visited any site more than once. We left no “building” on the Moon, not bringing any with us, not erecting any.

=> We never stayed long enough to plant, or grow, much less to harvest. Even the science we did was just field work collection stuff. We brought along no lab. Nor did we play much. Sure we romped around in our suits, hit a golf ball, and playfully rigged our flags so they looked like they were flapping in some vacuous breeze. Playful, yes. Play, no.

=> We were there, that’s all. Like Kilroy. And then we were gone, and are gone still. We took samples from which to learn what the Moon is made of, but which have since been guarded so jealously by an intermediating priestly class “lest we never return” that we have not been free to learn from these samples what we might **make out of** what the Moon is made of, as if to guarantee that we would never find the confidence to return on a live-off-the-land basis.

=> We left stuff too – more than footprints, stuff that could someday be prized pioneer relics in local lunar museums. But to date, more than two decades later, these leavings only remind us of our failure to build upon what we had done, to stand tall on the shoulders of our heroes. The “revolution in history” has been downgraded to an anomaly, a distraction.

### **A new beginning**

So much of both the technology and the expertise that carried the Apollo program on to its brilliant successes has been lost, dismantled, even deliberately destroyed, that we can no longer just repeat these humble sorties. They cannot even be called beginnings since they have been robbed of the chance to lead to something more that follows.

Not quite. We have the knowledge, the record, and some teasing results of matter-starved experiments that suggest what we might be able to do with lunar regolith – make oxygen, iron and steel, aluminum and titanium, cast basalt and ceramic objects, sinter blocks and concrete, glass and glass composites – in effect fuel, air, water, tankage, vehicle and habitat parts, furniture and furnishings. We could even do out-of-fashion soil-based farming. Bring back with us but talented people, tools, and seeds, and we might just make a go of it.

With the total absence of political will, any return will have to be humble, laying down a few foundation stones at a time. Our first beachhead can only become permanent in time. But even if the first crew returns home for some while before the next is sent, it will have been easy to shatter all Apollo’s achievements with the first mission.

- (1) We leave a habitat structure on the Moon, perhaps returning to an awaiting orbiting ferry (serving a function like Apollo’s command modules) ascending on a cabinless platform (not unlike the Apollo rover) protected just by space suits.
- (2) Our habitat has room enough to walk around, and to sleep horizontally in cots or on air mattresses, and is big enough to boast both private and common room areas.
- (3) We “dig in” our shelter, placing it under a soil-shielded canopy or heaping soil directly upon it to make longer stays possible without high accumulative radiation exposure. Now we have a camp, a cabin, a cottage on the Moon, a permanent structure to come back to, and from which to expand in due course, as we learn to do so step by step, using primarily building materials made on location.
- (4) We leave an electronic beacon so that follow on missions can make instrumented landings at the same spot.

### **Then What?**

- (5) We stay not only all “day” but past sunset, outlast the long two week night, and start a new lunar “day” before going home. This will be quite a feat, not unlike the first “overwintering” on Antarctica. Even with a nuke source for energy, we’ll have less power than during the dayspan when we can tap sunlight as well. We’ll have to switch from energy-intensive tasks during dayspan to manpower-



intensive energy–light tasks during nightspan, establishing a lunar rhythm that may forever after give life on the Moon much of its characteristic flavor. In the process, we'll have to have in place an advanced, possibly bio–assisted, life support system regenerating our air and water supplies. We'll also have had to have demonstrated, probably in an unmanned dry run, thermal stability of the station through the nightspan. Shielding will help here too, minimizing exposure to the heat sink of space.

- (6) If we stay six weeks or more, we can plant some salad stuffs and bring them to harvest. The first feat for lunar farming and agriculture to come.
- (7) We might try some brief sorties outside the station during nightspan. That means headlights, that means lubricants that can take the cold – or magnetic bearings. That means heated spacesuits or an infrared radiating cage or a minimal cabin.
- (8) We bring along pilot oxygen production equipment, demonstration iron fine and gas scavenging equipment, a solar furnace to experiment with cast basalt, ceramics firings, iron sintering, and glass production. We have brought along some basic tools for fabricating sample test objects.
- (9) There is a parallel Earthside “Moon station” in which problems on the Moon can be addressed in close simulation, and in which terrestrial brainstormers can proactively outline suggested new experimental exploits for the lunar crew.

[snip rest of article]

## MMM #91 – December 1995

### From the MMM Dictionary Entry — “Space Activist”

“Anyone who uses his or her talents to the best of his or her ability to promote and hasten the realization of an open space frontier.” This means anything! –

**as a writer of general or textbook nonfiction, or of hard science fiction, screen plays, poetry, even “filk” songs; as an editor, publisher, bookseller; as a speaker or event organizer or exhibitor; as a teacher or curriculum planner; as an artist or model maker; as an actor, director, or producer; as a merchant; as an engineer, chemist, researcher in biospherics or experimental agriculture or as a space architect; as an entrepreneur or venture capitalist; as a lawyer, “et cetera”**

All these roles, and **many more faceless support tasks**, are the essence of either of public outreach in depth, or of laying concrete foundations, or both. There are far more menu options than those amongst us concerned only with political action would have us believe.

**We are more than letter and check writers, more than phone dialers. We are the people who would move off planet out onto the space frontier. We do it best by each doing our own thing as well as we can, not by doing solely what someone else would have us do to pursue some smaller vision.**

Entry — “Open” Space Frontier — “A future in which people of all walks of life have access to, and live, work, and play in various settings off Earth.”

The NSS Mission Statement reads: “to promote change in social, technical, economic, and political conditions to advance the day when people will live and work in space, through public education, political and local chapter activism, and the publication of the bimonthly Ad Astra Magazine.”

The NSS “Mission–centered goal: by 2010: human settlement in space with 25 people, launch costs under \$50/lb to orbit, and space–generated revenues of \$60 billion.”

This reflects crucial influence of former L5 Society members who chose to stay on board at the time of the L5 – National Space Institute merger in 1987 which created NSS.

As NSS seems overtly preoccupied with reacting to one crisis after another in which political pressures would erode the current socialized space program (in the direction of no program at all) it might seem to the unfamiliar outside observer that NSS’ sole purpose is to promote the continuance of the government’s “closed” frontier policy (“astronauts only, government outposts only, scientific activities only)” in effect since the dawn of the Space Age with Sputnik in 1957. The NSS Board, however, is firmly on record in support of an “open” frontier. Given its preoccupation, however, it is clear that the rest of us must work that much harder at strategies that Open the Frontier — outside NSS, if need be.

Entry — **“Commercial Space”** – “any for-profit endeavor or enterprise which increases the amount, scope, feasibility, and/or sustainable economic viability of robotic and/or human presence in Earth orbit and beyond.”

One might get the idea from many space activists that commercial space means private launch companies and small satellite manufacturers – only! Even if this is qualified with an “at this stage of the game” this short list betrays a troubling lack of imagination, coming as it does, from people who say they want to live somewhere other than on Earth!

While it may be easier, and safer, to restrict one’s ambitions to the “toy space” of microsats and small launchers, our goal is to create a self-sustaining human economy beyond Earth’s atmosphere. This clearly requires **commercial entry into man-rated rockets and habitat hardware**. This has already begun. The for-profit SpaceHab shuttle payload bay module is already a reality, but has faced a rocky road.

Early plans for commercial tourist modules were ill-fated because they depended either on paper study spacecraft, or upon the government owned shuttle. Any effort to piggyback commercial for-profit activity on profit-be-damned agency programs is at the mercy of political pressures and bureaucratic procedures — hardly a place to put dearly acquired capital.

Many put all their hopes on the X-33 program. But the dream of **Cheap Access** from NASA seems troublingly self-deceptive. Meanwhile, would-be commercial players stall.

We clearly need **commercial manned access** to space. Yet the very presence of the shuttle system works in a highly preemptive manner to prevent such access from materializing. What is needed is to tie in with a **commercial manned destination**: a commercial space station. With the adoption for the International Space Station Alpha of the high inclination orbit favored by the Russians, there has never been more reason than now for an alternative, a commercial station-depot in a low inclination orbit vastly superior as a staging and refueling place for deep space missions. Alpha would serve Moon and Mars missions at a severe handicap in comparison. There will also be need in orbit for more lab space at commercial disposal than ISSA can or will provide.

We also need to dust off the **“Space Cartage Act”** proposed many years ago whereby anything once in orbit and without its own motive power, could be moved to another space location or orbit only by a commercial vehicle.

**Yet** there is another kind of entrepreneurial activity which has the potential to accelerate the realization of an open space frontier. It is not at the mercy of bureaucratic, administrative, or congressional whim. Why not? Simply because it is a path that does not threaten powerful vested interests. We are talking about **“spin up” research & development**.

“Spin up” works like this. The entrepreneur considers the many and varied technologies that will someday be needed on the space frontier. Next he/she considers what profitable terrestrial applications there may be for each of these. There follows a business plan, and ultimately a for-profit terrestrial enterprise which has the happy effect of pre-developing and debugging and putting “on the shelf” a technology which will one day help open the frontier – sooner and at less cost.

## **The Essence of the Frontier: “Readiness to Reinvent Everything” (including Space Transportation)**

**MMM #94 – April 1996**

# **Lagrange Point Staging for Lunar and Planetary Flight**

LAGRANGE POINT STAGING FOR LUNAR AND PLANETARY FLIGHT By Larry Jay Friesen

[Larry Jay Friesen is a physicist by education, and has worked for a number of years with various aerospace contractors at Johnson Space Center. He has worked in the area of orbital dynamics and currently is with the Hypervelocity Impact Laboratory. Larry is an Artemis Society member, serving on the Mission Design Technical Committee.]

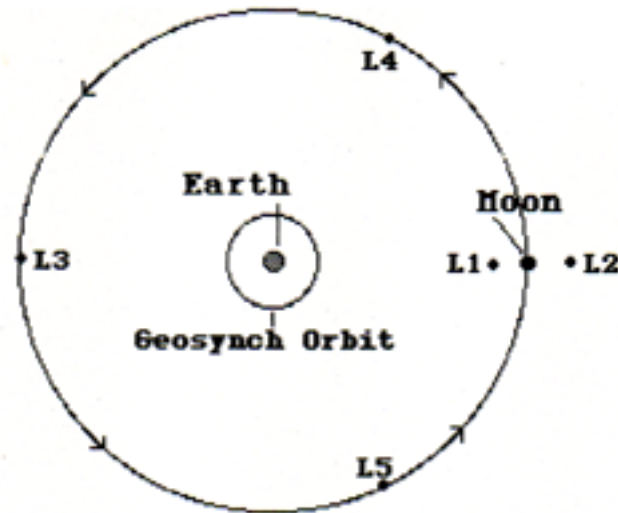

Figure 1 Orbital locations in the Earth-Moon neighborhood, showing Lagrange points.

## Introduction

I would like to propose for consideration by would-be Lunar pioneers, a location for staging traffic between Earth and the Moon – once a lunar base has been established. The same orbital location, surprisingly enough, could make an excellent place for staging interplanetary space flights.

I am referring to the L1 Lagrange point in the Earth-Moon system. I am not the first to consider this orbit as a use-ful place for a base. Keaton discussed Lagrange point bases as possible staging lo-cations at the first Lunar Base Symposium in 1984 [1]. Farquhar [2] had recommended a Lagrange-point station as an element of an Earth-Moon transportation system in 1972, although he preferred the L2 point beyond the Moon.

L1 is an orbit between Earth and the Moon, located approximately 58,000 km [36,000 mi] this side of the Moon. An object placed there with the right initial velocity would orbit Earth in step with the Moon, remaining along the Earth-Moon line throughout each lunar month. The actual orbit selected for such a base may turn out to be not exactly at the L1 point, but in what Farquhar calls a “halo orbit” around it, such as he suggested for his proposed L2 base [2]. However, details of orbits are subjects for further study, and the L1 point proper will do for the present discussion.

The most efficient way to reach L1 from low Earth orbit (LEO) (and to return to LEO from L1 is via a lunar swingby trajectory, in which the spacecraft does a figure 8 around the Moon, as the Apollo capsules did, and performs a course adjustment maneuver (“burn”) to send it to L1, and then a final burn at L1 to change course and speed to the L1 orbit.

When people think of putting staging bases for lunar missions near the Moon, they are often thinking of bases in low lunar orbit (LLO), a few tens to a few hundreds of kilometers above the lunar surface. Why do I want to put a space station so far away?

There are advantages for having an L1 space station over an LLO base that apply to Earth-Moon traffic. There are others that pertain to manned interplanetary flights.

### L1 Advantages for Lunar Base Support

To begin with, an L1 base offers great adaptability for supporting lunar surface operations. From L1, it is possible to launch at any time to any location on the lunar surface for a similar delta-velocity (DV) and flight time interval. For those not familiar with the term, DV [“delta-V”] is the sum of the veloc-ity changes for all the maneuvers a spacecraft must perform in order to accomplish a given mission, or a major portion of a mission. It allows planners to estimate propellant requirements for the mission.

Propellant requirements tend to go up much faster than DV. For example, doubling DV for a mission would more than double the propellant requirements.

Mission DV from L1 to the lunar surface is approximately 2.76 km per second, a little over lunar escape velocity, (unless you're in a hurry, in which case it is more), and the flight time is 3 to 4 days (again, unless you're in a hurry). Likewise, you can launch from any place on the lunar surface to the L1 base at any time, for the same DV and flight time.

But an LLO base circles the Moon every 2 hours or so, so it shouldn't take more than about 3 hours at most to get down, and the DV cost is only lunar orbital velocity, or 1.7 km/sec. So where's your advantage?

That 3-hour time span and 1.7 km/sec. DV represent the best case. That best case occurs if the lunar surface base is in the orbit plane of the orbiting station. Only two situations can guarantee that the surface base will always be in space station's orbit plane. One of those situations is if the surface base is on the lunar equator and the space station is in the Moon's equatorial plane. The other is if the space station is in lunar polar orbit, and the surface base is located at either the north or south pole of the Moon.

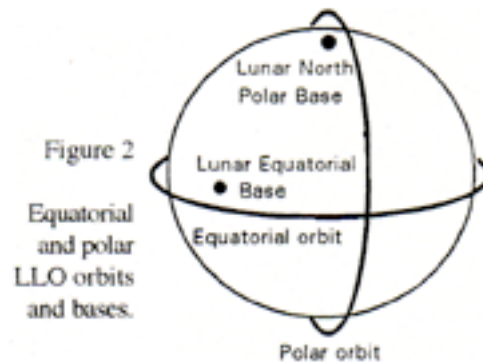

But what if we want more flexibility in our surface base location? Or what if we want to support several surface bases at different locations on the Moon? The one type of orbit which can overfly every spot on the Moon is a lunar polar orbit. Problem is, you have to wait until the Moon rotates under you, to reach any given spot on the lunar surface. If you are lucky, the surface base may be in your orbit plane now. Otherwise, it could mean a wait of anything up to 14 days.

Suppose there is some emergency, and you have to get a spaceship down to the surface, or from the surface up to the space station, as quickly as possible, and you can't afford to wait 14 days? Then you will have to do a plane change before descending (or after ascending). Orbit plane changes are very expensive in DV, and thus in propellant. In the worst case, if the surface base is 90° away from the current station orbit plane, the ship will have to do a 2.4 km/sec. burn to change planes and then pay the 1.7 km/sec price to reach the surface, for a total DV of 4.1 km/sec.

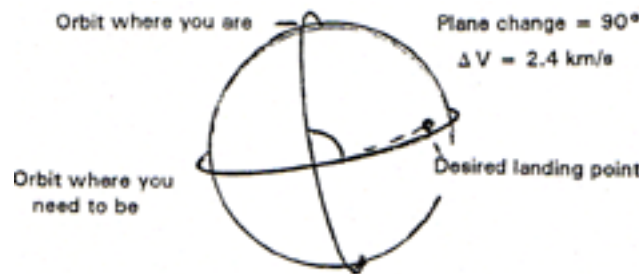

Figure 3. 90° orbit plane change and descent from LLO.

So we see that in the best case for a LLO base, it beats the L1 base for wait time and DV to and from the lunar surface. But in the LLO base's worst case, the L1 base wins. And we recall that the L1 base gives us a much more predictable, and at the same time much more flexible, mission scenario. Launch windows are essentially unlimited.

Another comparison of interest is station keeping. Space stations in either orbit will have to perform propulsive maneuvers from time to time to maintain their required orbits, and will require propellant to be supplied for that purpose. A station in LLO will have its orbit perturbed by the gravitational

tugs of Earth and the Sun. The eccentricity of its orbit will be changed over time from the initially circular orbit to one more elliptical. The perilune (point nearest to the Moon) will be lowered and the apolune (farthest point) will be raised. L1 is not one of the stable Lagrange points. The station will eventually begin to drift away from that position if its orbit is not corrected.

According to Farquhar's estimates, the DV requirements for such station keeping are rather similar for both LLO and L1 bases: on the order of 120 meters/second/year. The consequences of failing to perform the station keeping maneuvers, however, are not. For orbital altitudes typically quoted for LLO studies, 100–200 kilometers above the lunar surface, perilune would be lowered so much that the station would crash onto the surface of the Moon in a matter of months. An L1 station would drift away from the L1 orbit, but would most likely remain somewhere in the Earth–Moon vicinity. This gives a much better chance for rescuing the crew, and perhaps even of inserting the station back into the desired orbit.

L1 also appears to offer more advantage from lunar derived propellant than LLO. As the companion article to be published in next month's MMM discusses, transportation costs for supporting a lunar base can be reduced if at least part of the propellant for the spacecraft can be produced on the Moon. It will be a lot easier if we have gas stations at both ends of the run.

It has been widely publicized that oxygen can be extracted from lunar rock both for breathing and for use as propellant. Aluminum plus oxygen, for example, makes a decent rocket propellant combination. They may also be combined with hydrogen, as described in the companion article, for a high performance tri-propellant combination. If we are using lunar-derived propellants for the ships traveling between our space station and the lunar surface, making L1 rather than LLO the transfer point uses lunar propellant for a greater portion of the Earth-to-lunar surface voyage, and thus requires less propellant be lifted from Earth.

One reason why I prefer L1 over L2 as a station location is that I expect early lunar bases to be on the near side of the Moon, and L1 could supply a great deal of support for lunar surface operations. For one thing, it could act as a communication relay for almost the entire lunar nearside, linking bases to each other (if there are more than one) and to exploring expeditions that may be on extended traverses hundreds or thousands of kilometers from any base.

Just as an L1 space station could relay communications, so it could relay power. If a solar power satellite were included in its design, it could beam power to nearside surface bases, greatly reducing their power storage requirements. A lunar surface base (except at the lunar poles) is in darkness half the time, which will require it either to have energy storage capacity for two weeks at a time, or to use nuclear power. A station in L1 orbit is in shadow no more than a few hours at a stretch, a couple of times a year, during lunar eclipses [at other full moon situations, L1 along with the Moon will either be above or below the Earth's shadow].

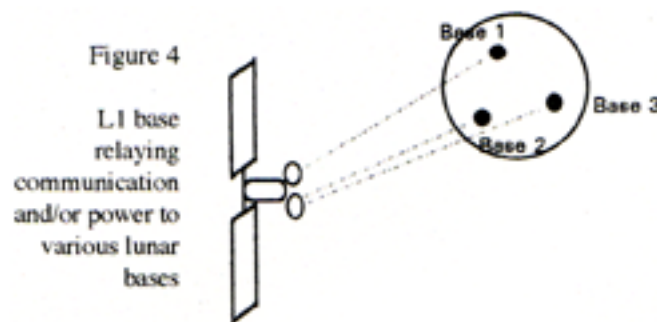

**L1 Advantages for Interplanetary Flight**

Figure 5  
Triple thrust  
departure  
from L1 to  
interplanetary  
space

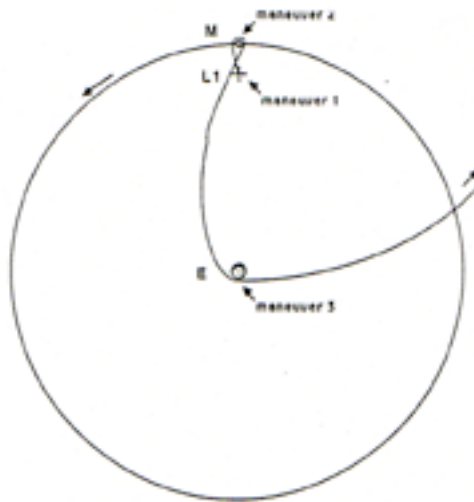

In addition to being an excellent support base for lunar surface operations, an L1 station would have significant advantages as a base from which to launch and recover human-crewed interplanetary vehicles. These advantages include:

- (1) **saving large amounts of propellant** by using Earth swingby or “gravity slingshot” trajectories to launch and recover the vehicles and
- (2) **use of lunar-derived propellants** as a majority of the propellant mass to fuel the craft.

A gravity slingshot trajectory begins with a reverse of the lunar swingby used to reach L1 from LEO. A spacecraft departs L1 with just the right velocity change to swing it past the Moon as though it were returning to Earth. It passes close to Earth, but instead of breaking into LEO, it accelerates, adding enough velocity to hurl it onto its interplanetary trajectory. It is already moving at nearly Earth escape velocity before the burn, having gained most of that velocity from gravitational potential energy in its fall from the Moon toward Earth. Because of the spacecraft’s already high speed, the burn DV does not have to be large. Figure 5 illustrates such a “triple thrust” slingshot departure from L1 for an interplanetary trajectory. It would not be efficient to bypass the slingshot maneuver and launch from L1 directly into an interplanetary trajectory. That would fail to take advantage of the kinetic energy gained from falling toward Earth and would take much more propellant.

Table 1 shows a comparison of DV requirements for an L1 launch vs. a LEO launch for a Mars mission. The L1 launch Maneuver 1 and Maneuver 2 DV figures are based on Farquhar’s figures for reaching L2 [2] and may need checking. However, they are unlikely to be in error by as much as a factor of 2. We see that launching from L1 saves on the order of 2.5 kilometers per second of DV over a launching from LEO for an outbound trip to Mars. The return trip requires the same DV amounts as the outbound trip to reach either L1 or LEO, so savings will double.

Table 1. Mars Mission DV Requirements, L1 vs. LEO launch

<b>L1 launch</b>		km/sec
At L1 <sup>1</sup> :	Initiate Lunar swingby =	~ 0.15
At perilune <sup>2</sup> :	Switch to Earth flyby =	~ 0.20
At perigee <sup>3</sup> :	Initiate Mars transfer =	0.79
	Total near-Earth DV =	1.14
At Mars	Entry low Mars Orbit =	2.08
	TOTAL one way DV =	<b>3.22</b>
<b>LEO Launch</b>		
At LEO:	Initiate Mars transfer =	3.65
	Total near Earth DV =	3.65
At Mars	Entry low Mars orbit =	2.08
	TOTAL one way DV =	<b>5.73</b>
<b>DV saved</b>	<b>by launching from L1</b>	<b>= 2.51</b>

<sup>1</sup>: maneuver 1 of Figure 5; <sup>2</sup>: maneuver 2; <sup>3</sup>: maneuver 3.

One study I was involved with at Lockheed assumed a three-stage Mars exploration ship launched from LEO [3]. When we considered launching from L1, we found we could omit the entire first stage.

Part of the DV for the return trip could be accomplished by aerobraking in Earth's atmosphere, rather than by a propulsive burn. But here, too, return to L1 would have an advantage over return to LEO. The perigee maneuver at Earth would only have to cut the velocity by 0.79 km/sec to put the spacecraft on a trajectory to L1. This is a lot less than the 3.65 km/sec needed to brake into LEO. That means a lot less kinetic energy converted to heat, so the aerobrake could probably be made much smaller and lighter (which in turn means less propellant to haul it to Mars and back).

Similar DV and propellant savings will apply to any interplanetary flights launched from L1 (including to asteroids). The reason is that most of the mass for an interplanetary mission does not consist of people or payload. It consists of propellant ... and as we have already noted, propellant requirements for a mission increase much more rapidly than DV requirements.

But you may be saying to yourself, I still have to get my ship, crew, payload and propellant from Earth up to L1 to begin with. When you raise this question, you are on to an important point. The scheme of using L1 as Earth's interplanetary port only makes sense if the ships can use lunar derived propellant, and if we plan on repeated interplanetary voyages. If we plan on making only one Mars mission with people on board, or two or three, then we might as well assemble and fuel them in LEO and forget L1 basing.

However, we have already discussed some possibilities for getting propellant from lunar sources. Any propellant made at the Moon will not have to be brought up from Earth. If the interplanetary ships use hydrogen/oxygen propellant, lunar oxygen could make up 5/6ths of the propellant mass (using Shuttle combustion ratios). That's quite a saving.

We have also discussed lunar aluminum as propellant for lunar landing vehicles and possibly for Earth/Moon ferries. Aluminum and oxygen alone may not have the specific impulse designers would want for a Mars ship. (Specific impulse is a performance measure for rockets somewhat analogous to miles per gallon. It is often given in units of seconds, meaning the number of seconds that one pound of propellant could produce one pound of thrust, before it is consumed.) However, as discussed in more detail in the sequel companion paper, a concept for an aluminum/hydrogen/oxygen tripropellant combination has been put forth by Andrew Hall Cutler [4]. At an H:O:Al mass ratio of 1:3:3, such an engine is expected to have a specific impulse exceeding 400 seconds – only slightly poorer than hydrogen and oxygen alone. An engine of this type might be worth considering for interplanetary vessels as well as for vessels on the LEO-Moon run.

The second requirement for L1 launches to be advantageous is to have repeated interplanetary trips, and to return to L1 as well as start voyages there. That way, you build a ship once, and only once have to lift the structure from LEO to L1. For all subsequent voyages of that ship, you will only have to ferry people, payloads (the less massive elements of the [loaded] vehicle) and (maybe) propellant hydrogen from Earth. The major portion of the propellant (and the majority of the initial mass of the [loaded] ship) will be Moon-derived.

Establishment of an L1 space station to support both lunar surface operations and interplanetary voyages would offer significant advantages in flexibility and efficiency to each, and an opportunity to "kill two birds with one stone."LJF

#### References:

- [1] Keaton, Paul W. "A Moon Base/Mars Base Transportation Depot," Lunar Bases and Space Activities of the 21st Century, W.W. Mendell, ed., Lunar & Planetary Institute, Houston, (1985) pp. 141-154.
- [2] Farquhar, Robert W. "A Halo-Orbit Lunar Station," *Astronautics & Aeronautics*, (June, 1972), pp. 59-63.
- [3] Friesen, Larry Jay & Bridget Mintz Register. "Space Station Accommodations for Manned Lunar and Mars Initiatives," Lockheed Engineering and Sciences Co. for Advanced Projects Office, NASA-JSC Houston (1989).
- [4] Cutler, Andrew Hall. "Aluminum Fueled Space Engines for Economical Lunar Transportation." Lunar Bases and Space Activities of the 21st Century, W.W. Mendell, ed., Lunar and Planetary Institute, Houston, (1985) p. 61.

[Note: a space suit is a form of vehicle!]

## Spacesuit Aversion

### The quest for alternatives to a user-unfriendly interface

SPACESUIT AVERSION By Peter Kokh

#### Relevant Readings from Back Issues of MMM

MMM # 5 MAY '87, "M is for Middoors" – MMM # 49 SEP '91, p 4 "Visiting Amphibious Vehicle"

MMM # 53 MAR '92, pp 4-6 "Xity Plans" – MMM # 89 OCT '95, p 6 "Dock-Locks; Buppets"

**Bryce Walden**, Oregon Moonbase ([bwalden@aol.com](mailto:bwalden@aol.com)) writes:

"Sorry I don't have a firm attribution for this. It's a short note I took down while channel-hopping a couple of years ago. The speaker was an astronaut with some experience in a spacesuit, and he listed the "Five Worse Things About A Spacesuit:"

(1) You can't blow your nose. (2) You can't comb your hair. (3) You can't read your watch.

(4) You can't eat regular food. (5) You can't scratch an itch. (6) You can't light up a cigarette (added by Ed.)

I suspect that the first and last complaints will be the most irksome, but also that these are just the handy lightning rods for an overall discomfort with what must be even to the most adept and practiced, an unnatural way to interface with an admittedly hostile environment. For that is just what a space-suit is, an interface with vacuum, with temperature extremes, and with the slow micrometeorite rain. Against other dangers of the alien environment, like cosmic rays and solar flares, it offers almost no protection at all.

The real point is that existing suits (at least) are not easy to don or doff, are cumbersome to get around in, interfere with free natural motion, and make manipulation difficult and clumsy. Where different pressures and atmospheric mixes are used in the spacesuit than in the habitat or vehicle supporting the sortie, pre-breathing is necessary, adding patiently or impatiently wasted hours before and after the venture in which little useful or satisfying can be accomplished. Spacesuits add to, rather than diminish the degree of difficulty and exertion the called for activity would of itself entail.

Improvements are certainly possible. The constant volume hard suit would eliminate any pre-breathing requirement and, if, as we have suggested, entry to and egress from the suit were made from a turtle-shell life-support pack backed into a conformal docking port, the whole airlock ritual with its wasteful exhausting of precious habitat atmosphere in each cycling, could be engineered out of existence. [cf. MMM # 90, NOV '95, "Dust Control"]. NASA may not feel the need, but frontier pioneers will soon demand such a development.

But why use spacesuits at all?

(1) Vehicles can dock directly with other vehicles and with habitats or other pressurized facilities, allowing "shirt-sleeve" access from anywhere to anywhere else.

(2) At any given settlement or development site, all pressurized facilities will run more efficiently if they are inter-connected via pressurized passageways and streets – save where activity with some risk of cross contamination requires prudent isolation. And such interconnection will create a larger shared mini-biosphere with greater forgiveness and buffering.

If the outpost or settlement is wisely designed, much routine outside activity such as system maintenance, vehicle maintenance, replacing volatile tanks, etc. can be done under the protection of a radiation shielding canopy or ramada. This would allow lighter-weight suits, more comfortable to wear, easier to get around in, and easier to manipulate through – a more user friendly vacuum-work interface.

And for field work? The turtle back suits will disencumber crew vehicles of the more massive airlock apparatus. But personal one-man wheeled or walking vehicles with feed-back or virtual-reality-



operated manipulators (“buppets” for body puppet, after muppet for mitten puppet), will again allow shirtsleeve comfort and freedom of motion as well as less restrictive personal activity for the occupant/driver/wearer.

The motivation and incentive to develop such replacement hardware will be strongly felt among those engaged in longer tours of duty, and considering “reupping” for duty tour extensions. As the “outpost interface” begins to morph into a “settlement incubator,” the demand for such hardware will squelch all bean-counting objections.

Predictably, there will be those few who need to feed their macho “rugged outvacsmen” image. Singly, or in small groups, they will put on suits and go outside to do their thing, ride around on lunar Harley hogs, go mountain climbing or whatever. Maybe they will have annual rebel outvac picnics at which they can pretend they are feeding their helmeted faces with roasted ribs and buttered corn on the cob after doing the three-legged race and the raw egg toss. Perhaps they’ll promote an amendment to guarantee their right to bear spacesuits.

Seriously, there will be genuine and worthwhile activities providing both adventure and challenge and which do require a spacesuit — like exploring a lavatube complex. Lunar spelunkers are sure to become a proud and exclusive fraternity, luring many a young kid with wanderlust and dreams of becoming a famous discoverer.

And there will be daredevils too, who in spacesuits, may try to walk a tightrope across a rille without a net, or free wheel down a mountain slope (look ma, no brakes) in an effort to see if there is after all some lunar equivalent of a terminal velocity in vacuum, and if so just how high it might be.

For most Lunans, visitors or settlers, wearing a spacesuit will simply not be an acceptable *modus vivendi*. Any sense of novelty, for kids or newcomers, will quickly wear thin. Face it, the spacesuit, as much as we take it for granted, is a quaint uncomfortable activity restricting contraption doomed to become a Flintstone-like anachronism.

The space suit will always be part of lunar frontier lore. But the stubborn situations which demand its use will be fewer and fewer as time goes by. As a result, it will quickly fade from everyday lunar life. Perhaps every able bodied lunan will still put one on now and then. But the occasion will be the semiannual depressurization drill, much like our school days fire drills, or lifeboat drills the first day out on some ocean-going or spacefaring cruise ship. MMM

## MMM #99 – October 1996

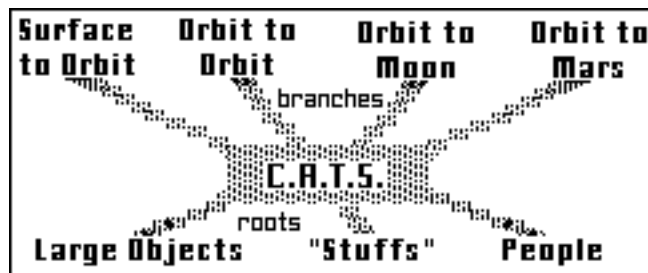

**The “Tree of Cheap Access” By Peter Kokh**

One thing almost everyone in the space activist community can agree on is the absolutely vital need to bring down drastically the cost of getting into space. But it is not commonly seen that this is not just one problem but several. Getting “**what**” into space? And just “**where in space**” are we talking about? The challenge is really multiplex. In this issue, we look at just some of the aspects.

### **Foreword**

Why should we think that it is only a question of guaranteeing that we find the best combination of features? Cheap Access To Space, CATS, is not a simple challenge with a single solution. It is a veritable tree of problems with both roots and branches spreading in different directions.

That the best CATS solution for large hardware payloads should by coincidence be the best CATS solutions for shipping materials to space that can be handled in any quantity, or that the best CATS solution for either should by some lucky quirk also be the best CATS solution for sending people, cabins—full of people, to orbit – that coincidence would be bizarre.

Heinlein pointed out that once you are in orbit you are half way to anywhere. With CATS. we will only have solved half our transportation problem.

We need Cheap Access from LEO to GEO, from either to the Moon, from Earth and the Moon to Mars. These are all different sets of challenges that are likely to have unique solutions.

If all that the push for Cheap Access achieves is to make it easier and cheaper to put communications satellites in orbit, we will have spent a lot of energy without doing a thing to open the real space frontier.

In this issue, we take a look at just some of the many challenges and just some of the possible solutions. We're sure there are more problems and more good strategies — our purpose is to stimulate thought and vaporize the current simplistic hysteria over something that is more important and far-reaching than most CATS champions have let themselves realize. In the end, CATS, the effort to insure **Ever cheaper access of everything we want to put in space to everywhere we want to go in space, will be an unending story.** PK

## Launching "Stuffs" to Orbit

LAUNCHING "STUFFS" TO ORBIT By Peter Kokh

By "stuffs" we mean commodities any which we may wish to ship to orbit or space destinations beyond in relatively high volume and over a long period of time, on a regular basis – which, however, can be shipped in any quantity. A lot of small pay-loads do the trick as well as a few big ones. We are talking about materials or substances, not hardware of set and indivisible fully assembled size. Some examples are water, hydrogen, oxygen, nitrogen, methane, ammonia, (volatiles of which the Moon seems to have a paltry endowment) other gases and liquids, powders, compacted pellets, computer chips and other micro-assemblies etc. In other words we are talking "pipeline" items, not "truckload cargoes," items which at their destination can be placed in tank/bin/silo farms, etc.

That such "stuffs" can be sent to orbit and beyond in piecemeal fashion, does not in itself warrant a conclusion that that is the most efficient way to ship them. It only means that pipeline analogs ought to be considered on their own merits with any high system development costs weighed against the accelerated amortization expected from high volume, individual stuff category by category, or collectively en masse.

The pipeline concept of regular supply, can be satisfied in several ways. Assembly line manufactured cheap small rockets launched often, is but one way. A high per unit time volume of traditional rockets, even if they are small, might add polluting exhaust gases to the atmosphere at a worrisome rate. The option would be to carry aloft only an orbit insertion/circularization engine to ignite well above the atmosphere. The initial boost to high altitude / high velocity suborbital trajectory would be made by an Earth-bound device such as a mag-lev mass driver or a gas gun.

Sandia National Laboratory in Albuquerque is one outfit investigating the possibility, and, of course, the military is very interested for the tactical applications it imagines.

A launch gun or launch track is only part of a working system, however, and promises to be a very capital-intensive, high upfront cost device. Further, it (either) could only accelerate projectiles and their hardy or hardened mini-payloads, at very high Gs (thousands!) into a forward position from which they could be, and would have to be, inserted into orbit by another part of the system.

The partnering part of the system could be a small onboard non-reused motor, or, in the case of commodities bound for geosynchronous orbit in a slot handy to an equatorially sited launch device, some kind of orbiting mass-catcher, anchored by the balance of its inertia and distance permanently overhead and downrange, ever poised to "catch" the steady stream, and somehow able to put the accumulated momentum from the catching process to good use in station-keeping. This can be arranged by putting the catcher at a slightly lower and normally faster altitude, with the steady momentum addition calculated to keep it at geosynchronous velocity all the same. I yield to the orbital mechanics experts.

Launch guns not on or very near to the equator would scatter their charges shotgun style to a whole equator–stradling range of crisscrossing orbits, unless launch was restricted to just one narrow window a day. That would make poor economic sense, so the incentives to find a genuinely equatorial site should be “insistent.”

Launch guns or tracks discharging at relatively high altitude above the thicker layers of atmosphere, would gain the further advantage duo of earning more altitude and velocity for the energy buck, while requiring less faring mass.

What about the pellet containers or capsules carrying the commodities? Three obvious possibilities are (1) Non–volatile self–contained solids might need no protective envelope, the minor ablation being deemed the cheaper option. (ice cubes as a container free way of shipping water would not seem very promising, however). (2) Empty the contents at destination and shipping the empty capsules or pellet projectiles back to Earth as cheap dunnage. And (3) make the container–farings of a material that is badly needed at the destination, in effect smuggling that material aloft as a stowaway co–shipment. Stainless steel, copper, brass, bronze, zinc, lead, platinum, gold, silver are just some of the choices. Effectively, this third method would produce maximum pipeline efficiency.

In the next article, we will talk about prime turf for such a pipelining facility. For this purpose, political, national, military and other usually primary considerations mean little. Location, location, location – as in real estate, for pipeline launch operations, location will be everything, the only thing.

Once assured volume of traffic warrants, for “stuffs” that can be pipelined, the Cheap Access to Space (CATS) answer(s) developed for large payloads and for personnel traffic may be an unsuitably expensive choice. However, until we have orbital or lunar facilities which will require relatively large reusable launch vehicles to bring up massive and bulky assemblies (habitat structure, energy production, material processing equipment – all in an earlier time frame), the demand for pipeline items will continue to be too low to justify the capital expense of a pipeline launcher. But it’s never too early to do the research on the tree of engineering options on which the eventual designers and builders of such a system will rely.

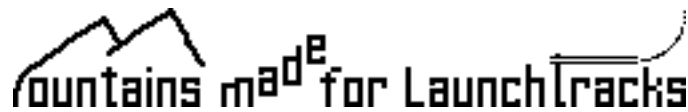

MOUNTAINS MADE FOR LAUNCH TRACKS By Peter Kokh

When the idea of using an Earth–captive virtual first stage e.g. a spaceship–carrying rocket–powered dolly accelerating along a track up the western slope of some convenient mountain, first was published, I’m not sure. I first saw the idea dramatically illustrated in the early 50s film “**When Worlds Collide.**” The sight of that large streamlined spaceship rocket–ing up that long slide and then out into space, bound for a planet around a star that would shortly swallow a vaporized Earth whole, is hard to forget. Men have dreamed of reaching space in this fashion for a long time. The ideal mountain, of course, is not on Earth at all, but on Mars, Pavonis Mons. But let’s take a look at what we have here on Earth.

We are all familiar with the advantages of launching Eastward from low latitudes, as close to the equator as possible, to get a boost from the Earth’s own angular momentum as it rotates on its axis. The maximum boost, at the equator, is 1,037.9 mph (1670.25 kph) = circumference of the Earth divided by 24 hours in the day. This boost diminishes as you move away from the equator to the north or south. The percentage of available boost at any latitude is given by the cosine of the latitude degree. For example, Cape Canaveral, Florida lies at 28° N. The cosine of 28° is 0.88295 which gives the percentage [88.29%] of the boost available at the equator, or 916 mph.

We are also, most of us, aware of the penalty, in the form of drag, incurred by launching through a thick atmosphere. If we could launch not only from on or near the equator, but from high altitude as well, launch efficiency would be maximized (translatable into higher altitude, larger payload, or both).

Early ‘50s science fiction writers almost universally imagined that White Sands, New Mexico would be the major gateway to space. Eventually NASA decided for political, military, and, Oh Yes, range safety reasons that this country’s major spaceport would be along Florida’s Atlantic coast. But Wernher Von Braun, the make–it–happen guru of modern spaceflight, actually had had a better idea when he

proposed that the World spaceport be located on a high mountain plateau in central New Guinea, 5° N. Von Braun, of course, was a multistage rocket man, and the idea of using an Earth-captive virtual first stage in the form of a mountain-slope climbing rocket sled dolly would have meant turning over an important part of launch operations to a separate team of scientists and contractors.

While the rocket sled idea remains “a path not chosen,” prime fodder for the writer of “what if” alternate histories, the idea is essentially sound. Without discussing the technical and engineering features and merits of such a space-hip launch track, let’s take a look at just what actual terrestrial mountains might make the final cut. Here is our short list of the top four, with some comments. We have them listed in order of their summit heights, even though a launch track might not reach it.

**Mt. Cayambe, Ecuador**

**19,160 ft., 0°** 40 miles NE of Quito, and 200 miles NE of the major Pacific coast seaport metropolis of Guayaquil. In the Andes, Cayambe is the only mountain on our list with neighboring peaks that might do just as well. The other three (Cameroon, Kenya, and Kinabalu) are stand-alone massifs.

Range Safety and clearance: best clearance is to the north for polar launches, for which Cayambe offers no advantage. 2,000 miles East to the Atlantic over the sparsely populated north Amazon basin.

**Mt. Kenya, Kenya**

**17,040 ft., 0°.** An extinct volcano with a beautiful and classic graduated slope. 300 some miles NW of the Indian Ocean port of Mombassa with a railroad connection. 100 mi. NNE of Nairobi and its major airport. The summit is sacred to some Kenyan tribes.

Range Safety and clearance: 300 miles west of the Indian Ocean coast (in southern Somalia) over sparsely populated terrain.

**Mt. Kinabalu, Sabah, Malaysia**

**13,455 ft., 6+°N.** Near the north east tip of the great island of Borneo. About 40 miles ENE of the South China Sea port of Kota Kinabalu, and 80 miles WNW of the Sulu Sea port of Sandakan. About 100 miles S of the southern tip of the Philippine island of Palawan.

Range Safety and clearance: 70 miles to open water to the East for eastward launches.

**Mt. Cameroon, Cameroon 4.2°N**

**13,353 ft., 4+°N.** 60 miles from the border with Nigeria, 10 mi N of the port of Buea (former capital of the former British Cameroons), and 50 miles WNW of the major port city of Douala. The western slope is subject to torrential rains.

Range Safety and clearance: Open water 25 miles to the south for southward launches only, a major drawback. Some 2,000 miles from the East African coast (in Somalia).

**Mountains without the Right Stuff**

Excluded from this list are active volcanoes, and mountains that lack good seaport access. Arthur C. Clarke fictionalized (“Fountains of Paradise”) a space elevator from a mountain in Ceylon (Sri Lanka) at 6°N. In truth, Mt. Pidurutalagala, the highest peak, is only 8,281 ft. and nearby Adam’s Peak a thousand feet less. Both, however, have good eastward clearance over the southern Bay of Bengal.

Any effort to pick a site and build a mountain-slope launch track would also have to factor in local political stability or the lack of it. If we were to pick just one such facility, serving all the world, my vote would have to be for Mount Kenya. It is tall, smack on the equator, central to the world’s population, has fair weather, good access to a major port, and arguably acceptable range clearance. 

## Launching PEOPLE to Orbit

LAUNCHING PEOPLE TO ORBIT By Peter Kokh

I remember Tom Rogers’ audience gripping pep talk at the banquet at the 1988 International Space Development Conference in Denver. He foresaw a day when people – workers, tourists, and settlers – would be the principal item shipped to space. Indeed, people are the one thing it makes sense to ship to space rather than produce there from on site resources. It will be this traffic that opens space. And until this traffic begins in earnest, probably with tourists, space will largely be a venue for a token scouting elite, and for Earth-bound armchair voyeur wannabes – like us.

If this proves true, Cheap Access to Space (“CATS”) solutions developed for large hardware items like space station modules and communications satellites may very well not prove optimal for the coming traffic in live-and-wanting-to-stay-that-way bodies. The Space Shuttle was early-on likened to an all-purpose “pickup truck” for space. That doesn’t make it qualify as a good bus or highway coach, much less a good family car. The shuttle and its paper study replacements are in fact crewed cargo ships, cargo ships that can take along a small hardy and hardened crew.

While hardware payloads may come in a set range of sizes, occasional oversized loads being low traffic items, the optimum size for a people shuttle will change as the sustained demand and volume of traffic grows. The 29 passenger DC-3 once did just fine. But today, it is often more economical to fly planes that carry several hundreds at once. The point is that a CATS solution not amenable to “scaling up” may be an unhappy choice as a people carrier, even if it does deliver airline style operation and fast turnaround time.

Shuttle time to orbital destinations is short, shorter even than the average domestic airlines hop – not counting the time you may have to sit on the pad prior to taking off! Given the expected shortness of surface to orbit flights, a high “packing” density in the cabin may be tolerable. Demand for a “window seat” may well be higher than that aboard airliners, given that the scenery will be much less prosaic. That “see one cloud, see them all; see one farmer’s field, see them all” attitude will not be common, even for seasoned shuttle travelers. This demand, if carriers choose to meet it, may place constraints on cabin design, and may make some SSTO configurations much more popular than others. Right now, in the early stages of CATS R&D, such considerations are at the bottom of the list. But in time, that list will be turned end for end.

Competing SSTO configurations may favor competing ground-based infrastructure (spaceport launch and land facilities). In the early days of space tourism, low traffic volume will bring with it few choices of gateways. If you want to go, you will not complain about flying to a distant departure field. But as traffic grows, at first chartered but eventually scheduled, it will be economical to offer more gateways, departure points convenient to more population centers or perhaps at more major airline connection hubs. If that is the case, SSTO configurations that are the less versatile and place higher and more expensive to meet constraints on spaceport infrastructure will lose out in competition (all else being equal) to those that can take off from nearly anywhere and land nearly anywhere.

The general public will want lower accelerations than seasoned crews can tolerate. This will be another major design consideration not currently given much weight. Compromises are inevitable, however. It could be for example, that the only way to bring the ticket price down to a mass-use threshold may be the use of an Earth-bound first stage such as a mag-lev sled at a high altitude, and preferably low latitude (near equatorial) “aerospaceport” and there will be few of these if indeed more than one. Such a development will move orbit-bound traffic in patterns opposite to the decentralized paradigm suggested above. The use of piloted piggyback flyback boosters would also tend to limit gateway choices.

When it comes to moving regular people traffic between Earth and Lunar orbits, and between lunar orbit and the lunar surface, still other vehicle configurations may prove to be the most economical. Thus, even though the McDonnell Douglas Delta Clipper family configuration is inherently more versatile when it comes to landing site, not even requiring an atmosphere, that doesn’t mean that just because it can land and take off from the Moon (or anywhere else) that it is the most economical configuration in that specialized environment.

Certainly for Earth-Moon ferry traffic, where we are concerned with flight times of many hours to a few days, cubic foot allowance per person will have to be much more generous, with diversions galore.

And when it comes to Mars, the usual “space shuttle” pattern will be set on its ear. Instead of a surface-based vehicle that can get to orbit and then return, we will need, at first at least, an orbit-based vehicle that can land anywhere (look, ma, no runaways) and get back to orbit. Who can say, (let’s agree to have fun here) perhaps for that purpose a saucer-shaped vehicle may do better than a winged one. After all, it is the orbit-based “surface shuttle” paradigm that UFO lore invokes.

So while we are supporting CATS, let’s be aware that the early answers may not prove to be the best answers – we need to explore all the options if we want not just to open space to more hardware, but also to more – quantum leaps more – people.



## AEROSPACE PORTS By Peter Kokh

In the last article, we suggested that it is conceivable that the least expensive per capita seat to orbit may be a vehicle that is booster- or track-launched from a high altitude near equatorial aero-spaceport. Let's play with that idea for a moment – not with the launch track or other captive booster stage options – but with candidate sites.

If we look at existing international airports, making the problematic assumption that our transatmospheric space-plane can take off and land within the typical boundaries of such facilities, what are the choices? They are not many. Most equatorial cities of size are ocean or river ports near sea-level.

Here are the three best exceptions:

**Quito, Ecuador 0° at 9,500 ft altitude.**

Quito is the capital and second largest city of Ecuador with somewhat less than a million people. It is a minor hub with most air and sea traffic coming into the country via the larger, more cosmopolitan sea level port of Guayaquil. The flagship national airline serving Quito's **Jose Marescal Inter-national Airport** is **Equatoriana**.

**Bogota, Columbia 4.4°N at 8,563 ft.**

Bogota is the capital of Columbia and its largest city, already one of the megacities of the Third World urban tropics with over 5 million people and growing rapidly. While it is slightly less well situated than Quito in both latitude and altitude, it is by far the more important air traffic transportation hub. The flagship airline is **Avianca**.

If space-bound traffic grows, Bogota could make an ideal western hemisphere aerospaceport, serving North, South, and Central America, with travelers electing to spend several days taking in the sights of this beautiful, colorful, vibrant, and cosmopolitan city.

**Nairobi, Kenya 1.5°S at 8,700 ft.**

Nairobi is the capital and largest city in Kenya, in the process of suddenly becoming a Third World super city with several million people, ten times or more its size in colonial days. **Nairobi** is the air traffic port of entry for most travelers to East Africa. **Air Kenya** is the flagship national airline. If high altitude equator based transatmospherics turn out to be the most economic way for tourists to reach orbit, Nairobi could some day be the "Space Safari™" jumping off point for three continents: Africa, Europe, and Asia (which has no low latitude high altitude city.)

Nairobi has the added advantage of being on the southern flanks of Mt. Kenya, whose western slopes offer an ideal site for a launch track for space-bound high volume commodity cargoes.

### **Top Cities/Airports in Comparison**

All three of these equatorial cities have modern airports which accommodate any fleet jet. But if existing hub traffic is a consideration, **Quito** loses the Western Hemisphere race to **Bogota**.

Would the national airlines that serve these cities (Avianca, Air Kenya) expand intercontinentally to funnel most orbit-bound traffic through their home hubs? Or will the traffic be up for grab with other national airlines competing on a level playing field? Might the transatmospherics themselves be owned by Avianca and Air Kenya, and thus be able to offer discount transfers to and from their hub feeder fleets? All these questions may be moot if the extra cost of airline flights to and from these equatorial hubs added to the cheaper cost of space passage from them comes up to a harder-to-swallow bottom line.

Yet there is more favoring the equatorial hub scenario than lower seat-to-orbit costs. Equatorial Earth orbit locations (hotels, resorts, and industrial parks), ideally suited for access from equatorial surface hubs, have a great advantage with a launch window to and from every 2 hours or so as opposed to once a day to and from cul de sac higher inclination orbits that maximize access from higher latitude spaceports like Kennedy and Baikonur. And it will be the equatorial orbit stations and depots which offer the most frequent launch windows and best fuel-saving advantages to and from the Moon and other deep space destinations like Mars.

**Bogota** and **Nairobi** Interplanetary Aerospaceport could grow beyond their edge as space gateway cities for people. They could become the terrestrial centers of solar system trade, trade shows, import and export markets, mineral and energy exchange boards, and more. After all, that is how great cities become great, by leveraging an at first minor advantage in an ever diversifying and pyramiding fashion. Perhaps it is good that there are at least two prime candidate cities, not just one.

**And if high altitude doesn't matter?**

What if high altitude becomes moot, and any equatorial city can compete for the trade? That opens the door to Guayaquil, Panama City, Cali and Medellin, Caracas, and Belem in Latin America but Bogota should handle that competition with no problem. Douala and Kinshasa might compete limply in Africa. Half a world away off by itself, Singapore would surely become the gateway for all Eastern Asia and Australia. (Its national flagship carrier Air Singapore is already the world's top-rated airline with Milwaukee-based Midwest Express a distant fifth. Just thought I'd throw that in there with ISDC '98 in Milwaukee only 20 months off.) Even if the advantage is with the high altitude cities, Singapore may garner a respectable East Asian market, its sea-level handicap meaning fewer paying passengers (less gross weight) and higher fares per flight to orbit on comparable equipment. **MMMM**

**Fixed vs. Variable  
Cabin Orientation  
for Launch & Land**

**i.e. Simple & Safe  
vs. Complex and  
Problem-prone**



By Peter Kokh

The recent winner of the X-33 competition, Lockheed-Martin's VentureStar is an apparently well thought out paper study design by Lockheed's famed Skunk Works, a team determined to overcome the considerable head start of McDonnell Douglas (the Delta Clipper program, with an actual successfully flying prototype).

VentureStar has a number of distinguishing features like its linear aerospike engine. But as a prototype upon which a future personnel carrier might conceivably be based it has one very salient characteristic that presents some challenges to passenger cabin design. VentureStar will take off vertically on its tail like the Shuttle, and again like the Shuttle, it will land horizontally. While this was probably not the deciding factor in its choice, NASA's cozy familiarity and complacency with the Shuttle may have added the appeal of psychological frosting to Lockheed's design.

Will passenger cabins on vertical take off horizontal land craft be fixed, so that passengers are pushed into their seats through their backs during takeoff, effectively lying on their backs with legs up, but sitting on their buttocks during landing, seats and postures remaining the same?



**Vertical take-off  
Passengers held  
to seats by their  
backs. Down is to  
the rear of the  
cabin.**



**Horizontal Land  
Passengers held  
to seats by the  
buttocks.**

How comfortable this take off posture will be for the general public is debatable. Given a choice for the same money, we think the above arrangement will prove disastrously unpopular.

Another possibility is a seat that unfolds into a berth for takeoff, and back into seat position for landing. This may work well enough.

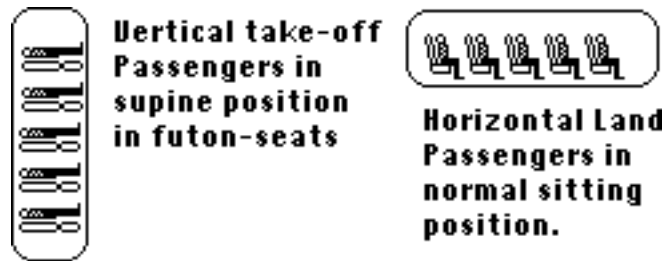

Clusters of Seats could be in Gimballed pods free to rotate so that gravity or powered acceleration is towards and through the pod floor, not the cabin floor in general. Force will at all times be felt, through the buttocks and feet. A model for this system are the little passenger pods that take tourists to the top of the St. Louis Gateway Arch.

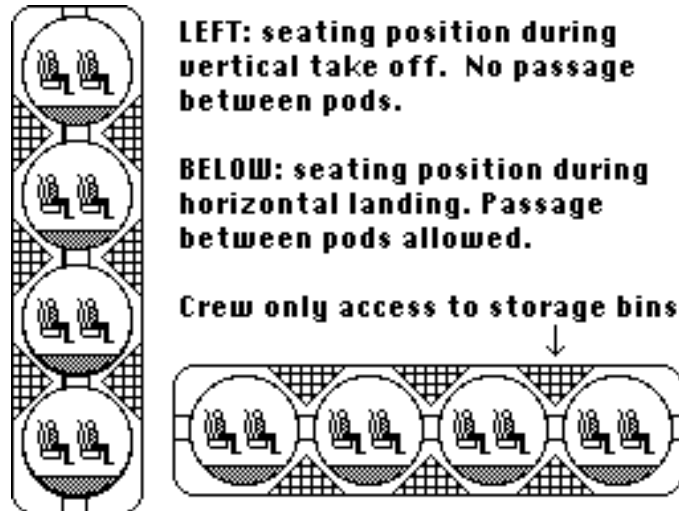

As flights are short, the reconfiguration of seat backs and postures or the closing off of clumsy cramped crawl-space passageways and gimbaling of pods are bound to be distracting, cumbersome, and annoying. Mere annoyance could change to trouble fraught with danger if a seat resists reconfiguration or a pod decides not to gimbal. It is curious that NASA which shrinks from tests of artificial gravity because of the engineering challenges, embraces a configuration which almost mandates one contrived Rube Goldberg accommodation or another. But there is a history of this, witness the Shuttle tile thermal protection system which is just as unnecessarily contrived (and expensive), mandated by an unnecessary choice of reentry attitude and angle.

In contrast, the VTOL, vertical take off and land, and HOTOL, horizontal take off and land, offer one simple unchanging configuration throughout both legs of the flight. "KISS," i.e. "keep it simple, stupid!" Fans of VTOL, the Delta Clipper's way of doing things, point out that a Clipper-configured craft could land on the Moon and take off again whereas a VentureStar-patterned craft could not.

VTOL would give us CATS and CATL (Cheap Access To Luna) in one craft. That is tempting. But is it the best route. Could there be cheaper craft specialized for LEO (Low Earth Orbit) to Luna runs just as VentureStar is best specialized for ground based shuttle operations to space on a thick atmosphere world? We must explore and test all the options. Only then can we have confidence in our choices. "God and Heinlein decreed that rockets should take off and land on their tails!" Maybe. Maybe not. I see problems with VentureStar's mixed mode operation. But it may just work.

**MM**



ORBIT TO ORBIT TRANSFERS By Peter Kokh

Presently, rockets must carry along all the fuel, and any extra stages, needed to get a payload in its intended final orbit. A payload brought up by the Shuttle destined for a higher orbit than the Shuttle



can reach, must carry along a throwaway pre-fueled kick motor to do the trick. Imagine how expensive it would be to fly to another city if we had to pay the freight for bringing along our own taxi (and its fuel) to get us from the arrival airport to our hotel or other destination! Carrying that fuel to orbit means either less allowable payload or a bigger and more expensive booster than would be needed if (a) the vehicle could be refueled upon reaching low Earth orbit, or (b) it was possible to “hire” a kick motor once in low Earth orbit to do the job.

### **Refueling in low Earth Orbit**

Given enough traffic following a given route into space, it should be feasible to orbit automated or remote control “tankers” that they could tap robotically or by teleoperation. Such a tanker could be sent up full, to be replaced and deorbit when empty. In time, permanent refueling stations parked in handy orbits, could “purchase” unneeded residual fuels and oxidizers from some vehicles to “sell” to others needing to refill or top off their tanks.

A 1988/'89 Space Studies Institute study outlined how such an orbiting cryogenic fuel depot, using spent Shuttle External Tanks, could be set up phase by phase. Most of the liquid Hydrogen and liquid Oxygen needed would be “scavenged” from residual amounts left in other ETs reaching orbit.

There are two logical orbital locations in either case (tankers used serially, permanent filling stations): in **the International Space Station yards**, and in **low equatorial orbit**. The latter would be far more useful, being more reachable, with less fuel, from most locations, and at maximum window frequency. An equatorial filling station alone makes sense for payloads bound for geosynchronous Clarke orbit or beyond, for the Moon, Mars, or elsewhere in the ecliptic-hugging Solar System. Building a refueling station in Alpha Town for vehicles and payloads intended for deep space would be a lot like putting a gateway for Europe-bound Americans in Patagonia.

### **Kick Motor “Tugs for Hire” – Orbitug Inc.**

The idea of an orbital transfer tug, manned or not, has been investigated for incorporation into Space Station operations. But as we have just seen, given the Station's intended high inclination (51°) orbit, such a tug would be much more useful in low equatorial orbit.

While the former might be agency operated, heaven forbid, the later is a prime entrepreneurial commercial opportunity. Tugs could be launch company owned and operated (Lockheed Martin, McDonnell Douglas, Boeing North American, Arianespace, Energiya, etc.), or time-share pool operated, or perhaps leased by independent operators. Of the major contractors, Arianespace, able to launch from a 6°N site in French Guiana, has a big advantage.

Legislation to insure the commercial option may no longer be needed but was proposed more than a decade ago in the “Space Cabotage Act.” Cabotage means the “coastal” trade in cargo, after John Cabot, the British explorer of the North American Coast (c. 1497). “Coastal” is appropriate as Earth's true “space coast” is not Brevard County, Florida but LEO to GEO orbitospace.

Tug fees would of course reflect weight and delta v required for the orbital transfer. But they would also reflect whether the payload to be boosted was delivered to the tug home base (filling station) or whether the tug had to go fetch it in some other orbit first. Tug return to base fuel expenditures would also have to be paid by the shipper. Now if these fees in total are appreciably lower than the alternative cost of bringing along a one-use throwaway pre-fueled kick motor, we have a viable entrepreneurial space business opportunity.

Tug services would be “by appointment” and reservation only, at least until traffic grew large enough to attract speculative operators, able to “earn a living” through payloads of opportunity.

Nor does the opportunity exist just for traditional chemical rockets. Tether operated momentum boosters, possibly solar powered, could easily carve out a number of high traffic niches

Manned tugs would be useful for carrying replacement parts to already orbiting satellites needing repair. If this service can be profitably provided in a timely fashion at less cost to the satellite owner than the procurement and launching of a replacement satellite, we have another prime commercial opportunity. Such a manned tug would be a natural complement to a commercially owned and operated station or industrial park facility in equatorial orbit, serving as home “port.”

Refueling prices could come down once made on Luna fuels are available in quantity and quality. We are talking about lunar liquid oxygen, silane (SiH<sub>4</sub>, a methane analog and hydrogen “extender”), and possibly powdered aluminum or liquid hydrogen aluminum slurry fuels.

Each of these “enhanced CATS” scenarios wait on a steady growth in traffic to become economically viable. For low Earth orbit is only “halfway to anywhere in the Solar System” [Robert A. Heinlein]. Orbital Filing Stations and Tugs for Hire may be where we will find our CATS price-reducing solutions in this theater of operations. MMM

## Coasting Earth to Moon & Earth/Moon to Mars



COASTING By Peter Kokh

### Propulsion Questions

**LANTR:** (Liquid oxygen [LOX] Augmented Nuclear Thermal

Rocket) — In Moon Miners’ [Review #18](#), JAN ‘96, Editor Mark Kaehny reprinted an article by Dr. Stan Borowski of NASA-Lewis, about a very promising new propulsion concept which could cut Earth-Moon transit time down to a day, and deliver more cargo to boot.

If total transit time is drastically cut, then the mass of shipboard facilities needed to keep passengers amused and content should be less. Less ship mass per capita [per fare] means less fuel needed per fare, or cheaper passage.

**NIMF:** (Nuclear rocket using Indigenous Martian Fuel)

In Moon Miners’ Manifesto # 30 NOV ‘89, we reported on Dr. Robert Zubrin’s concept for manufacturing both get-around Mars exploration fuel and return-home fuel from Mars’ atmosphere, instead of bringing it along from Earth. This scenario would cut drastically the size and mass of a ship or expedition needed to put a given crew and amount of equipment on Mars.

**AEROBRAKE:** a ship configuration that can present a large cross-section to the atmosphere upon entry or grazing, allowing it to dump momentum without firing retrorockets. Ships returning to Earth or Earth orbit from the Moon or Mars, and ships headed for Mars or Mars orbit can benefit from aerobraking. But this is an economic plus only if any extra mass needed to provide an aerobraking profile is less than the mass of fuel that would be burned in firing retrorockets. Thus it is a nice idea that presents design challenges.

**Dividing & Conquering “Delta-V”:**

**Shuttle-Ferry-Shuttle Rendezvous**

At first blush, Moon Direct and Mars Direct – the idea of transfer-free passage from one planetary surface all the way to another – is as mentally comfortable to those of us breast-fed on science fiction as an old slipper to tired feet. But what costs is fuel spent on changing momentum, accelerating and decelerating. We need to look at the structure of a passage from one planet to another. A few minutes of acceleration – days to months of cruising – a few minutes of deceleration. From the point of view of fuel expenditures, it would be ideal for an accelerating or decelerating ship to be as lean and pared down in per capita mass as possible. From the point of view of passenger comfort, it would be ideal if the long-cruising vehicle be as spacious and full-featured as possible, implying more, not less mass per capita. Contradictory indications, it would seem.

Bear in mind that deceleration and acceleration periods are an extremely brief fraction of total time of passage. Passengers don’t mind having nothing more than a seat to sit tight in for short periods. Bear also in mind, that a circuit-cruising ship that does not stop, but only makes once or twice a loop course corrections, need spend very little fuel on anything but emergency power generation.

The elegant answer then, is not Moon direct or Mars direct, but lean Earth surface to cruise ship rendezvous shuttle. comfortable circuit cruise ship s for near-Earth to near-Moon or near-Mars passage, and lean shuttles between Lunar or Martian surface and cruise ship rendezvous.

Note that all the delta V needed to go from Earth to Moon or Earth–Moon to Mars is spent on either end by briefly occupied spartan crowded shuttles. In contrast, the relatively luxurious, creature comfort bestowed cruise ships on which 99% of the passage time is spent, use hardly any fuel.

The burden of rendezvous by logic falls on the lighter vehicle. The mountain doesn't come to Mohammed. Rather, Mohammed goes to the mountain. The more massive vehicle has "the right of momentum," yes, akin to "the right of way." If the ferry has to brake into Earth or Mars orbit, making discontinuous interrupted trips to and fro, all such benefits are lost, and to be affordable, it would have to be as spartan as possible, just like a shuttle.

Another way such a scenario makes sense is that the cruise ships on which travelers spend by far the most time, can afford to be amply shielded from cosmic radiation and solar flares, whereas darting shuttles needn't be.

Now we can hardly run our first expedition to Mars in such a manner. But the benefits are so clearly apparent, that this is mission profile we need to aim at if we are going to sustain any amount of traffic – regularly scheduled expeditions to a sequence of immigration waves to tourism.

### Relevant Readings From MMM Back Issues

MMM # 21 DEC '88 "Lunar Overflight Tours"

MMR # 12 JAN '93, pp 2–8 "The Frontier Builder: An Earth–Moon Hotel Cruise Ship." Definition & Design Exercise, Doug Armstrong and Peter Kokh

MMM # 80 NOV '94 "Stretching Out," P. Kokh

### Relevant Readings From Other Sources

Ad Astra July/Aug '96, pp. 24–27. "Recycling Our Space Program: No Deposit ... No Return," (Earth–Mars Cycling Ship scheme) Buzz Aldrin and Leonard David 



## To/From the Lunar Surface

By Peter Kokh

How do we cut expenses for landing on the lunar surface? Use as low-mass a landing vehicle as possible to bring down the equipment, supplies, people, etc. Leave unneeded mass in orbit. See last article. In addition, we can pursue these strategies.

### Fuels and Oxidizer from Moondust

- **Liquid Oxygen** for fuel oxidizer is the most obvious opportunity to save. There are many ways LOX can be processed from the lunar regolith soil. "LOX" can even be used to refuel Moonbound vessels in low Earth orbit.
- Less potent but quite adequate, **powdered metals** (alone or in a liquid hydrogen slurry) can be used in place of hydrogen. Abundant lunar aluminum, iron, calcium, and magnesium will do well. **Aluminum** oxygen combination is the most potent but it will take a lot of equipment and energy to produce the aluminum powder. (A 75% aluminum, 25% calcium alloy is easier to keep powdered). Pure **iron** powder is everywhere, especially on the mares, and can be produced easily by passing over the soil with a magnet. The exhaust is rust powder which will fall harmlessly back to the surface without degrading the lunar vacuum.

### Densifying Hydrogen Extenders

Hydrogen may make the ideal fuel, but on the dry Moon, even if there is some polar water ice, hydrogen will be a precious commodity and using it – at least in unextended form – will constitute an obscene waste of an invaluable and limited and expensive resource. Two ways to use it as a fuel extender are as a slurry medium for powdered metal fuels (above) and in chemical combination with other elements. One of the hydrocarbon analogs of Moon-abundant silicon will do such as Silane, SiH<sub>4</sub>, the silicon analog of methane, CH<sub>4</sub>. According to Dr. Robert Zubrin, Silane can be produced in a Sabatier

Reactor (the nuclear thermal powered device he successfully demonstrated for the production of methane fuel from Mars' atmosphere).

Economic pressures (impatience for short term advantage and profit at the expense of long term sanity) to use precious lunar hydrogen reserves directly will abound and there are many "damn the future" space advocates ready to do just that – some of them prestigiously placed. By treaty or lunar charter, it is in the interest of future Lunans and their civilization to restrict such use with adequate safeguards and stiff penalties.

### **Landing without Retrorockets**

Mars fans are quick to point out that thanks to its atmosphere, it will be cheaper to land people and cargo on Mars than on the Moon. But there are a few tricks other than aerobraking that can be used on the Moon in similar fashion.

- Krafft Ehrlicke described a "Lunar Slide Lander" that would dump horizontal momentum into a prepared regolith runway in Lunar Industrialization and Settlement – Birth of Polyglobal civilization" in "Lunar Bases and Space Activities of the 21st Century" ed. by W.W. Mendel, Lunar and Planetary Institute, Houston 1984, pp. 825–7.
- In what we hope is an improvement on this idea, Doug Armstrong and I published an article on "Enhanced Harenobraking" [sand-braking] in MMM # 55, cited below. It is conceivable that some limited application of this trick could be used to shed some of the momentum of an incoming personnel carrier.
- Cushioning Farings of non volatile material – e.g. metal and ceramic foams might land G-hardened payloads on the Moon intact, in specially restricted landing zones where they can then be "harvested."
- Chicago inventor Ed Marwick has put forth an elaborate proposal in which guided payloads enter a sloping chute dug into surface and encounter ever denser sprays of regolith dust, slowing the capsule down to a halt. Such a facility would have to be as long as a mass driver per level of Gs to be tolerated.

### **Loading and Unloading Facilities**

The earliest ships coming to the Moon to set up operations in any given development area will be "self-unloaders" weighted down with the cranes and winches needed to unload and reload themselves. Landing on and launching from the Moon will take less fuel and be cheaper, once such equipment is set up on a site, thereby establishing a "port." "Go anywhere" craft will operate at a competitive disadvantage as compared to craft designed to trade via an established lunar surface port facility. Population will follow, so that port-establishment will tend to be outpost and settlement site preemotive. (The same applies to the establishment of fuel processing facilities and fuel depots, harenobraking smoothways, electromagnetic launchers and catchers, etc.)

### **Electromagnetic Launchers**

Mass Drivers have been principally investigated for the regular continuous shipment of unprocessed lunar regolith into space for production of building materials for Solar Power Satellites and Space Settlements. Such devices provide very high G launch over relatively short mag-lev tracks.

### **Other elaborations are possible:**

- value-added pelletizable processed materials
- G-hardened small size manufactured items
- Larger items (cargo holds, personnel pods) in more potent, longer, slower accelerating launch tracks

Reversing mass drivers or Mass Catchers which catch and brake landing payloads have been mentioned and need further investigation for high traffic situations. In most cases this will not require a new facility, just a new "reverse" mode use (where launch demand allows) for an existing mass driver.

Mass Drivers-Catchers are expensive big ticket items. They will lower costs to and from the lunar surface only when amortized over a long period of high traffic use.

### **Relevant Readings From MMM Back Issues**

MMM # 6 JUN '87 "Bootstrap Rockets"

MMM # 55 MAY '92 "A Better Slide-Skid Lander? Enhanced Harenobraking"

MMM # 56 JUN '92 "Harbor & Town"





### Early Orbit-Based Shuttles

The first expeditions to Mars will have to use orbit-based self-unloading, self servicing and self-launching shuttles. There are no ready to use port facilities on Mars. An aero-braking shuttle cannot land like Columbia and siblings. It can glide-in only to lose most horizontal momentum, but then must either finish the job by using retrorockets to land on its tail or vectorable thrust to land like a harrier.

Preparation of a **runway** for wheeled horizontal landing and take off would make sustained operations easier, but is a down-the-list priority.

**NIMF** shuttles and hoppers {nuclear rockets using indigenous made-on-Mars fuels like methane and oxygen) will be enormously cheaper to fly than those that must carry launch and return fuel down with them from orbit, indeed, all the way from Earth.

The NIMF scenario is versatile. Shuttles that will be on a location long enough to process their launch and return fuel can land anywhere. For quick trips, a fuel processing plant must be pre-landed on a selected site. A **depot network** of NIMF plants around the Martian globe at well chosen sites will accelerate the opening of the planet.

Early traffic to Mars would also benefit from a fuel processing plant on **Deimos** or **Phobos**, at least marginally. This would be an early high priority item, especially for traffic (processed hydrogen, nitrogen, and carbon volatiles such as liquid methane and ammonia for trade to the Moon in exchange for made-on-Luna equipment / provisions) to the Martian moonlets themselves might be a major development on which Mars surface operations are economically piggybacked and subsidized.

### Later Ground-based Shuttles

If sustained traffic warrants (a decision to establish a permanent exploration base etc.) a true port facility can be established. In effect, this would change "Home Port" from Earth to Mars. Such a full-function port facility would be site preemptive, in that by making it far cheaper to land and take off from that location, traffic to other "undeveloped" sites on Mars would struggle at a major competitive disadvantage. Infrastructure is a strong magnet and activity polarizer. First site to establish it, wins.

Any Martian spaceport could also double as an airport. Cargo and passenger aviation on Mars, perhaps with hydrogen-buoyancy lift assistance is a strong feasibility. Its early development will be crucial to opening up the planet.

### Up/Down Western/Eastern Pavonis

One of the most specially advantaged pieces of real estate in all the solar system is the very high (15-23 km?) extinct shield volcano Mons Pavonis ("Peacock Mountain") which sits astride the Martian equator on the Tharsis uplift. Its gentle western slope is a textbook site for launch track operations of any kind, far better than any of the mountain candidates on Earth (see earlier article this issue).

A launch track is a captive ground-based virtual first stage which shaves major engine, tank, and fuel weight off the remaining mass that has to be accelerated into orbit and subsequently maneuvered.

### A Pavonis — Deimos Elevator

On Earth, the idea of a space elevator to a Geosynchronous facility 23,000 miles up using yet-to-be invented filaments of unbelievable tensile strength is an attractive, if very far off, theoretical possibility (Arthur C. Clarke's "Fountains of Paradise). It would reduce the cost of access to space to that of a small electric bill. Such a construct will be much easier (therefore much earlier) to install for an asteroid (like Ceres) where the distance to be covered and gravitational stresses involved will be orders of magnitude less.

On Mars, two assets will hasten the opening of a space elevator: Pavonis Mons and Deimos, a potential elevator–anchoring mini asteroid like body only slightly further out than Mars–synchronous orbit, and conceivably movable into place. But the timetable for such a development will be contemporary with major efforts to terraform (we prefer “rejuvenate”) Mars itself into a friendlier place for human habitation.

### Relevant Readings From MMM Back Issues

MMM # 18 SEP '88 “Pavonis Mons”

MMM # 73 MAR '94, pp. 3–5, “Urbs Pavonis / Peacock Metroplex: the Site for Mars’ Main Settlement.”

MMM # 56 JUN '92 “Harbor & Town”



## MMM #101 – December 1996

### Our 10th Anniversary Issue: A look back ... and forward

IN FOCUS “Getting there is half the fun!”

*Ad Astra per Ardua - To the Stars through Hard Work*

#### Looking Back – The Past Ten Years

I remember the deep sense of satisfaction I had when I finished collating MMM #2. After all, a very high percentage of new newsletter and magazine starts never get beyond Vol. I, issue #1. Suddenly I’m putting the finishing touches on # 101!

Ten years! We’ve collectively seen a lot, and been through a lot. Pushing our dream, an open space frontier in which development of off Earth resources includes off planet settlement, has not been easy, smooth, guaranteed. Ours is not the role of cheer-leading spectators, and those who’ve joined our ranks for the bandwagon thrill of being aboard a surefire winning program with no setbacks have long since become disheartened and jumped ship. As have many of those who can’t see past all the irrelevant inside politics. As have those who have identified particular paths to the future as the only ones.

We began this venture, we founders of the Milwaukee Lunar Reclamation Society L5, back in the fall of 1986, little more than half a year after Challenger exploded, and with the real disaster of public and governmental reaction still unfolding. It would be another two years before the next Shuttle flight. And already, in this interim of seeming inactivity, we were looking for alternatives and options. We talked about Dr. T.D. Lin’s concept of a 210,000 square foot lunar outpost made with 2 million tons of lunar regolith and lunar concrete (and 55 tons of imported hydrogen). We told our readers about the bold lunar real estate turnkey outpost development plans of Lady Base One’s Mitch Mitchell. We worked hard to get the proposed non-agency Lunar Polar Probe effort back on track and Lunar Prospector was born, put in suspended animation, and then revived to fly this coming year.

Reagan’s Space Station “Freedom”, not the von Braun/”2001” wheel we had all hoped for, promised room for four astronauts in space at \$8 billion per bed, got cut short to Space Station “Fred”, then “Fried”. Expecting Congress to deal the merciful coup de grace, we sat in on an ultrahigh level back room DC meeting to resurrect Station from its ashes, commercially. Clinton’s uncanny political wisdom found another way, redesigning Station around the Russian Mir II, selling it as a way to help keep afloat and on track a new democratic Russia. International Space Station Alpha’s high inclination orbit, a concession to the Russian–Kazakhi launch site at Baikonur, makes it that much less suitable as a staging base for deep space operations, guaranteeing that commercial stations will in fact come, and perhaps sooner than most think.

We cheered as Endeavor was built and flew as a replacement for Challenger. We cheered as it, and the other orbiters were outfitted and retrofitted for extended duration missions. And we were all greatly enheartened by the current Shuttle–Mir missions. The Shuttle was finally going some–where! Yet there have been temporary setbacks: Hubble’s optical problem, the failed tether experiments, and more.

At first just a few of us, then more and more until it became consensus, saw that NASA's Mother-hood-and-Apple-Pie Space Transportation System involved a radical misdirection of the agency's purpose, that a 5th orbiter should not be built, that we had to privatize space transportation, that as marvelous a machine as the Shuttle was, Proxmire was right after all, when he predicted that rather than lowering per pound costs to orbit, this all purpose space pickup designed-by-committee would raise them. A replacement vehicle development program was announced: NASP, the National Aero-Space Plane. But it became a victim of its own price tag and many were disheartened.

Yet the rebellion to put a sunset limit on the Shuttle and begin work on a radically new work-horse calculated to usher in "Cheap Access To Space" had begun. It quickly won converts – not-so-amazingly becoming mainstream, given its irrefutable inner logic. The Shuttle was the door to space all right, a locked heavy door that no one but the government could afford to open. It defeated its own purpose.

We watched in minority horror as Bush announced the pop-heralded Space Exploration Initiative – in horror, we say, because by failing to list compelling reasons for a return to the Moon, and an opening to Mars, Bush delivered a proposal to Congress that was irretrievably Dead On Arrival.

Yet, while the absurd space opera of ultra expensive government space scenarios continued to play to the cheers of diminishing audiences, a new prophet emerged with a visionary sketch of radically less expensive mission plans to the Moon as well as Mars, enabling direct Earth surface to lunar and Martian surface round trip flights, bypassing the dead end preemptively expensive station, with the simple common sense of the frontiersman pioneer – using local on site resources for refueling and re-supply. Many quibble with the details of Robert Zubrin's breakthrough visions. Yet no one still seriously espouses the old totally umbilical mission philosophy. That is an enormous tribute to the power of Zubrin's new paradigms which continue to unfold.

[snip: rest of this editorial deals with transportation-unrelated issues]

## **The Artemis Project™ Reference Mission plan for Lunar Landers**

The Artemis Society's Artemis Project™ Reference Mission plan for Lunar Landers is to use already off the paper, and purchasable SpaceHab modules coupled in double or triple configuration. Each of these by itself offers much more usable volume than did the Apollo era Lunar Excursion Modules Eagle, Intrepid, Antares, Falcon, Orion, and Challenger. Unlike these, the SpaceHab complex would stay on the Moon, and not be used as return capsules.

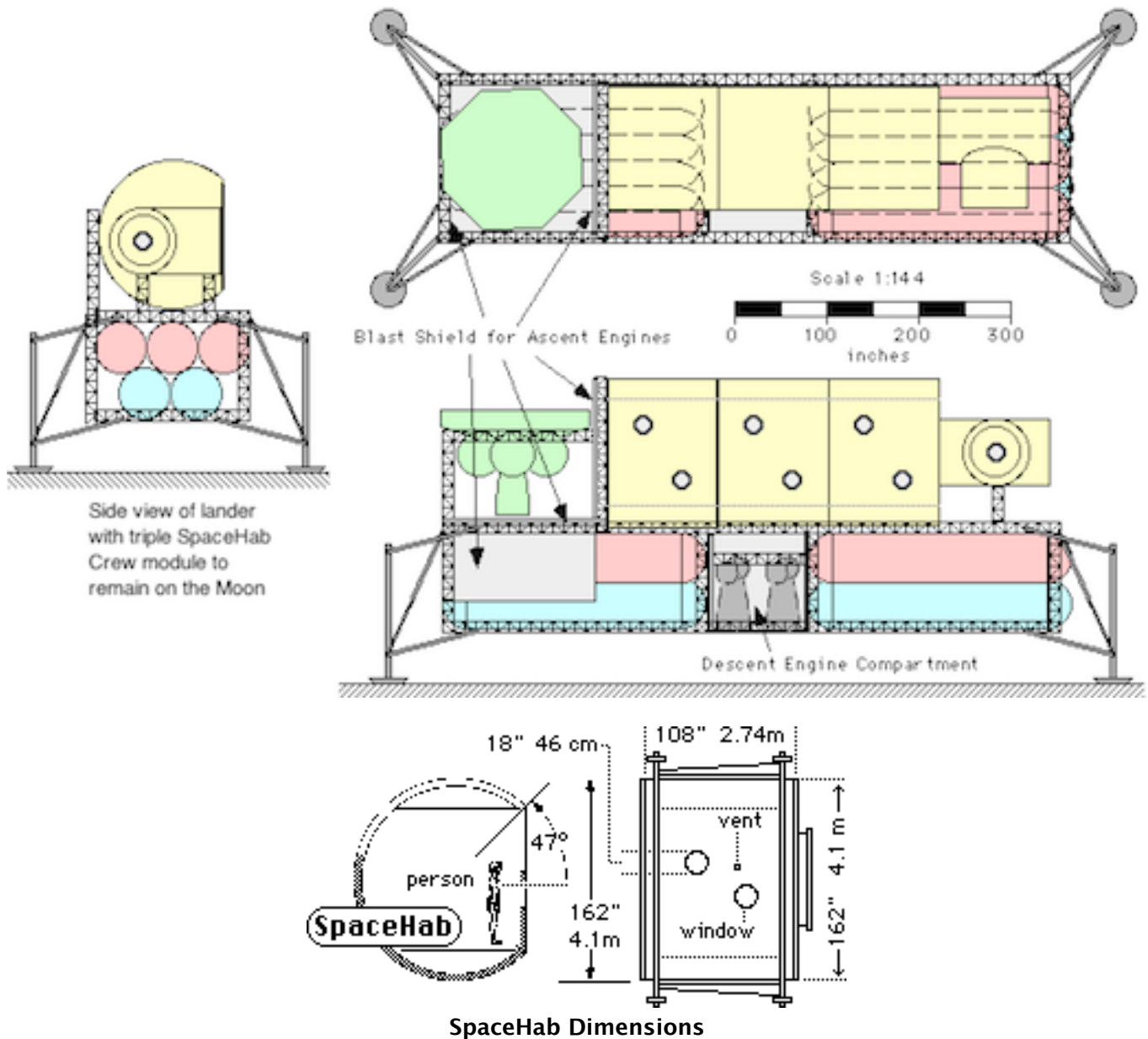

MMM #106 - June 1997

## Replenishment of an Orbital Propellant Depot by Means of a Coil Gun

(SEI & Stafford) by Rodney Kendrick

For trips to geosynchronous orbit, the Moon, or beyond, a low Earth orbit fuel depot is essential. This proposal describes a method for resupplying an orbiting depot with up to 14,000 kg of propellant (produced from water ice) daily. Water is dense and inert, yet when electrolyzed and liquefied, it can become a high energy propellant.

A recent article (Breck, Henderson, "Sandia Researchers Test 'Coil Gun' For Use in Orbiting Small Payloads." Aviation Week and Space Technology, May 7, 1990, pages 88-89) described the capabilities of a "coil gun" for launching payloads into low Earth orbit. This coil gun would replace costly rocket propulsion with cheap electricity.



This proposal calls for building a coil gun and rocket combination capable of placing a 10 kg payload of water ice in orbit. The gun would be sited on the equator and fired due east. A very small maneuvering motor would circularize the orbit at 277 km altitude. Firing one shot every minute would thus produce a ring of orbiting payloads about the Earth.

The depot would orbit at 300 km at an inclination of zero degrees. It would consist of tankage, electrolyzer, liquefaction machinery, power plant, and a 23 km tether. This would extend down to the 277 km orbit with a large net at its end. The end of the tether would not be in orbit, and the orbiting payloads would pass through the opening of the net at a closing velocity of 40 m/s where they'd decelerate and be captured. Thus a difficult rendezvous maneuver would be avoided. The captured water ice would then be pumped up the tether to the depot.

Economies of scale could come into play. With up to 500,000 shots a year, the price per shot should be quite low. The per year payload equivalent will be that of over 40 Saturn V's.

<SLuGS>

=====

13 Years Later, Dallas Bienhoff, Boeing, would release his paper on how we can provide orbital refueling and thus greatly reduce the cost of missions beyond Low Earth Orbit in his Presentation

**“The Top Ten Technologies for Reusable Cis-lunar Transportation”**

[http://blog.altius-space.com/wp-content/uploads/2010/11/101030\\_SSI\\_Valentine.pdf](http://blog.altius-space.com/wp-content/uploads/2010/11/101030_SSI_Valentine.pdf)

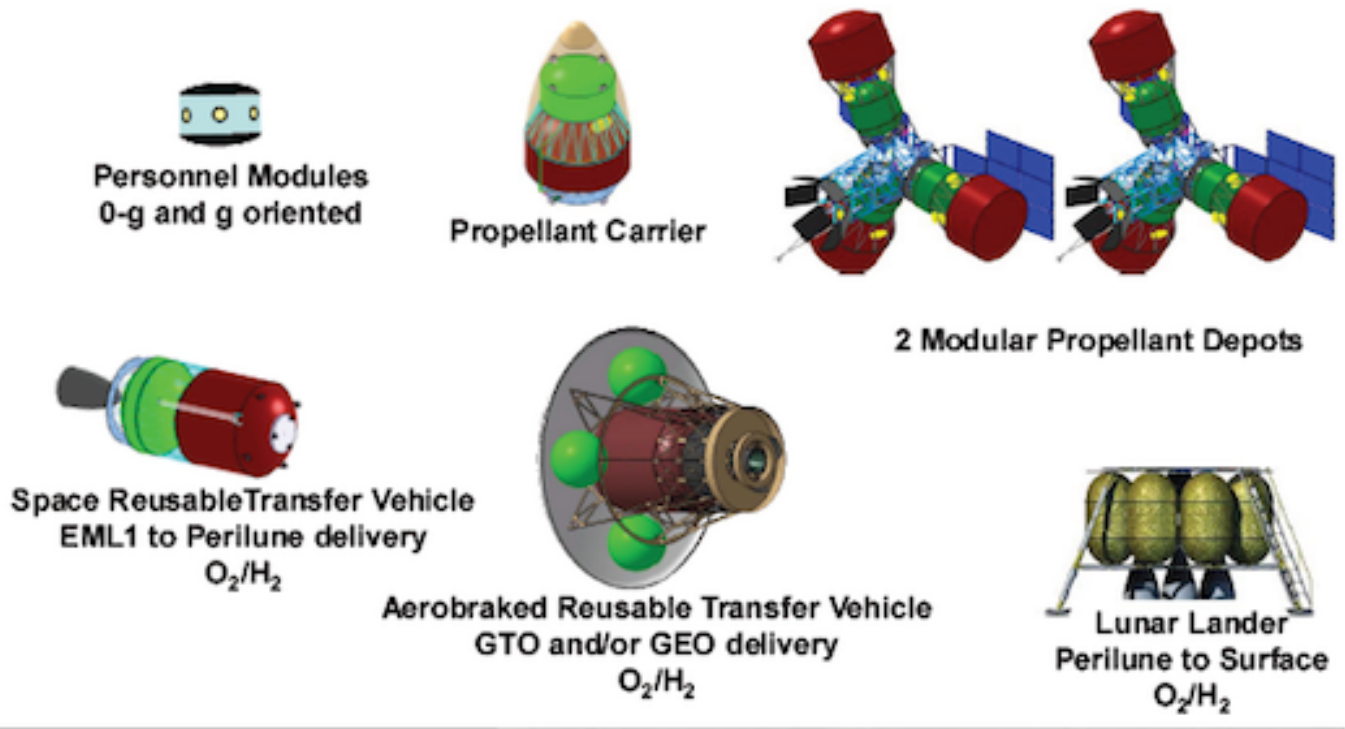

**MMM #107 – July 1997**

**NOTE:** the following relevant contributions to this issue of MMM were courtesy of SLUGS (Seattle Lunar Group Studies) arranged by David Graham, to help the MMM editor who was quite busy preparing for the 1998 International Space Development Conference in Milwaukee, of which he was Chari.

## A Cislunar Ferry

Gordon Woodcock(1) and Joe Hopkins, SLUGS (Seattle Lunar Group Studies)

We propose a vehicle be developed to utilize swing orbits (Woodcock, 1). The vehicle would be designed to travel in the lunar plane between Earth and Luna, providing frequent and regular access to both bodies.

This vehicle could be viewed as a cislunar ferry. In its initial form, the orbiter would be a small, no gravity, passenger/freight carrier. The cycling orbiter could be configured to provide radiation shielding for the passenger section. If gravity becomes necessary, it could be simulated by spinning equal massed compartments opposite each other on a tether.

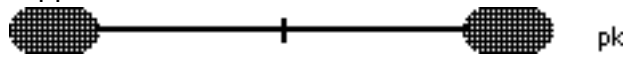

[Actually, it is not necessary that both opposing components be equal in mass – unless equal levels of artificial gravity are required at both ends. If this is not required and the two components are unequal in mass, the center of gravity or fulcrum simply lies proportionately closer to the heavier mass while the gravity felt in the lighter more distant component will be the greater – Editor.]

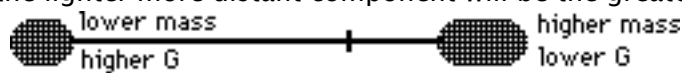

Regular, inexpensive transportation between the Earth and Moon is the main purpose of the orbiter. Cargo and passengers would be transported on and off of the orbiter in specially designed taxi modules. Passengers would generally remain on board for only one leg of the trip at a time; three to five days.

Over time, with a system like the cislunar ferry, transshipments from the Moon to low Earth orbit would become cheaper than such shipments from Earth. Early shipments could include oxygen, unprocessed lunar rock (for shielding) and agricultural products. As lunar bases develop, processed metals and glasses could be included.

Shipments from Earth to the Moon would be precision tooling equipment and electronic supplies. Organic waste generated onboard the cislunar ferry and in low Earth orbit could be sold to Moonbase farms. The orbiter would also be valuable as a research facility.

<SLUGS>

(1) Woodcock, Gordon R., Transportation Networks for Lunar Resources Utilization, Space Manufacturing 5; Engineering with Lunar and Asteroidal Materials, American Institute of Aeronautics and Astronautics, New York, Proceedings of the 7th Princeton/AIAA/ Space Studies Institute Conference, May 8–11, 1985

## Magsail Asteroid Survey Mission

(SEI & Stafford) by Stan Love and Dana G. Andrews

The asteroids, lying principally between the orbits of Mars and Jupiter, have long been considered one of the best potential sites for near term access to extraterrestrial resources. To fully assess the value of asteroids for commercial use, and also to gain scientific knowledge about them which is critical to our understanding of the formation of the solar system, it is necessary to examine a large number of them a very close range, perhaps even collecting samples of their surfaces for analysis on Earth. Such a mission is unthinkable with current chemical rockets, however. Each flyby would require a few km/s of velocity change (hence approximately doubling the initial mass of the spacecraft) and no surface landings could occur without expending a prohibitive amount of propellant.

The magnetic sail (Andrews, D.G. and Zubrin, R.M., "Progress in Magnetic Sails," AIAA Paper 90–2367, 1990) suggests a solution to this problem. It would derive its thrust from the interaction of the solar wind with the magnetic field around a loop of superconducting cable several dozen km in diameter. As long as current flows in the cable (once set up, it will continue to flow indefinitely) the sail would develop a small amount of thrust, which could be directed by altering the orientation of the loop or by

changing the current, easily accomplished with a modest-sized solar array. Since it would produce a continuous force without expending any propellant, a magsail could orbit the sun in the asteroid belt indefinitely, visiting tens or hundreds of objects at a relative velocity of a few km/s.

Asteroids possess no magnetic fields to hinder the use of a magsail. Neither do they have strong gravitational gradients, which are difficult for any low-thrust vehicle to overcome. If the mission profile allowed the necessary deceleration time, the spacecraft could rendezvous with asteroids to take samples of their surfaces. Proper alignment of the sail and the asteroid could be arranged so that the sail force and the gravitational attraction of the asteroid exactly balance one another, allowing samples to be taken of the surface from a motionless spacecraft. After sampling a number of asteroids, the spacecraft could return to Earth to drop off material samples and undergo routine maintenance. It could then return to the asteroid belt for further exploration. <SLuGS>

## **Magsail Mars Missions**

(SEI & Stafford) by Dana G. Andrews, Stan Love, and Joe Hopkins

Regular round trip missions to Mars could be undertaken using a magnetic sail, or magsail, spacecraft. A magsail would derive its thrust from interaction between the thin plasma of the solar wind and the magnetic field surrounding a current-bearing loop of superconducting cable roughly 100 km in diameter. Once a current was established in the loop, it would continue to flow indefinitely, providing thrust until the current was cut.

Directing the thrust could be accomplished by changing the orientation of the loop or by altering the current; both easily accomplished with a modest-sized solar array. The magnetic sail concept was originated by D. G. Andrews in 1968, but was not feasible until recent developments in superconductors that allow for cable that could be kept below its critical temperature with a simple and light-weight passive cooling system.

An additional advantage of the magsail is that the current loop would generate its own magnetosphere, much like that of the Earth, but on a much smaller scale. The magnetic field of the sail would protect the spacecraft's payload (and, in particular, its living passengers) from most charged particle radiation, decreasing the requirement for massive and costly radiation shielding on manned missions.

A recent paper (Andrews, D.G. and Zubrin, R.M., "Progress in Magnetic Sails," AIAA Paper 90-2367, 1990) describes a manned mission to Mars in 2007 with an initial mass of 200 tons and a payload of 140 tons. This payload is comparable with the payloads of other low-thrust manned systems currently under consideration.

A flyby of Mars is projected 164 days after departure from Earth. The payload and crew taxi would return to high Earth orbit after a total of 668 days. The spacecraft could then be refitted for the next launch window, occurring 90 days after arrival. Since proper alignment of the two planets occurs at regular intervals and the magsail could make the round trip with time to spare, it could be used as a permanent facility cycling between Earth and Mars. <SLuGS>

## **Magsail Stabilization of Lagrange Point Structures**

(SEI & Stafford) by Stan Love

In numerous schemes for the development of cislunar space, propellant depots, mass catchers, and other facilities have been proposed at the various Lagrange points of the Earth-Moon system. Of these five points, only two, L4 and L5 (at 60° leading and trailing the Moon in its orbit) are stable against the small, constant gravitational perturbations present in the system. The two Lagrange points nearest the Moon, L1 and L2, are probably the most useful for lunar missions. Facilities constructed there would have to be constantly supplied with propellant to compensate for gravitational perturbations, or they would soon drift into other, less useful orbits.

The magnetic sail (Andrews, D.G. and Zubrin, R.M., "Progress in Magnetic Sails," AIAA Paper 90-2367, 1990) suggests a solution to this problem. It would derive a small amount of thrust from the interaction of the solar wind with the magnetic field around a loop of superconducting cable roughly 100 km in diameter.

As long as current flows in the cable (once set up, it will continue to flow indefinitely) the sail would develop a small amount of thrust, which could be directed by altering the orientation of the loop

or by changing the current, easily accomplished with a modest-sized solar array. It would be capable of making the necessary continuous orbit modifications without expending any propellant at all, hence eliminating the need for large resupply missions. Operating a mag-sail in the near-Earth environment would require that some consideration be made of the Earth's magnetotail, but this would probably not impact the sail's usefulness.

Another advantage of the magnetic sail is that it could generate its own magnetosphere, much like that of the Earth, but on a much smaller scale. The magnetic field of the sail would provide good shielding against charged particle radiation for anything in its immediate vicinity, and would thus lessen the need for heavy and expensive radiation shielding of manned outposts.

<SLuGS>

## Regolith as Propellant for Mars Missions

(Stafford) by Brian Tillotson

This is a proposal to use a coaxial electromagnetic accelerator (a.k.a. coil gun or mass driver) as a rocket engine for a Mars mission. The proposed propellant for the outbound journey to Mars is regolith (dirt) from the Moon, and the propellant for Mars orbital maneuvers and for return to Earth is regolith from Demos or Phobos.

O'Neill proposed use of a coil gun or mass driver as a rocket motor which ejects inert material at high speed to produce thrust. Recent coil gun demonstrations show that technology is in hand to realize this propulsion concept. With this concept, raw regolith is a suitable propellant. Regolith is less expensive than other proposed extraterrestrial propellants, which require heavy equipment delivered from Earth to chemically process raw materials.

**Value:** Use of planetary regolith addresses two needs for Mars mission design: low IMLEO and protection of the crew from galactic cosmic radiation (GCR). The concept avoids the cost of launching propellant from Earth, and the regolith can be used as shielding for most of the mission.

Several other advantages are realized. Propellant is stored in a bag which is folded and launched empty from Earth; this gives less launch volume than liquid propellants which are launched in rigid pressure tanks. Neither cryogenic storage nor in-space fluid transfer technology is required. Smaller power systems are required than for ion-propelled vehicles. Crews need not crowd into a storm shelter during solar flares. The proposed Moonbase finds a clear purpose.

**Performance Characteristics:** Using assumptions described in the background paper, the proposed vehicle's Earth mass (including lunar infrastructure) is 24% lower than a solar electric ion-propelled vehicle's mass. GCR dose to the crew is cut by more than half. The required electrical power is only 26% as large as for an ion vehicle.

**Enabling Technologies:** Coil gun launcher technology is advancing rapidly. Development should be directed to two new areas: 1) coil guns as flight-qualified rocket engines, and 2) a coil gun launcher on the lunar surface.

**Relation to Mission Objectives:** This concept may be enabling or enhancing for a manned Mars mission in two major ways. First, it may be cost enabling or enhancing by reducing the mass of Earth material launched into space. Second, it may be medically enabling or enhancing due to reduction of crew radiation dose. By providing a rationale for lunar support of a Mars mission, the concept increases the political likelihood of a permanent manned return to the Moon

<SLuGS>

MMM #108 - September 1997

### Simple ways to Demonstrate Artificial Gravity

BELOW LEFT: two shuttles are linked by tether or a boom from their centers of gravity inside their payload bays, and the combo spun up by thrusters.

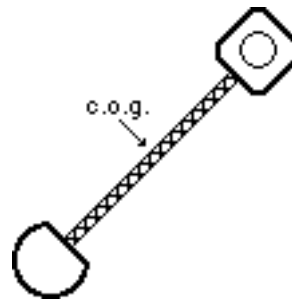
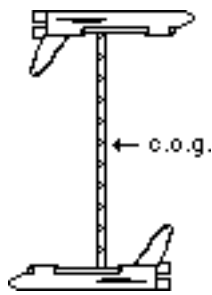

ABOVE RIGHT: Three elements bound for incorporation in the International Space Station Alpha are first put together nearby for an artificial-G test: a SpaceHab Module, a Node, and a truss section. The assembly is spun up/down by small thrusters or a fly-wheel.

## IN FOCUS

### We need an “X-Prize” for In-Orbit Artificial Gravity

Commentary by Peter Kokh

When the Reagan government committed in '84 to building a Space Station, perhaps many of us conjured up the vision of Von Braun's "wheel" as depicted so well in the epic Kubrick/Clarke film; "2001: A Space Odyssey". Alas, neither NASA nor its contract-seeking aerospace has ever entertained the idea of realizing an artificial gravity platform in space. No allusion is ever made to Von Braun's dream, and the whole idea lies buried in an unmentioned limbo in an unspoken partners conspiracy of silence. Instead, throughout the long rocky road to Freedom, Fred, Fried, er ... ISSA, what we see instead is the pursuit of validating the medical-physiological-mental feasibility of year(s)-long duration "micro"-gravity to demonstrate the possibility of an eventual exploratory science picnic strike at Mars.

NASA has not been without opportunity to experiment with artificial gravity. All it takes is two shuttles or two modules or other roughly comparable masses co-rotating around a common center of gravity via adjoined tether. But we suggest that there is a reason, a rather insidious one from our own shared point of view as would be settlers of the solar system, why we have seen no such efforts, not even so much as official paper studies (!) to date. The reason is this: demonstrating the engineering and physiological feasibility and validity of artificial gravity would be tantamount to a storming of the Bastille, to the sudden realization that mankind might be on the verge of Cradlebreak! For with artificial gravity, we could travel to and from Mars and points more distant with relative ease, arriving with the strength necessary to tackle the scouting, the exploration, the experimentation, the outpost building - whatever - upon reaching our destination without having to waste precious time in bed rest reacclimating ourselves to gravity.

Artificial Gravity opens the way for O'Neill type construction shacks, Bernal Spheres, Torus settlements and giant Sunflower worldlets. It would open the way to serious industry in space, to space settlement. Rotating habitats would allow asteroid miners as well to work healthfully, safely, productively, and be able to come home, if and when they so decided. Abracadabra, artificial gravity would open the Solar System at large as a humanizable domain. For the government, wanting to keep the space program "tamed and domesticated", innocuously contained within Earth-orbit "fringe-space", the potential financial commitment such a Cradle-breakout technology might encourage is sure to send cryogenic chills down the spines of any public official, not just the grim dream-reapers of the Office of Management and Budget.

Whether the infamous Roswell incident involves a government conspiracy or not, pales into insignificance long-term with the virtual conspiracy against even basic and rudimentary experimentation with artificial gravity.

As much as we need Cheap Access to Space, as much as we need space nuclear propulsion, nothing stands to blow the lid off of the limits to human dreams like the realization of artificial gravity. We aren't going anywhere without it, not beyond the Moon in any significant way. Yes, we may do a

self-limiting Mars sortie or two without it, but we'll get no further than that before bogging to a exhausted halt, reaching an invisible, unnamed, unidentified ceiling we'll soon accept.

Congress would no more let NASA doodle with rotating environments than it will let the Agency plan a lunar outpost or Mars expedition. Our manned aspirations have to be kept in check, satisfied with more affordable low Earth orbital tricks and trivia.

How do we make an end run around this conspiracy? The answer is clear. We must encourage commercial demonstration of artificial gravity. After all, even in Earth-fringe space, the ultimate economic bonanza stands to come from Tourism, and orbitels offering artificial gravity, of whatever level, will be much more popular than those that do not.

Meanwhile, there is strong enthusiasm among space-activists and government station supporters alike for allowing commercial activity at Alpha, much as the Space Frontier Foundation's if-you-can't-beat-'em-join-'em "Alpha Town" proposal has outlined. Such an Open Station policy might see the incorporation of commercially financed and operated laboratories, habitats, even compact picture studios and hotel modules in and around Alpha. Here too there is room for an independent coorbital manned rotating facility flying in formation with Alpha. Or, such a facility could be put up in its own, perhaps more equatorial orbit, serving commercially run industrial laboratories, tourism, or both.

Instead of leaving such developments to chance, however, space activists ought to begin now to brainstorm how we could put together an attractive enough "X-prize" purse to ensure that the realization of the first such facility comes sooner rather than latter. The stakes are high. The demonstration of physiologically acceptable artificial gravity stands to blow the lid off human aspirations, which media Science Fiction popularity notwithstanding, is at an effectively contraceptive low. <PK>

### MMM #113 - March 1998

**How we man our space ships to make the most of a mass-constrained mission is clearly a "Space Transportation" issue**

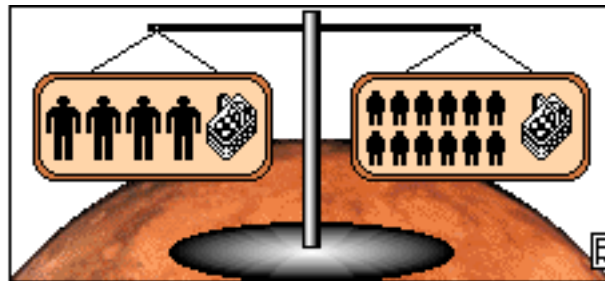

### **Bold Tack in Casting the 1st Mars Crew**

The obvious choice is to pick a crew of healthy males representative of participating nations. There could hardly be a more striking instance of the obvious tack being "dead wrong". Every aspect of the Mars mission can be designed so that brains are everything, brawn irrelevant. We can send more "Little People" with the same supplies and thus accomplish much more mission for our precious bucks. See "More to Mars" below.

## **"More to Mars"**

**Sending 12 men to Mars for the price of 4, or 24 for the price of 8**

**A Radical First Exploration Mission Plan that Should Not be So Lightly Dismissed**

By Peter Kokh

Some years ago Robert Zubrin first showed us how to get much more Mars mission for our buck, in his "Mars Direct" mission plan proposal. We could make the fuel for the Earth-return leg on Mars itself. In contrast, bringing that fuel along with us to Mars would either mean much heavier and more expensive ships, or less equipment to use on Mars, or both.

Now it is time to show that there is a Mars Direct “compatible” mission plan option that could double or triple of the size of the crew – virtually for free – resulting in a first Mars exploration mission with two to three times as much productivity. We call this the **“More to Mars”** mission architecture.

All previous Mars mission plans assume without examination that crew personnel would be selected according to established NASA standards in all respects. Built into these standards is a self-hidden visceral chauvinism that does not let us examine other options, nor even suspect they exist. But in looking a better way to do Mars, this hidden parameter deserves as much attention as any other.

Five years ago, in MMM # 64 April ‘93 in our annual “World Watch” by AFD\* News Service (\* April Fools Day), we ran the following “new story.”



BOULDER, COLORADO: Pygmies and Dwarfs should crew our first exploratory missions to Mars say Doctors Erin Keebler and Tung Yhn Tshieq of the Willy Ley Institute in a report to the National Space Council which they will present at next month’s Case For Mars V Conference in Boulder, CO.

Pygmies and Dwarfs, or Little People as they are now more commonly called, have greatly diminished body mass but fully normal brain size and intelligence. The Mars Mission, they say, can easily be engineered so that brains count for almost everything, brawn for next to nothing. A crew with a combined body mass 25% that of the average astronaut crew of the same number would have a tremendous advantage in two ways. First the crew would need only a weight-proportionate amount of consumables: food, water, fresh air reserves.

Second, while the mass and volume of needed spaceship systems and work stations would remain unchanged, the size, volume, and associated mass of both private and common quarters and walk space could be proportionately reduced. Keebler and Tshieq contend that for otherwise identical missions, one crewed by Little People and designed to be so, would have a fueled launch weight 40% less than one planned for full-size crew members.

This savings can either be reflected in a cheaper, quicker mission, or “cashed in” for extra payload and a longer duration stay on Mars, or for a larger crew. This becomes an attractive win-win-win situation.

The only drawback, the authors admit, is the need to sell the idea to a public that has not ever really accepted either Pygmies or Little People as real people. For individual space supporters, the vicarious pleasure of identifying with our pioneers and explorers is a big element and the choice of so ‘unrepresentative’ a crew could demand an overdue attitude shift.

#### **AFD News Service**

In fact, we were dead serious about this proposal. Yet the disheartening lack of subsequent feedback to this piece only served to show how most readers apparently took it as a joke. Yes, a sad joke on them (on you, if the shoe fits!) The hint not taken five years ago, it is now time to declare ownership of this idea and to publish it anew. This is one of those times, dear reader, to either lead, follow, or get out of the way.

As pointed out in our “tongue-in-cheek” AFD story, the substantial weight savings from selecting substantially smaller humans of undiminished capacities and abilities can be “spent” in three ways:

- **Less massive Mars ships, same size crew, mission**
- **Same size ships, more consumables, longer stay**
- **Same size ships, larger crew, larger task load**

If the cost of the first Mars mission is a major political stumbling block, the same size “ground mission” can be achieved with a smaller rocket and less fuel – at substantial cost savings.

If the government(s) has (have) accepted conventional costing, what we get for that price can be doubled or tripled by either remaining option.

The objections sure to arise to such a plan are the following, neither of them defensible:

- “Subsize humans have inferior intellects and lesser technical and manual abilities”
- “The public will never identify with these “toy”- sized humans and thus lose interest.”

The first objection is truly facetious. There is plenty of time before the first Mars mission (20 years or more) to identify now dwarf and/or Pygmy individuals with the sufficient aptitude, and then to educate and train them from early youth to perform as outstandingly as any more advantaged candidates.

The second objection is reminiscent of racist objections to the introduction of blacks into the major sports. Sports history in the past half century gives this thesis the lie. The public willingly and very quickly takes to its heart whoever performs in outstanding fashion. We would sell the public short, perhaps to disguise hidden unexamined attitudes in ourselves.

I am not suggesting here that Mars be settled exclusively with diminutive individuals, only that making our initial exploration crew selection from their ranks could be the smartest thing we can do.

In time, improved transportation options will make emigration to Mars affordable to individuals of more common-place stature and body mass. "The" important thing, however, is to break the ice on Mars, and to do as much pioneer scouting and pave-the-way scientific investigation as possible in one shot given the money available, so as to lead to the opening of the Mars Frontier in the timeliest fashion possible.

### **"More to Mars" is our best chance to make the most of what may be a solitary opportunity**

The purse-holders of the world may not pay for a "second Mars Exploration Mission", whether or not additional missions have been planned as part of a total exploration package.

**The one thing that is vitally important is to accomplish all the exploratory and investigative tasks necessary to pave the way for the opening of the Mars Frontier to settlement in the first mission, lest we get no follow up opportunities.**

Whoever thinks that this is not important, has learned nothing from the politics of Apollo. If we do get the chance to send humans to Mars, it may very well be a solitary chance. "More to Mars" is our best chance to make the most of it.

I urge the prospace and pro-Mars communities to take the suggestion as seriously as it is meant, and to constructively brainstorm it further. "More to Mars" is a second watershed in the history of Mars Mission Planning. In the end, through our decisions, we shall deserve what we shall get - as always.

In the process, Little People and/or Pygmies could earn lasting and long overdue respect. Just as their outstanding participation in the performing arts and major sports has won Afro-Americans wide-spread and genuine, if limited respect in today's world, a successful mission to Mars crewed by more diminutive persons will do much to erode the major cultural barriers that these populations now face.

In the end, we must ask ourselves that age-old question:

**"Is it better to be on top of a small hill, or half way up a tall mountain?"**

In becoming all that man can be, it is vital that we employ all the varied talents that are out our disposal. Every time we collectively exclude full participation by a minority population, we self-betrayingly choose "the smaller hill". Dwarfism may be one of humanity's infrequent and most unsuspected talents. A successful one-shot Mars-opening mission lies in the balance.

**Three or more millions of years ago, 3 foot tall proto-hominids scouted the way for the human rise to ascendancy on our home planet.**

Does it not seem poetically fitting that a "race" of little scouts turn the trick once again - this time on Mars?

<PK>

# Dwarfs & Pygmies

## **DWARFS & PYGMIES - Just the facts, please!**

By Peter Kokh

**Dwarfs** are not a race. "Dwarfism" is a nonhereditary genetic condition found among all races. Children of dwarfs who marry are usually of "normal stature". Thus dwarfs are "where you find them". Intelligence and manual dexterity are unaffected. While the "supply" is smaller in terms of numbers, so is average height (less than 3 ft/1 meter) and weight (30-45 lbs.)

**Pygmies** are members of two "races", the

- 150,000 Negrillos of central Africa, and approximately
- 35,000 Negritos of Southeast Asia and Oceania.



The former average a half foot shorter (4'–4'8") than the latter (4'6" to 5"). Both these populations are more "norm-ally proportioned" than are "dwarfs", and they are heavier: 60–80 lbs and 80–100 lbs respectively.

#### **The Upshot for a "More to Mars" Mission**

- Interior habitat configurations can be made more compact, starting with personal sleeping cubicles, elbow room at work stations, etc.
- Shifts and hot-racking will stretch common spaces, and multiply the in-flight work that gets done.
- Crew rovers can be downsized, making room for twice as many.
- The Mars outpost could be "bigger" staff wise, or we could have outlying tended camps to support more far-ranging exploration and prospecting.
- The list of talents and abilities represented could be doubled, or even tripled.
- The physical mission will be designed to call for hands and brains, not muscles, and there will be more of those.
- In "More to Mars" a first mission could achieve the goals of the first three "conventionally-manned" missions.

**Its a win-win-win situation.**

### **The Essence of the Frontier: "Readiness to Reinvent Everything" (including Space Transportation)**

**MMM #115 – May 1998**

## **High Sky Aircraft for Venus**

By Peter Kokh

#### **JOB DESCRIPTION**

If we are going to have any number of science station and industrial aerostat hamlets in "the high skies" over Venus, we'll need reliable, easily kept up, worry-free, locally co-manufactured<sup>1</sup> means of transporting people and cargo in between. That's a mouthful of design constraints. Can we deliver?

With the surface off limits to casual ventures, aerial transit is it. And none of our Veneran aircraft will be "landing" or "taking off". They will be "arriving" and "departing" — from midair docking gates.

Craft suited for such purposes may have very limited ability to cope with the greater pressures and heat levels of successively lower layers of the atmosphere. It would seem essential to design into them passive fail-safe buoyancy systems to prevent such misadventures.

#### **FUEL & ENGINES**

Methanox (methane/oxygen) is a serviceable fuel combination for both reciprocating prop engines and for rockets. Most importantly, both fuel and oxidizer can be processed on Venus from the atmosphere where its exhaust will return it in the form of the original ingredients.

As landing is not an option in distress situations, some form of back-up power for electric taxi props would be prudent. Another option, however, is to have the entire upper surface of the craft serve as a rectenna for guide-beam slaved Solar Power Satellite microwave transmissions. Such systems, it'd seem, would be pioneered on Earth long before we'll need them on Venus, and by then be a stock item.

Where sprint-rescue speeds are not needed, propeller-driven craft promise the greatest fuel efficiency with adequate speeds as well as superior low speed performance for dock approaches and departures. Aircraft can safely fly at the 1 ATM aerostat level but need climbing ability to reach thinner air for more efficient cruising.

While fuel tanks should be ample for long range and extended cruising and bad weather and other emergency situations, again because landing is not an option, Veneran aircraft should have midair refueling capability. Midair docking capacity for exchanges of crew, passengers, and cargo would be an invaluable advantage, brining enormous flexibility.

To avoid construction of aerial runways that offering surface friction to assist braking and deceleration and provide a platform for acceleration to lift speeds, aircraft should either be buoyant or have some sort of Harrier or other type VTOL or hovering capacity. This would help in midair docking.

### **CONSTRUCTION & COMPONENTS**

Lightweight Kevlar components, manufactured in Veneran high sky facilities, will provide greater strength and lessen the weight to be managed in maintaining lift, buoyancy, and hovering ability. Small complex subassemblies (navigation avionics , other electronics, control & communication systems, air-tight docking ports, etc.) can be imported from Earth to mate with Venus-made fuselages, wings, fuel tanks, cabin interiors, and other items designed for ease of on site manufacture and assembly.

A whole family of Veneran aircraft will be needed: small crew transports, smaller and larger passenger craft, craft dedicated for cargo, fast sprint rescue and response craft. Maintaining a “family” resemblance along with the maximum percentage of interchangeable parts will be of compelling benefit.

### **FAIL-SAFE & JUST-IN-TIME LIGHTER THAN AIR**

Obviously, the dirigible is one viable option along with other possible lighter-than-air architectures (there is now a renaissance in interest along with increased exploration of new design options). But full-time partial buoyancy and buoyancy-on-demand with fail-safe, dead man deployment systems will also work while allowing more streamlined designs and faster cruising speeds.

Hydrogen-filled bags that passively inflate whenever certain impeding conditions degrade will make the High Skies safe for all Venerans to fly. These conditions include minimum speed, maximum desirable or tolerable air density and/or temperatures, as well as certain internal conditions (loss of fuel, power, active crew).

To more efficiently negotiate different altitude ranges as well as variable speeds. wing and/or lift surface designs that allow the loading to be varied are a downrange design consideration.

### **SPECIAL DUTY CRAFT FOR SURFACE EXPLORATION**

On Earth, we have built oceanic submersibles that have withstood over 1,000 ATMs of external hull pressure. So it is temperature, not pressure, that looms as the most challenging hurdle facing would be surface exploration craft, including VTOL aircraft and wheeled gondola cabins lowered and lifted by collapse and store balloons. As an interim measure, mid-altitude aircraft could lower retrievable instrumented science/communications packages on tethers.

### **COMMUNICATIONS**

How serviceable line-of-sight radio communications will be, is unknown. With less of a magnetosphere, solar or cosmic noise could be a big problem on Venus. Satellites could offer GPS navigation assist as well as communications relay. But so could heat and pressure-hardened surface relay stations.

On this as on other challenges above, the old adage applies. “Where there is a will, (and no defeatist attitude!) there’s a way.” “High Skies!” <MMM>

**MMM #121 - December 1998**

## **No air = No airplanes = No airports ! = The “Interchute”**

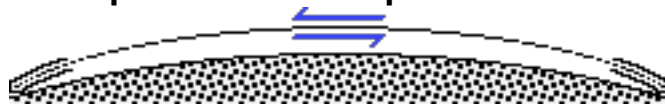

We can't fly around the Moon! Perhaps - yet maybe!

The “Interchute” uses a fixed pair of mass driver/catchers to fling passenger “coach cans” back & forth between pairs of settlements where traffic warrants. **See below.**



LUNAR INTER-CITY "FLIGHTS" VIA THE INTERCHUTE By Peter

Here on Earth, it would be hard to imagine what modern civilization would be like, if for some reason, there were no aviation, no airplanes, no travel swiftly than high speed rail. Those who romanticize about future settlement civilization on Mars have been greatly encouraged by the fact that Mars thin air could support aviation.

Takeoff/landing speeds would have to be very very high, and some lift assist, perhaps in the form of thick, hydrogen filled wings, might be necessary. Yet if it can become a practical reality, that is an enormous plus for opening a world as vast as all of Earth's continents gathered together. The alternative is either substantial investment in a global ground infrastructure – roads and rail, "R&R" – or a resort to suborbital flights.

Such an alternative – to aviation – is taken for granted by those brainstorming human futures on the airless Moon, the impossible ground-skimming lunar bus of "2001: A Space Odyssey" notwithstanding. We will build limited networks of roads on the Moon, we may have high speed Maglev lines in heavily traveled corridors, and overhead cable car lines elsewhere.

Yet eventually, even through the high lunar vacuum, when and where intersite passenger traffic demand rises high enough, there may be an "aerial" option. If this idea proves practical it will be because the Moon lacks an effective atmosphere, turning a "liability" into an asset, in true pioneering fashion.

More than twenty years after most of us heard of mass drivers and electromagnetic catapults, we are used to the concept of mass drivers as devices that hurtle small pellets of materials into space at bone-and tissue-crushing accelerations. But a number of people have already expanded their vision to include larger diameter, much longer electromagnetic catapults that could hurl passenger cabins into space at accelerations the ordinary person might tolerate. It will take more power to hurtle the larger payloads, but less per drive cell unit owing to the greatly reduced acceleration. The total energy needed per kilogram or ton(ne) will be similar. The rest will all depend on the total traffic tonnage in either case.

Writing in the Artemis Data Book\*, Greg R. Bennett explains: "A man-rated mass driver would be longer, but not significantly more complex. One limited to 3 g's acceleration, designed to escape\*\* from the Earth-Moon system starting at the surface of the Moon would be 63 miles (101 km) long."

\*<http://www.asi.org/adb/02/10/mass-driver-intro.html>

\*\* assuming a total delta V of 8,016 ft/sec (2,443 m/sec), lunar escape velocity from the surface (7,776 ft/sec) plus additional escape velocity (240 ft/sec) to escape Earth's gravity at distance of the Moon. Formula for the length of the mass driver  $S = V^2 / (2 * a)$

An Interchute driver/catcher need not be quite so long; we do not want full orbital velocity, much less escape velocity. But at both ends, it would still be a major piece of infrastructure.

A Caveat here: 3-Gs is quite tolerable for most Earthlings, but it would be 18 times the gravity level to which future Lunans may have become physiologically attuned. Somewhere a tradeoff will have to be made between affordable length of the Interchute installation and the percentage of Lunans who can tolerate a ride. Nonetheless, the idea is an engineering practicality, and this article is based on that.

This transport system demands an extremely high level of precision accuracy, within a centimeter perhaps, after a volley of hundreds, even thousands of kilometers. Anything short (long, off to the right or left) would mean certain vaporizing death on impact at c. 1.5 km/sec. Such precision could never be attained even once, let alone routinely, through an atmosphere of varying pressure and moving fronts. Mars could not support such a system even between its loftiest volcano tops where the air is thinnest.

For such a system to work, there needs to be at least one pair of settlements far enough apart to raise the demand for faster travel between them and with enough potential traffic to pay for the expensive installation. Destinations only a few hundred miles apart might be better, and less expensively served by a Maglev rail system. At the far end of the distance range would be destinations antipodal to one another, at the opposite side of the globe, 3392 miles [5459 km] or about 1 hr flight time apart.

**Examples:**

- Mare Smythii <=> Mare Orientalis
- Mare Imbrium <=> Mare Ingenii
- Aristarchus <=> Tsiolkovsky.

**GROWING A GLOBAL SYSTEM**

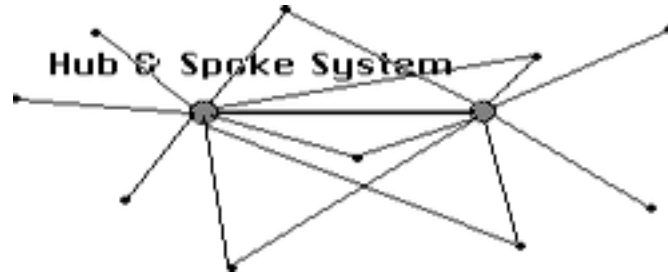

The chutes would come in dedicated pairs. One settlement could have several, connecting it with others around the globe. Given the many-kilometer long length of each chute, a railroad-style "round table" allowing one chute to be alternately aimed at several destinations would be quite impractical. What could be shared between several chutes at an Interchute complex is the charging power source and transit to the host settlement interior.

**THE ROMANCE FACTOR**

On Earth, most rail systems name their individual regular trains (a few use numbers). Who knows what names would be used on various Interchute lines? But here are some suggestions that seem appropriate to the nature of the beast: The Javelin, The Sagittarian, The William Tell, The Arrowsmith, The Bullseye, The Marksman, The Aurora Arrow, The Quivers, Cupid Twins, The Spirit of Port Heinlein, The Spirit of Luna City, The Boomerang, The Retrobullet, Intervolley, Alternatives to "Interchute" might be Flightrail, Skyrail, Sledway, Interballistic, etc.

**The Passenger Coaches**

Interchute coaches are not rockets. They are passive bullets or projectiles. The acceleration and deceleration both take place entirely within the "barrels" of a pair of electromagnetic "cannons" "aimed down each other's throats". Properly set up, there would be no need for "mid course corrections". These "coach cans" are passenger conveyances but not vehicles as such apart from the chutes they ply between, as they are totally passive elements.

**SHORT FLIGHTS – SPARTAN ACCOMMODATIONS**

Interchute travel on the Moon would be very swift, with a maximum of one hour flight times, but in most cases much shorter. As such, accommodations can be rather spartan: no berths, no snacks, maybe even no toilets. All such facilities would be found in the terminal buildings.

**LOADING & UNLOADING PASSENGERS**

Economics (demand for lowest ticket prices) will demand "maximum packing" of the coach cans. An "aislefree" arrangement can be effected by using pre-boarded seating trays that can slide into (and back out of) the Coach Can through an end-installed door-lock.

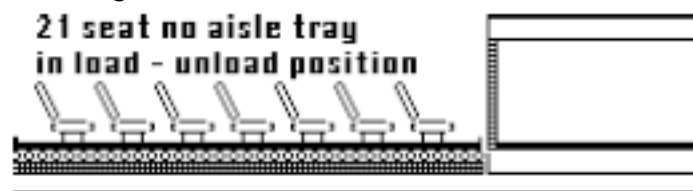

ABOVE: seats entered from side platforms

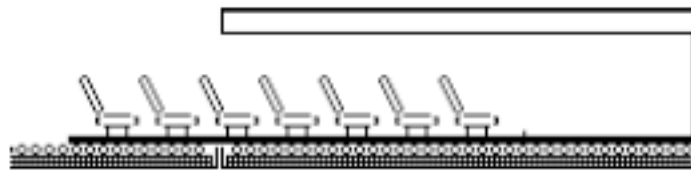

ABOVE: seat tray rolling into "coach can"



ABOVE: "coach can" loaded with no wasted aisle space

Approaching the half way point of the zero-g ballistic coast, the coach can will do a computer controlled precision 180° end-for-end flip to prepare for deceleration within the kilometers long barrel of the catching chute ('g's felt against the back of one's seat just as in acceleration in the equally long barrel of the driving chute).



### FREIGHT USE IN SLACK TIME?

Could an Interchute system be used to ship containerized freight of comparable mass? Between the same pair of chutes, certainly. Plus passenger runs could be used to deliver priority packages on a ballast-needed opportunity basis. But the chutes themselves could not be re-aimed to other destinations.

However, the velocity and length of trajectory can be decreased or increased, by adjusting the electrical power input. This should allow alternative freight distribution terminal chutes conveniently aligned along the same vector or pathway.

### COACH CAN TURNAROUND & CHUTE CAPACITY

The reversible trajectory between a pair of chutes is so narrow that cans traveling in opposite directions between the same pair of chutes could not "pass" in mid flight without colliding head on. If only one coach can is used, its turnaround time plus a pair of flight times will yields the capacity of the system per day. The farther apart the two terminals, the less total flights can be made each day by a coach can.

However, even though cans cannot safely pass in the opposite direction, Interchute capacity can be multiplied by following a series of volleys by a fleet of cans all in one direction by a similar series of return flights. Upon reaching its destination, each can would be shunted onto a siding until its position in the return queue came up. The shorter the interval between volleys, the greater the Interchute capacity.

### ENGINEERING CONSIDERATIONS

- repeat precision accuracy despite load variation
- tolerable accelerations
- long smoothly graded chute runs
- a suitable pair of sites
- fail-safe power nightspan as well as dayspan
- passengers per megawatt
- maximum runs per day (same coach both ways)
- total capacity versus expected growth of demand

### SITE CONSIDERATIONS

The flight path of the chute cans starts off and ends tangential to the lunar surface. All that is needed is enough initial elevation to provide ground and passing vehicle clearance along the exit and entrance glideslopes. Inclination to the level of the surface need be negligible. (In this respect, my title and first page artwork are misleading.) Gentle crater rim slopes are not strictly needed, even if handy. Obviously, it will be harder to find optimum sites in the more rugged highland areas than in the comparatively flat maria or lava plain "seas".

### **PROFIT CONSIDERATIONS**

The first Interchute will be built between the pair of settlements projected to generate the highest traffic demand, combining passengers and priority containerized cargo.

As the system begins to run smoothly and becomes accepted and chute travel becomes routine, the cost of building additional interchute pairs linking one or both of the original pair to other sites will come down. The Interchute might remain a monopoly if the company has the capital to expand routes to include other growing lunar sites. Or it might be duplicated by other companies with the capital. Rival parallel Interchutes between the same towns are possible if demand increases beyond capacity of the original system.

Two towns of a million people a thousand miles apart a hundred years ago might not have had enough traffic between them to justify an Interchute even if it could have been built on Earth. But the amount of economic interdependence and percentage of consumption that rests on trade and traffic has been steadily increasing in our globalizing economy.

On the Moon, once there are two settlements of rival size, interdependent traffic between them will be relatively strong no matter how far apart they are (3,392 miles max, one half lunar circumference.) And there will be no real alternative, aviation being out of consideration.

### **NOT FOR EVERYWHERE & NOT SOON**

The Interchute is a much more specialized transportation system than are railroads. Nor would realization of this dream be a down payment on "general aviation" in any sort of form realizable on the Moon:

1. Interchute loops, of whatever length and frequency of use, will require a very large capital investment.
2. The further two potential terminals are apart in terms of real alternative road travel time, the greater the time savings and the stronger the incentive to build an Interchute.
3. Towns a few hours apart by good highway would not be good candidates no matter how much mutual traffic they generated. High speed rail (see MM Review #13, AUG 13, pp. 9-15 "Lunar Railroads") or Maglev would be the Choice.

[http://www.moonsociety.org/publications/mmm\\_papers/rr\\_moon.htm](http://www.moonsociety.org/publications/mmm_papers/rr_moon.htm)

Interchutes will be a travel option on the Moon some generations down the road, when and if the lunar frontier economy fully develops to its full potential, which is considerable. <MMM>

**MMM #122 - February 1999**

**Artemis Project™ Lunar Ascent Vehicle aka the "Space Motorcycle"**

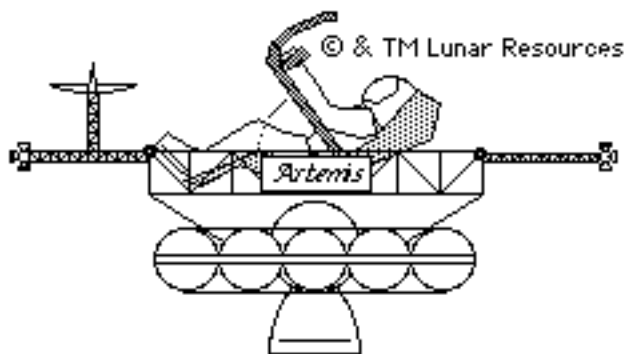

Illustrations by Vik Olliver



**Note: NASA has since met this concept “halfway”**

By reducing the structure lifting off the Moon, and hence minimizing its mass, to the Lunar Lander “airlock” and by thus minimizing the mass returning from the Moon’s surface, the amount of mass and structure that can be left on the Moon is increased by that same amount.

**MMM #124 – April 1999**

**Man-rated Mass Drivers & Mass Catcher to & from Lunar Orbit**

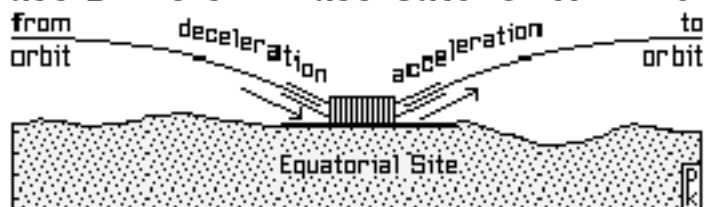

By Peter Kokh

In a previous article [MMM #121 DEC '98, “Lunar Intercity ‘Flights’ via the INTERCHUTE”] we sketched an idea for electromagnetic man-rated mass-driver / mass-catcher pairs to handle high volume inter-settlement passenger traffic on the Moon via an automated suborbital shuttle system. Here we sketch the use of a similar system to get people on and off the Moon cheaply and safely – once an expensive infrastructure is discounted or amortized. As with the suborbital Interchute, this is a trick difficult to match on Mars where atmospheric interference would make it impossible to compensate with enough precision to make it work safely.

Unlike the “Interchute” system in which each electromagnetic cannon will both throw and catch, for to/from orbit traffic, as the directions (to/from) are opposite, not the same, there will need to be two cannons, one doing all the throwing, the other all the catching. It would be convenient to line them up back to back with a passenger terminal building in between. That would make it handy to process a shuttle that has just arrived for the return flight to space. Several parking slips would be needed, as the order of arrival is certain not to be observed in the order of departure.



As traffic at this electromagnetic space port (ESP) grows, more parking slips will have to be added and provision for such expansion should be made in the original design.

Parking is likely in a sky-sheltered area exposed to the vacuum. Nominal service can then be done in soft suits. Pressurized garages would be available for more labor-demanding service. Since the various craft would need to have the same diameter and cylindrical cross-section, this would make a standard garage slip-lock a sure thing.

The stakes are high. It would require corresponding space infrastructure, either in a precisely positioned orbit and oriented orbit, or near L1 or L2 Earth-Moon Lagrange points, whichever is the more stable and forgiving. It would also require onboard propulsion to taxi to the shifting station from its driver-catcher trajectory path and vice versa.

- If the space transfer station is to be at L2, behind the Moon, the ESP would need to be sited on the Nearside Equator.
- If the space station is at L1, between Earth and the Moon, the ESP would have to be built on the Farside Equator in an intercrater plain – there are no maria smack on the Farside equator (a mare fill area in Aitken crater is the closest match), unlike the Nearside situation where there is an abundance of potential sites.
- Either option poses problems for the maintenance of the priceless Farside radio silence needed by radio astronomers and the S.E.T.I. Project. It would be near impossible to reproduce this radio silence anywhere else in the Solar System

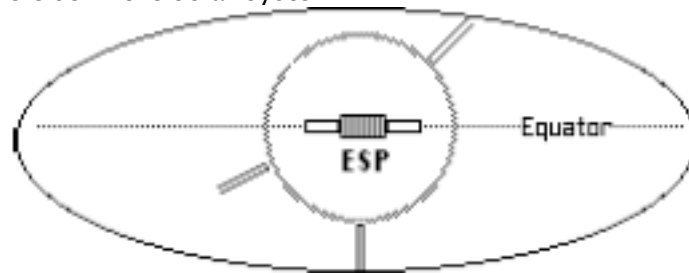

A potential disadvantage is that a driver-catcher must be on the equator – precisely so – whether handy or not to the locations of existing settlements. On the other hand, such an installation would be an economic boon to any settlements nearby or surely give rise to one if there were not.

The installation of such an ESP facility would speed up of the flow of immigration to the Lunar Frontier Territory (or Republic) as well as lower the cost per individual. A same cross-section, same total weight range cargo hold craft would greatly lower the cost of importing and exporting large items. In both ways, the inauguration of such a facility would mark a threshold of significant expansion of the lunar economy in total trade volume, tourist volume, and settled population. Inauguration of service will mark the attainment of a critical mass that changes the prospectus of the lunar frontier substantially.

Speed and momentum would differ only by a few percent from that of the proposed suborbital Interchute systems. So the length of the passenger-rated E-Mag cannons need be only slightly longer.

There could conceivably be more than one such E-Mag spaceport, if the first was not sufficiently handy to all inhabited areas of the Moon. But the original cannons may not need to be doubled or tripled or more at the same site for a long time. Loads could probably be received and sent at very short intervals with streamlining of the off-loading, shunting, and onloading operations, allowing perhaps hundreds of flights each way each day.

Instead of duplicating the Electromagnetic Space Port at multiple locations around the Moon, it would be logical, at least early on, to make it THE hub of a global Interchute system. Both applications of passenger-rated electromagnetic driver-catchers seem destined for realization in tandem. One need not wait upon the other in this case, so long as the real estate and infrastructure needs of the other was considered in the planning of whichever comes first.

And no, there is no way the flight paths of Cans coming from and bound for orbit would infringe on the paths



of incoming and outgoing Interchute flights. That is especially guaranteed by making the same general location the hub for both to/from orbit traffic and for inter-settlement flights. The Interchute cannons might be best arrayed in a manner concentric to the ESP. Interchutes would radiate out from the center but only in the directions called for by the location of high traffic generating locations. The Interchute Hub would be no more symmetric than the geographical array of settlements across the lunar globe.

Such a Hub would deserve a special name like Port Luna, Lunaport, Lunar Global Gateway, Gateway Luna, Moon Central, Union Gateway, etc. It could just as easily be named after an individual prominent in the Lunar Republic's prehistory or early years, like Heinlein, or somebody yet unknown or even unborn.

Even if there were originally no nearby settlement or even any [other] economic reason to settle the Central Hub area, the steady rise in the transient population passing through it, and of the permanent population needed to service their needs, would give rise in time to a major city. Its primary industry would be running and servicing the Central Hub complex and all the people who pass through it.

Because the Central Hub will quickly become the gathering place on the Moon, it may well also become the

entertainment, diversion and escape center, and be a magnet for such developments as:

- Global Trade Center and Export Showcase
- Major convention facilities and hotels
- Magnet shopping mall
- Duty-free or duty-low import shops
- Magnet specialty museums
- Magnet amusement park
- Groupie tourist traps cashing in on the traffic
- Headquarters for lunar excursion companies
- Headquarters for many all-Luna organizations
- Cluster of Earth nation and other Embassies
- Mars and Asteroid frontier recruiting agencies
- Network Broadcast/Telecast Center
- A major university
- A major medical center

[See MMM # 56 JUN 92, pp. 3-4, "Harbor & Town" republished in MMMC #10]

Other magnets needing maximum traffic to justify their construction or development costs will follow. However big the Hub Center gets, it will be the most homogenized melting pot on the globe, the least "typical", most cosmopolitan frontier city.

In the wake of such a development, major conventional space ports may wane, although there will always be a need for such ports to accept and send cargoes and groups of people that the totally containerized Central Hub operations cannot handle as well as the space equivalent of "general aviation." In turn, there will always be mineralogical, industrial, geological, geographic, scenic and other reasons for preestablished centers in other areas of the Moon to continue to thrive.

More, a Central Interchute Hub need not preclude regional Interchute hubs.

#### **Revenues:**

Paying the price tag of an ESP Hub Installation can be handled through Space-line can arrival, departure, parking and transfer (gate) fees, ticket counter leases, corporate hanger leases and user fees, and other "anchor tenant" contracts for companies wanting to provide service to the traffic (hotels, land excursion companies, merchants, outfitters, etc.).

The installation would not be built except under the expectation that it would be profitable within a given time frame. The greater the momentum slope of lunar economic development and immigration, the sooner the Electromagnetic

Space Port is likely to become a reality. Running the operation could be the job of a Port Authority type entity with a Board of Directors responsible to the Lunar Frontier Government. The venerable "Port of New York Authority" might serve as a model, appropriate modifications and corrections being made, of course.

Others have thought of such a system in general terms. It is an idea that comes naturally enough, given familiarity with the concept of lunar mass drivers publicized by Gerard O'Neill. <MMM>

## A Reusable Lunar ferry – A Flexible Design Concept

© 1990 John K. Strickland, Jr – with permission

To save vehicle development costs, one basic type of lunar ferry (possibly also used for LEO – Lunar Orbit transit without landing gear) should be developed. The modular vehicle should be able to:

1. land cargo for the base and return to lunar orbit without refueling (before the oxygen plant is running). In this case, extra oxygen tanks replace part of the available cargo pallet space.
2. NORMAL OPERATION (after the oxygen plant is running). In this case the ferry refuels Hydrogen in lunar orbit, lands, refuels Oxygen from the base, returns to lunar orbit where the cycle continues. Oxygen received at the base is used to take off, and also to land. Hydrogen received in orbit is used to land, and also to take off.
3. Land extra heavy cargo by being linked together in tandem and operating at least 2 or 4 ferries as a single unit. Ferries should be able to be linked together without a lot of EVA work, and should use active mechanical linkages to lock the vehicles together.
4. Carry LOX back into Lunar orbit for use by the LEO–lunar vehicles.
5. 1 + 3 to land heavy cargo before the oxygen plant is ready.

If a non-reusable ferry vehicle is developed first, the design and development costs would be doubled over the cost of a single design. In addition, the expendable ferries would not be available for reuse, parts, or for emergencies. A case could be made for building a few large expendable ferries for landing large items for the base, but using a modular ferry design removes this requirement.

An analysis of maximum required cargo weights and dimensions would allow definition of the optimum ferry size. An initial design decision must be whether 2, 4, or more ferries can be linked. If the individual vehicles are considered as being 4 sided, a 2 ferry system involves a linkage on 1 side of each vehicle, a 4 ferry system means 2 adjoining sides linked per vehicle, and so forth.

### **Critical questions for such a design would include:**

- redundant systems in case the propulsion for a single ferry failed (making composite vehicle attitude control while boosting impossible).
- Linking the electronic controls for each ferry into the composite.
- either designing the landing legs not to interfere with each other, or to allow some central legs to be removed temporarily. (This might require an unacceptably high amount of EVA time and ).

### **One solution might be entire modular vehicle sides including legs.**

- EVA time analysis for linking and unlinking vehicles, and ways to reduce this to an absolute minimum.
- Having a private company design, build, and operate the lunar ferry (as a space transportation service) is strongly recommended.
- Such a ferry design would save development costs and increase the flexibility of the system.
- It would increase the maximum unit payload capacity of the system and the total number of vehicles available.
- It would support early use of lunar derived LOX for ferry fuel. <JS>

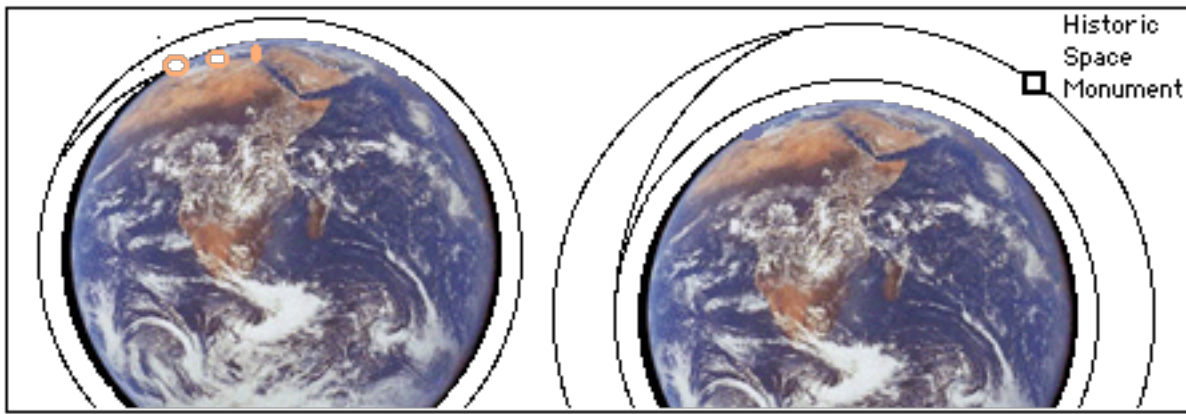

### What to do with MIR?

There would seem to be two ways to remove MIR from service: L) a cheap but dirty deorbit mission with unknown damage to property and people on the surface. R) a more expensive major boost to a significantly higher parking orbit, as a Space Historical Monument.

## The MIR Station World Space Monument A Better Option for Decommissioning

By Peter Kokh

How many times have we heard “if your only tool is a hammer, every problem looks like a nail!” NASA is committed to seeing the MiR Station removed from service. But need removal from service necessarily mean removal from orbit?

To be sure, MIR will not stay in orbit by itself. At its altitude range, there is still enough wisps of atmosphere to continually drag down Mir’s orbit to the point where it will eventually, controlled or not controlled, partially incinerate in the atmosphere, its remnants crashing into the ocean -- or onto land. It takes money to keep boosting up Mir’s orbit periodically. So it would seem that to decommission Mir must mean either to allow its orbit to decay in uncontrolled fashion, or to deliberately accelerate the process in a way we can control it.

### A “controlled de-orbit” has two costs:

- a Progress freighter bringing the fuel for the de-orbit burn
- the impossible to estimate costs of the crash landing in inhabited areas of the many fragments too heavy and dense to burn up in the atmosphere

This second cost is the sleeper, as no one can estimate it in advance. If we take a median of optimistic and pessimistic assessments of the damage to property and citizens, and add it to the costs of the Progress freighter de-orbit refueling mission, we come up with a higher dollar figure which should send us looking for alternatives.

We propose instead, that a more expensive refueling mission boost Mir’s orbit up to an altitude where it would remain safe for generations. It can then be given the status of a World Space Historical Site, or Monument. At some future date -- no need to determine that now -- an orbiting Visitor’s Center could be built for students of space history and tourists to visit under careful guidance.

Mir should be seen as a priceless treasure of technology and achievement. That as long as it remains in service, it will be a thorn in NASA’s side should not leave a destructive solution as the only option. It is not to the credit of NASA, or the agency’s leash holders, let alone to the Russian authorities, not to seriously pursue this other option.

Those Russians who object to scuttling Mir are being dismissed as ultra-nationalists and communists. Alas, having lived through McCarthyism once, it is distressing to see it arise anew this way.

We call on all parties to take the time to look at this new option. Especially considering the potentially high cost of the inevitable rain of Mir-debris on property and people, we owe it to ourselves and future generations to take another look.

PK

# Could we have reused the Apollo Capsules, or any part of them?

(As in theory, reusing something is cheaper than replacing it. So the following discussion is very interesting)

An exchange on [artemis-list@asi.org](mailto:artemis-list@asi.org) November 22, 2000

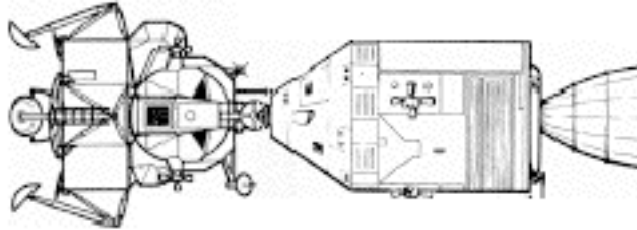

**Gregory R. Bennett** <[grb@asi.org](mailto:grb@asi.org)>

We did not reuse the Apollo capsules, or any part of them. But, could we have?

I was just wondering if there were anything inherent in the design of the Apollo capsule that precluded reusing it. It was a tiny part of the spacecraft, but it did contain a lot of expensive equipment.

I often wonder whether flying a whole new spacecraft is really more safe than using one that has been proven in flight. Perhaps the fact that each capsule went through extensive testing made up for lack of operational experience with the spacecraft, Apollo 13 notwithstanding.

**Wallace A. McClure** <[Wallace.McClure@West.Boeing.com](mailto:Wallace.McClure@West.Boeing.com)>

"The short answer is yes to part of them, or at least some of them could have been refurbished to fly again. I also assume you are using a new Service Module with them. In particular, those used for Earth orbital missions could probably have been reused for Earth orbital missions.

- Structure -- Could have been reused, but you would have to inspect to ensure no sea water intrusion or corrosion (e.g. don't get salt water in the structure, particularly inside the pressure vessel.)
- Thermal Protection System -- This was sized for a direct return reentry from the Moon. Run the numbers and you see the heat load from an Earth orbital reentry was less than 50% of that of a lunar return. The heat shield was not replaceable in sections, but you could have theoretically remachined down the uneven remaining unablated honeycomb and reused it for an Earth orbital mission. (With inspections, of course!) Theoretically, you could replace the entire ablative reentry shield. But that was never considered.
- Avionics -- Reusable, yes, with replacement and testing of batteries, etc.
- ECLSS -- Most of the ECLSS was in the service module.  
You would have to renew the ECLSS LiOH [lithium hydroxide] and it was reusable. You would have to replace the connections to the service module.
- ACS -- The CM ACS was really only used post SM separation (and primarily for roll control). At a minimum, you would have to clean and replace all the burst disks, etc. But from a first look, you could probably reuse the tanks, valves, engines etc.
- Parachutes, etc. -- Definitely replace them. They were rampacked and certified for only one use. Also the pyros, etc. would need to be replaced.
- Soft Goods -- Inspect and replace seals, rubber gaskets, etc. You do need to look at them.
- Of course, if any vehicle was used outside of the expected operational conditions, reuse might not be possible -- land landing, hot-hot reentry, sea water sloshing around inside for weeks, etc. But for a run-of-the-mill Earth orbital mission -- probably most of it could have been refurbished and reused.

**Dale Gray** <[dalegray@micron.net](mailto:dalegray@micron.net)>

As I understand, the capsules evolved over time even after Apollo 8. Reusing an old capsule would be to take a step backward in safety, performance, mass. **The returned capsules were far more valuable as national treasures, complete and untouched than any conceived salvage part or in whole.**

**Andrew Newstead** <[A.Newstead@pop3.appleonline.net](mailto:A.Newstead@pop3.appleonline.net)>

I believe the Apollo 14 docking probe was reused with one of the Skylab Apollos or the ASTP Apollo. Because of the difficulties with it during the flight of Apollo 14, it was brought back for engi-

neering analysis, which found nothing wrong with it and it was reused as an economy measure. It gave trouble again when reflown, so go figure!

Ben Huset <[benhusset@skyling.net](mailto:benhusset@skyling.net)>” Today, all the Soyuz capsules have been used only once.

# Shuttle Conestoga,

## SpaceHab, & Artemis Moonbase™: a Mission Design Dialog

By Peter Kokh

From MMM #51, December 1991, “Hybrid Rigid-Inflatables in Space”

At the 1990 Space Development Conference in Anaheim, California, then deputy NASA Administrator, J.R. Thompson, shared with us some of his surprisingly unfettered thoughts about real near-term possibilities. Thompson felt there was no reason why the Shuttle orbiter, refueled in orbit, couldn't make a non-landing round trip out to the Moon and back. He imagined the Payload Bay outfitted with a folded inflatable structure. Once in cruise mode, the payload bay doors would open, the inflatable would be filled with air, and the Shuttle would take on a distinctively conestoga-like appearance, reminiscent of a bumper sticker design produced by Peoria L5 some years back.



Such a mission could be flown in low Earth orbit, but would be riskier (to the inflatable envelope) owing to the high concentration of accumulating space debris. Whether in orbit, or solely on the portion of the circumlunar cruise that lay safely beyond the debris zone, such an inflated orbiter mission would be enhanced if the bed of the payload bay were packed with space-lab type modules to structure the use of the volume supplied by the inflatable volume.

### Advantages & Drawbacks of this Scenario

There seem to be three advantages:

- those making the Lunar Overflight Loop would not have to transfer vehicles at any part of the flight
- the tourist cabin in the Shuttle Bay can borrow communications and life support from the shuttle
- having the winged Shuttle as a carrier allows direct return to Earth with atmospheric braking and without a depot stop in low Earth orbit.

### The drawbacks seem to be more considerable:

- Lugging along the entire 80 ton shuttle greatly multiplies the amount of fuel needed to make the translunar orbit injection even if there is to be a direct high-velocity return to Earth with atmospheric braking.
- To bring along this much fuel requires bringing an External Tank to orbit and perhaps a number of dedicated fuel shipments, along with in-orbit cryogenic refueling, something we have never tried (there is a first time for everything!)

### A more sensible proposal

If the passenger cabin has to make both the ride up from Earth, and the return to the Earth's surface in a Shuttle payload bay, it could still be made self-sufficient in communications and life-support. If so, it could be removed from the payload bay in orbit by the Shuttle's manipulator arm. Then it can be mated with a much smaller 2 stage booster for the lunar loop trip, the second stage responsible for braking the cabin back in a low Earth orbit where it can be recaptured by the Shuttle.

This proposal would require only off-the-shelf components and is basically identical with the Artemis Project™ LTV stack. That is, we can make such a passenger cabin out of a specially designed gang of Space Hab modules.

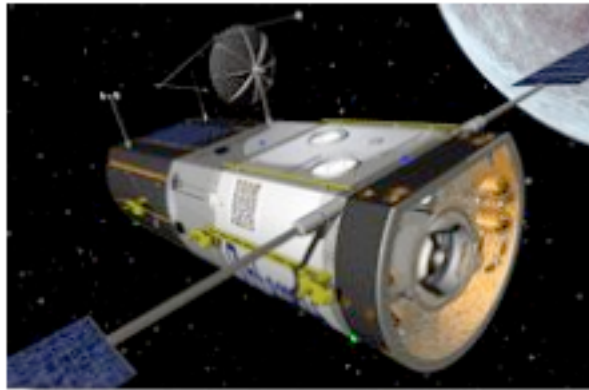

At the time that J.R. Thompson made his proposal, Spacehab, a pressurized module that rides in the Shuttle payload bay, was itself just a dream on paper. SpaceHab is now a reality and has made many shuttle flights. There are even “ganged” versions with double (and potentially triple or more) the interior space.

Modifications would have to be made to both the interior and exterior of the SpaceHab modules, of course. An

ASI Design Team is looking into this. The SpaceHab mission would do three things:

- prime the pump for Lunar Overflight tour enthusiasm
- loosen the purse strings for needed additional capital for space module entrepreneurs like Bigelow Aerospace
- shed advance light on redesign needs. It would seem to be highly advantageous to the Artemis Project™ to plan the initial test flight of its Moonbase “stack” as a paying tourist venture.\
- Tourist dollars as well as a contract from Bigelow to test various items, features, and services would help defray the cost of such a test flight.
- Public stay-at-home armchair enthusiasm of the pioneer lunar overflight passenger excursion will:
- spill over into enthusiasm for the Moonbase project itself
- build momentum for sales of “edutainment” products both from this initial overflight tour and from the ensuing moonbase mission.

Thus for the Lunar Resources Company (TLRC, the owner of the Artemis Project™ and Artemis Moonbase@ trademarks and conductor of the Projects) to conduct the test flight of the Moonbase stack as a tourist offering would seem to be a win-win situation with few drawbacks. <MMM>

## **“Deadman’s” Spacesuit Thruster Pack with Fail-Safe “Homing” Capabilities EVA Assured Safety without Tethers**

By Peter Kokh

Astronauts in space suits gliding off into oblivion and certain death is a standby of science fiction film melodramas. The tether breaks – or is “cut” – or a hero-martyr disconnects the tether to retrieve something just out of reach. The umbilical tether has been part of Extra-Vehicular Activity [EVA] ever since Alexei Leonov took the first plunge out the airlock in March of 1965 (Voshkod 2), beating Edward White’s solo (Gemini 4) by six weeks.

While eventually, NASA would test the MMU “floating free” Manned Maneuvering Unit backpack in nine untethered EVAs in 1984 (seven of them from the ill-fated Challenger orbiter), the umbilical safety of the tether has been a hard cord to cut. With the MMU, there was always the danger of an accidental overthrust, putting the wearer on a trajectory from which there was no recovery or return.

That was seventeen years ago, already! Computers have come a long way since then. There would seem to be no reason why smart “override” controls could not be built in, keeping tabs of changes in momentum and vector and distance as well as remaining thruster fuel, the suit would auto-

matically override manual controls whenever the delta V needed to return to the airlock approached the limits of remaining fuel. The suit could also have a “deadman’s” control feature that activates automatic return if sensors detected any decrease in suit pressure or prolonged inactivity. Homing beacons on in range airlocks would be part of the system.

Such a “smart” MMU would enable safe and worry-free EVA by more than one person without the risk of mutual entanglement. The annoying problem of entangled cords is precisely what has made “cordless” power tools so popular in the work place!

While useful for construction and inspections and other work duties, our point is that such a suit would allow “frolicking” in space for the very first time! Frolicking, and unleashed sports. Perhaps even “Extreme” Space Sports. At first, there might be only one model, especially for construction, repair, and industrial purposes. But once there are enough people working and living in space to increase the demand for a variety of challenging sport activities, manufacturers could start producing “sport MMUs” with special “handling” and “maneuvering” capabilities. Range, in terms of Delta-V units, along with acceleration, will be as important to space athletes as megahertz and gigabytes are to computer buyers.

But as long as “all there is to do” is to go for an aimless joyride through landmark-free empty space, “free thrusting” will be little more than a short-lived fad. Development of a real and growing market will go hand in hand with the parallel development of EVA team sports and games, even “track & field” type individual events in which one goes for a new “record.”

The start could be something simple like a rally around an ISS management sanctioned course around the periphery of the station with its many modules, struts, solar panels -- in and out of plane. To minimize accidents, the smart suit would have to have proximity sensors that would override manual controls in time to take evasive action. The idea, of course, would be to get as close as one could to a rally point without triggering the override as that might re-vector you out of the competition in a direction not of your choosing! If a game, sport, or event does not challenge one’s skills, what good is it?

An alternative would be a co-orbiting rally “course” with a set of station-keeping market buoys. Their mutual positions could even be randomized from one event to another, the proper sequence indicated by beacon color perhaps. Space suit “team sports” could come in time. Touch Space Ball? Make the suits light enough, agile enough, and smart enough, and all fetters to the imagination will face away.

How far away is such a day? Perhaps a generation, to be conservative, not much more. Certainly, a risk-averse NASA will never allow such frivolities. We will see the rise of such activities with the appearance of orbital tourist resorts.

There is more to space than rockets and modules. The space suit has equal power to make or break the future. Present NASA suits are cumbersome and motion-restrictive and require hours pre-breathing and special atmospheres. Efforts to develop better suits -- and thruster packs -- have fallen victim to low-priorities and mis budgeting. It will be up to the space tourist economy to give birth to less restrictive and more comfortable and more agile suits. <MMM>

## MMM #150 – November 2001

[The following piece would seem to have nothing to do with designing a much more capable and more economic Space Transportation architecture. Rather it is about attitude, without which we won’t succeed in this stated goal!]

### **The Parable of “Stone Soup”**

By Peter Kokh

There are undoubtedly many versions of this story, as I have met others who knew of the parable and got it from very different sources. I heard it from an African missionary priest.

One day while, making a call on villagers that they had never visited before, a pair of missionaries was seized by warriors, their hands bound behind them. Meanwhile, other villagers were gathering kindling to put under a giant pot. Growing worried, one missionary asked what was going on. “Why we are getting ready to have you for dinner,” the chief said. “You look healthy! You will make good soup!”

Thinking quickly on his feet, the other missionary spoke out saying, "if it is good soup you want, we have a much better recipe!" The chief, his interest piqued, demanded that the missionaries tell him about this splendid recipe.

"Well first, you must free us so we can help you find just the right stones to put in the pot first. The right stones are the secret ingredient that makes our soup so good."

Their bonds loosened, the missionaries led a group of young warriors into the forest where they pointed out the stones that the warriors should pick up and put in the pot.

Now, they said to the women who were watching with much curiosity, "we need to add vegetables. Let's add all the various kinds of vegetables you have on hand." After that the missionaries supervised the adding of spices.

The soup, it turns out, was very good, and happily did not include themselves as a special ingredient.

### The morale of the story

Sometimes we have none of the ingredients needed for a project, **nothing, that is, except the idea itself.**

But if you leverage that idea wisely, and play your cards right, others will contribute the things you don't have and can't get.

Can we apply this lesson to space enthusiast efforts to get pet projects started and see them through to completion? Why we already have! Space enthusiasts had the idea of a Lunar Polar Orbiter that would look for lunar polar ice. And back at ISDC 1988, that's all we had. An idea and a few hundred dollars. But we called a conference in the spring of 1989 in Houston, and as a result of that, Al Binder was "hired," Lockheed picking up his salary, to design a probe, which we named Lunar Prospector. Now you know the rest of the story.

The Lunar Reclamation Society and the Moon Society are small organizations with big ideas but without the resources to make those ideas real. Not quite! Ideas can be powerful. But it does take some work to articulate them well enough to attract the attention of others who can contribute other needed resources. It takes leveraging connections, diligent networking, and not missing too many tricks. But if we did it once, we can do it again, and again, and again.

**The Stone Soup route to the Stone Moon! Never underestimate the power of an idea!**

## MMM #159 – October 2002

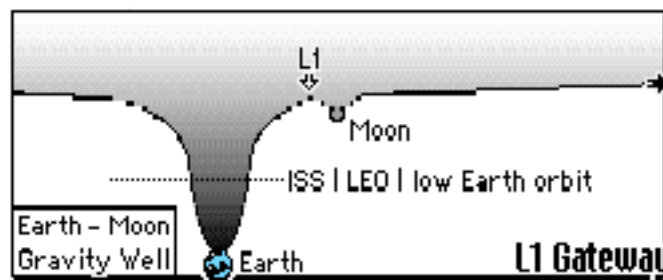

### Expanding the Manned Space Envelope

### The Earth-Moon L1 Gateway

[www.space.com/news/beyond\\_iss\\_020926-1.html](http://www.space.com/news/beyond_iss_020926-1.html)

NASA's New Plan for the Moon, Mars & Outward and

[http://utstaging.space.com/business/technology/moon\\_next\\_020923-2.htm](http://utstaging.space.com/business/technology/moon_next_020923-2.htm) (\*)

Article & Commentary below by Peter Kokh (\*)

"NASA is developing a progressive plan for placing humans back onto the Moon. NASA Exploration Team (NExT) members at the Johnson Space Center have scripted a breakthrough strategy ... [that]



makes use of existing launch capability and existing technology to establish a staging point at a so-called Earth–Moon Lagrangian Point, L1.

“Here’s why L1 is important: In each system of two heavy bodies (the Sun and Jupiter, or Earth and its Moon) there exist five theoretical points in space at which a third and small body, under the gravitational influence of the two large ones, will remain approximately at rest relative to them.

**“From the Earth–Moon L1 point [between the Earth and the Moon],  
a window to any spot on the Moon is reachable with minimal rocket energy.”**

Note: the distances given between L1 and the Moon and L2 and the Moon are calculated from the Moon’s center. For mean distance to the nearest point on the Moon’s surface, subtract 1,089 mi = 1,728 km.

### **A Plan in its Infancy**

NASA’s Exploration Team [NExT] has done little more than identify the need, and the location where that need can best be met. Any plan to build and erect another “Space Station” – this one at the Earth Moon L1 Lagrangian Point Gateway would have to be approved by Congress in order to become a budget item. There is probably no reason to begin planning implementation strategies, until NASA is ready to talk to Congress about the idea.

### **What it does and does not mean**

That the L1 point is ideal as a gateway for flights to anywhere on the Moon’s surface, NASA’s interest in this gateway does not mean that the agency has made a decision to return to the Moon, over, or before, sending humans to Mars.

The beauty of the L1 Gateway is that it is also an ideal spot for staging missions to Mars. In other words, the establishment of an Earth–Moon L1 Gateway would enable all competing scenarios for the expansion of the Manned Space Envelope beyond low Earth orbit.

### **Usefulness of a Lunar L1 Gateway Station**

#### **(a) Research & Logistics**

- testing the radiation environment in high Earth orbit (HEO) and techniques for maintaining a habitat environment safe for humans beyond the Van Allen belts – Apollo astronauts have been beyond that protection for no more than several days per mission.
- teleoperation via relay of SPA (South Pole–Aitken Basin) return sample mission (MMM #157 p. 4) and other surface probes
- teleoperation via relay of Farside radio telescope

#### **(b) Manned Lunar surface Operations support**

- teleoperating prospecting & mining equipment in surface locations remote from manned outpost
- Staging | rendezvous for maximized efficiency configuration for space to lunar surface ferries
- a cryogenics fuel depot to provide braking fuel for craft bound for the lunar surface at much less cost than bringing that fuel all the way from Earth’s surface (LUNOX: liquid oxygen produced from processed moon dust) | LH2)

#### **(c) Mars Mission support**

- ideal quarantine site for Mars Sample Returns
- assembling larger Mars–bound spacecraft in an environment free of orbital debris at a facility that needs much less station keeping fuel than in low Earth orbit with more frequent & wider launch windows to Mars
- refueling (topping off) Mars–bound missions with lunar liquid oxygen and possibly hydrogen brought up from the

Moon’s surface at a fraction of the fuel cost of getting them all the way “up the hill” from Earth

That such a gateway could enable and facilitate so many space mission/manned mission operations, makes it a win-win idea certain to gather much more widespread (if less enthusiastic) support than either a Moonbase or Marsbase proposal could garner. This very aspect of “positive indeterminacy” (my terms) makes it a safe proposal for Congress persons to get behind. It pushes our future without making premature choices, leaving those choices to sort themselves out on their own merits

The Space Frontier Foundation has already issued a supporting policy statement. Our recommendation is that the National Space Society and the Moon Society do the same.

## Our suggestions for go-withs and phase-ins

- L4/L5 relay sats – small Data Relay Satellites at the Earth–Moon L4 and L5 Lagrange points would facilitate dedicated relay covering the farside flanks of nearside, reaching 60° past the east and west limbs of the Moon.

They could be equipped with simple Dust Counters to qualify the “environment” of these possibly very dusty

“Sargasso Sea” regions. Weight allowances and commercial sponsors willing, they could include teleoperated Amateur Telescopes to train on this beyond the limb reasons for the first time.

- An Unmanned Help–Yourself Fuel Depot be established first: this would consist of a LUNOX tank farm to allow less expensive Earth–Moon and Moon–Earth flights. Attached station–keeping\* thrusters would tap this fuel supply to keep the fuel depot “at” L1 as this position is not as stable as the L4 and L5 areas.

\* [L4 and L5 can be described as “bowl–shaped gravity valleys” – any deviation from the center causes a drift back to the center. However L1 (and 2 and 3) are better described as “saddle valleys” with the saddle perpendicular to the Earth–Moon axis. Any movement to the side causes a drift back to the center, whereas any movement in the direction of the axis will keep gaining momentum and send the object on a collision course with Earth or the Moon as the case may be.]

- A Tool & Common Parts Crib could be added
- A Habitat Module could be added which would be for the use of personnel in transit and occupied only while a manned ship is docked at the station
- Crews could arrive at L1 a proper amount of time before the start of temporary assembly jobs, e.g. of larger ship consists headed out to Mars, returning to Earth when the job is done.
- In other words, this Gateway need not start out as another permanently occupied Space Station. This more modest, just in time staffing proposal would be far more likely to be approved by the keepers of the purse strings.

## Implications for a Free Enterprise venture to open the Moon to resource–using settlement:

- If the L1 Gateway is pursued in the form of a robotic facility open to use by all who pass that way, it can serve the cause of a commercial lunar overture just as easily as that of a NASA–led manned expedition to Mars.
- NASA has been bragging, a bit prematurely we think, about having commercialized the International Space Station. What NASA seems to understand by “commercial” is not the same as what most proponents of free enterprise access to space mean by it. But by careful and judicious writing of the enabling legislation, something with which it behooves all of us to be involved, we can end up with a “positive–neutral” facility genuinely helpful to all types of ventures. We need legislation that does not pick winners and losers, which does not exclusively suit the world view of a socialized space program.

NASA does have a role, valued by all and not in dispute, to play in opening the Moon, of course.

- First we need a number of follow up orbiter–lander missions whether designed by NASA or elsewhere but flown as NASA Discovery missions: South Pole Aitken basin sample return “ground truth” polar lander probes to quantify and qualify potential ice resources
- Oregon L5’s proposed Lunar Lavatube Locator mission
- Beyond that it will be largely a NASA task to set up optical, radio, and other astronomical observatories on the Moon. If NASA opens the door to space rather than keep posing as the door, the L1 Gateway could be, in Martha Stewart’s words, “a good thing.” <MMM>

## Online Reading:

**Strategic Considerations for a Cislunar Space Infrastructure** by Wendell Mendell

<http://ares.jsc.nasa.gov/HumanExplore/Exploration/EXLibrary/DOCS/EIC042.HTML>

[as a staging point for Mars missions, ISS] “has features which diminish usefulness and longevity, thereby limiting its ability to support long term piloted spaceflight. These include:

- “Lunar/Mars launch window constraints: Launching vehicles to the Moon and Mars from a LEO “ship–yard” is complicated by continuous changes in the alignment of the space station orbit relative to the desired trajectory [limiting] the number and duration of available launch opportunities.

- “Orbital debris: Artificial space debris is an increasingly significant threat to LEO facilities as space traffic increases. Space Station Alpha will carry rockets for collision avoidance and a substantial mass of shielding.
- “Atmospheric drag: LEO stations pass through the outermost reaches of Earth’s atmosphere, so suffer drag and eventually decay from orbit and burn up if not periodically reboosted.”

**The Lunar L1 Gateway**, Martin Lo/Shane Ross (Space 2001, Albuquerque)  
[http://www2.esm.vt.edu/~sdross/papers/lo\\_ross\\_2001\\_abs.html](http://www2.esm.vt.edu/~sdross/papers/lo_ross_2001_abs.html) [abstract]  
 “.. natural Interplanetary Superhighway System ..”

## Some Past L1 Station Proposals

The idea of a Gateway Station at Earth–Moon L1 = Lagrange Point 1, a semi–stable “gravitational divide” 84% of the way from the Earth to the Moon, is not new. To many space transportation system architects, it’s a natural concept. “the Earth–Moon L1 point is the physical entry point into the lunar environment.” – Badri A. Younes/GSFC

An L1 station would serve as end terminal for Earth–Moon ferries that remained in space all the time, never

touching a planetary surface. On our end, a space station in low Earth Orbit acts as a depot transfer station for people coming from/returning to Earth’s surface on a space shuttle of some kind. On the other end, an L1 station acts as a depot for people getting off of shuttles coming up from the Moon’s surface, or getting on those same shuttles for the trip down. In between is the domain of the ferries -- and someday, the liners.

This was the original Von Braun idea, but we could never have “won” the “race” to the Moon if we had stopped to build either or both depots. So NASA designed the Apollo command module as both the ferry and as the return Earth shuttle; and the Lunar Excursion Module as the 2–part low lunar orbit to lunar surface shuttle.

A consensus decision was made to put any further exploration of the Moon on hold until these transportation nodes were in place. In retrospect, that was a flawed decision. There is such a thing as “just–in–time” infrastructure. We don’t need an O’Hare field, much less a Kansai International – if all we are flying are Ford tri–motors. That’s AN interesting topic for another issue

Those of you who have seen the 1991 Made for– TV Disney/Zlatoff film Plymouth about a pioneer settlement on the Moon engaged in Helium–3 harvesting, will remember that the last wave of settlers took one ship out from Earth, then transferred to a lunar shuttle at the L1 depot some 38,000 miles Earthward from the Moon.

In the Kubrick/Clarke epic 2001 (1968) : a Space Odyssey, Dr. Heywood Floyd takes a shuttle up from Earth to a “real” spinning space station in Earth Orbit, then an Earth–Moon ferry, and finally arrives on the Moon aboard a large lunar shuttle.

**The whole point of having a pair of gateways is to gain economy from allowing Earth surface to orbit craft be specialized precisely for that task, Lunar surface to orbit craft be specialized for that run, and to use ferries designed to spend their entire lives in space to economically transferring people in between the two gateway depots.**

Yet, until the traffic warrants, the bottom line may favor shortcuts. We’ll get our L1 gateway depot in time, but why wait to get started? – PK

**MMM #160 – November 2002**

## Upper and Lower Moonbase

In last month’s issue, we explored NASA’s recent resurrection of an old idea, a manned space facility at the Earth–Moon L1 Lagrange point. This month we see how it could logically develop on a “just–in–time” schedule, and work to accelerate, rather than delay, the expansion of surface activities. That’s the way it would be done if business and industry is in charge.

# Constructing an L1 Gateway on a “Just-in-Time” Schedule

(the way Business & Industry would do it)

“If the Moon had a moon, what could we do with it?”

By Peter Kokh

## Asking the Right Questions

In this essay, we want to approach the idea of an L1 Gateway with a clean slate drawing board, putting out-of-sight, out-of-mind, the recent elaborate mega-proposal from NEXT, NASA's Exploration Team. Instead, we would like to answer two simple questions:

1. If the Moon had a moon, what could we do with it?
2. How could you phase in an L1 Gateway in a logical step-by-step “just-in-time” fashion while you are establishing and developing a first lunar outpost?

## If the Moon had a moon ...

To be fair, we should add “a moon always parked above,” for essentially, that is the great logistical asset of the L1 position. Anything parked in that gravitational “mountain pass” is always “overhead” from any outpost or vehicle on the surface on the Moon’s nearside. As opposed to any satellite or craft in a low lunar orbit which would be in access range only part of the time, this parking lot in the nearside sky suggests some interesting possibilities:

- an ideal place for relaying messages and teleoperation instructions between one spot on the Moon’s nearside and any other
- an ideal spot to cache supplies, equipment, tools, etc. for the use of travelers between Earth and Moon
- the only ideal place to put a solar power array for beaming energy to anywhere on nearside during the long nightspan period

These service opportunities could be provided one at a time, and ramped up on a “just-in-time” basis as the costs involved become justified in relation to the amount of use and savings they provide. In other words, we suspect that the L1 gateway could, and should, be grown, and phased in, just as the lunar outpost is grown, and phased in, on the surface. There is no reason under the sun to “complete” either all at once before operations at either can begin.

Armed with that conviction, we would urge outright rejection of the NASA-NEXT plan even if the money were there. It is simple common sense that the only logical way to develop something complex is in an orderly step-by-step coevolution with whatever other developments are codependent upon it. But in point of fact, NASA would, if it could, develop L1 completely as a manned gateway before deciding to establish lunar surface operations (as opposed to using the gateway mainly as a Mars jump off point.)

This NASA approach may look like political cowardice, but it is a tack NASA is forced to take given the decades long lack of direction from Congress and the Administration. However this approach would only repeat the costly mistake of developing the International Space Station without reference to its logical depot functions.

Both a lunar outpost and an L1 gateway facility are best left to industry and enterprise. Only they have the mindset to do either logically. “Just-in-time” development would lead to a symbiotic pair of installations. “Symbiotic growth” would accelerate, rather than delay the pace at which we could advance from deployment of the first permanent habit structure on the Moon’s surface to a first permanently inhabited local resource using frontier town.

Many space activists are impatient. Some would advance the date of the first manned mission to Mars even if it chanced that any opening of the Mars frontier to settlement might be delayed decades as a result. Others would skip L1 Gateway development to make an earlier start on a first moonbase even if it meant that the evolution of that first humble outpost into a settlement were retarded. It is a basic cosmic law that impatience always backfires. So let’s make the case for doing things right. Impatience is an itch that we cannot afford to scratch!

## Upper and Lower Moonbase

It is our thesis that we should be thinking in terms of a pair of moonbases, one on the surface, one parked above the surface in space, and that:

- a. We should develop both symbiotically in co-dependence
- b. Doing so will advance rather than retard the pace at which surface operations expand at the original settlement site
- c. Doing so will advance rather than retard the pace at which surface operations spread to other sites on the Moon's nearside

**“Early,” “Transitional,” “Fully Operational” phases**

Lets attempt a first trail balloon sketch of the phases by which L1 Gateway “Upper Moonbase Services” to a Surface Moonbase could be realized. This crude “reference mission plan” will be revised as others have input.

**Early Phase:** virtual (teleoperated) staffing – this is a list of services that could be provided without any on hand staff, with all control from the ground, preferably from the surface Moonbase rather than from an Earthside mission control, as the time delay would be much shorter, 0.4 seconds vs. 2,6 seconds., significantly closer to “real time.”

- Communications Relay connecting Nearside outposts & vehicles in transit, and allowing Moonbase personnel to teleoperate robotic rovers thousands of miles away.
- Search and Rescue capabilities anywhere on nearside (faster, with superior resolution, than from Earth)\
- Tie in with outrigger relays at L4 and L5 to reach 2/3rds of farside as well Fuel Depot – drone tanker ferries teleoperable from the surface would attach LOX tanks to a rack, and other lunar-produced fuels and oxidizers as they become available. This would create a “gas station” to refuel craft bound for the Moon – or for Mars.
- Solar Power Array for gateway operations (1) and for nightspan operations of the surface base and other surface installations. This array could be built and expanded in modular fashion as demand dictates. Thus the L1 gateway becomes a part of the solution of the “Nightspan Problem.” The costs and versatility of such a power system will have to stand comparison with those of nuclear and non-nuclear surface options for providing or storing power for nightspan operations.

Transitional Phase: crews on duty when needed – If we add a habitat module complex that can accommodate visiting crews, we can do even more:

- Warehousing contingency resupply items for much more timely response to emergency needs anywhere on the nearside surface from this nearby cache accessible 24/7/365. A fresh Moonbound crew from Earth could pick up supplies even if the request came after their departure from Earth.
- A self-help Tool Crib | garage | docking port – where craft plying between Earth and Moon (and Mars) can be serviced, repaired, or assembled by the crews passing through – no permanent staff necessary
- A Mars Sample Return Quarantine Lab could be docked with the facility and staffed when samples arrive. Here isolation and quarantine from Earth’s biosphere are assured and the chances of accidental contamination in either direction enormously minimized.\
- Fully Operational Phase: permanently staffed – As the scope of surface operations expands and the number of people on the surface grows, permanent staffing of the L1 Gateway would be in order. A permanent staff could:
  - Maintain the complex and oversee its continual growth.
  - Handle a steady stream of Earth-bound, Moonbound, and Mars-bound traffic, providing a more complete list of services to spacecraft, crews, passengers, and immigrants. This would eventually include hotel operations..While passengers bound for the Moon would probably be on location only for brief visits, those en route to Mars might be there for some time awaiting a window to open, or awaiting craft assembly.
  - Include a Medical Facility for first treatment of crews and passengers transferring at the gateway. This could include a Zero-G infirmary for patients from the Moon for cases where such treatment is prescribed.
  - A variable G facility in which persons who have lived on the Moon for a long period can recondition themselves gradually for a visit or permanent return to Earth.
  - Maintain a growing Solar Power beaming operation that supplies not only nightspan base power to permanent surface operations, but full time power to surface vehicles in transit with dedicated slaved beams with power loads on demand from the engaged vehicles controlled by feedback

loops. This would greatly assist remote and mobile mining operations as well as freight and passenger transportation between surface destinations dayspan and nightspan alike.

### **One step at a time – Easy does it!**

You can see from the above, that there is no need to plunge into the full scale development of an L1 gateway facility. Following the sequence of the Artemis Project mission plan, the first payload to be dropped off at L1 would come after the first surface crew deployed the initial permanent habitat structure and auxiliary equipment but in time for the delivery of the first rover and the arrival of the first overnighing crew.

The first L1 Gateway payload would consist of a relay satellite with station-keeping ability and a host expansion rack for the addition of add-on equipment. Would a first modular power generation and beaming array come next? This is a whole new area of logistics not previously considered by Moon mission planners. We invite all interested parties to get involved in the brainstorming. What comes when? What size and capacity when? How do we best synchronize development of this “Upper Moonbase” with the surface “Lower Moonbase?” <MMM>

**MMM #164 – April 2004**

## **The Interlunar Cycling Station: Traveling First Class**

By Dave Dietzler <[pioneer137@yahoo.com](mailto:pioneer137@yahoo.com)>

There's a right way and a wrong way to do everything. Traveling to the Moon in small ships made from external tanks with spartan accommodations will be okay with adventurous travelers in the early decades, but someday we are going to need something better. Those E.T. ships are rocket fuel guzzlers. Nuclear electric propulsion with ion or VASIMR drives looks like the answer.

Well, that's the wrong way. The Moon has plenty of magnesium for electric drives; however, the problem is the low thrust of electric drives. It will take weeks, perhaps months to spiral out of LEO and reach the L1 point or lunar orbit. The crew and passengers will die due to Van Allen Belt (VAB) radiation unless the ship is shielded to an absurd degree. A bigger power plant will get us more thrust out of those electric drives and get through the VABs in a few days, but we will still need heavy shielding and our travelers will endure some minor radiation exposure. This will be very bad for the crew that must endure repeated passages through the belts and accumulated cellular damage.

The best power plant would be a vapor core reactor with MHD that produces two, even three, kilowatts per kilogram of total system mass—that includes radiators, pumps, etc. Research into this type of system has been done at the Innovative Nuclear Space Power Institute of the University of Florida [1]. Even so, the power plant must be enormous to produce the energies needed to push a ship carrying about 500 passengers through the VABs in just a few days. When you add up the shield mass and the power plant mass there's only enough left for rather spartan accommodations in the ship like sleeping closets instead of cabins, no "artificial gravity," shared bathroom facilities, less volume per passenger than was on the MIR and general cramped, less than luxurious conditions. The ship mass becomes so great that the use of efficient NEP doesn't reduce propellant demands very much. NEP is ideal for ships bound for Mars that accelerate slowly out of GEO or the L1 port because they don't need so much shielding—just a solar flare shelter, and they can take weeks to escape from Earth orbit and leave the drive on continuously for weeks to reach high speeds and shorten travel time to Mars. For interlunar luxury liners we need something entirely different -- the cycling station.

The cycling station will be very large. It will be propelled onto its orbit once and never again need but a tiny bit of propellant to make course corrections. “There ain't no such thing as a free lunch,” but the cycling station comes close. Taxis will be necessary to reach the cyclor. Since these vessels will be small and only capable of carrying passengers for a few hours at most, they won't guzzle much rocket fuel and oxidizer. A cycling station that swings around Earth at an altitude of 500 km. (310 mi.) and ride out to 469,526 km. (292,000 mi.) will have a period of 13.66 days or half the Moon's sidereal period of 27.32 days.

Twice a month it will swing around Earth at 10.689 kps. (23,900 mph) and at apogee roughly 470,000 km. (292,000 mi.) out it will be creeping along at only 0.1545 kps (345 mph). Once a month,

on every other orbit, it will enter the vicinity of the Moon. When it rounds the Earth, taxis in LEO will fire their motors and catch up with the cycler. The taxi will dock with the cycler and passengers will transfer to the cycler. At or near apogee they will return to the taxi and ride over to the L2 spaceport station. From there they will descend to the surface of the Moon in rocket powered shuttles. Several cyclers could allow Moon travel at various times of the month. The ride will take about a week.

### **Aboard the Cycling Station**

The station will rotate to provide "artificial gravity" and have roomy cabins with private bathrooms rather than just bunks or sleeping cubicles and unpleasant vacuum toilets. Passengers will sit down to normal meals eaten with a knife and fork. Cooks will enjoy their art with the benefit of weight. Space sickness will be averted.

Medical emergencies will be easier to handle with patients who don't float off the operating table. The station will hurtle through the VABs in just hours. Nobody will endure even the slightest increased risk of cancer. There will be no complex nuclear power plant that requires costly uranium and extensive maintenance. Environmentalists will not go on the warpath and tie the company up in law suits lasting years because of nuclear reactors in LEO. In a country where juries award \$45 million settlements to people who spill coffee in their laps, this is a real problem.

The cycling stations could be made of [Space Shuttle] External Tanks connected to form a rotating ring. There will be dining rooms, game rooms with ping-pong and pool tables, coffee rooms, bars with beer on tap, dance floors, maybe even a small swimming pool and garden. There will also be weightless rooms in the hub and a small observatory.

Cabins will have king sized Murphy beds, flat panel TVs, and other features common to terrestrial or lunar hotels including a bath with running water. A system of antennas throughout the station linked by coaxial cable that connects with a comsat linking radio transceiver will allow cell phone usage aboard the cycler.

Propulsion of the cycler into its orbit will be done with efficient solar electric drives over the course of several months, and at most, a year. Some small aluminum and LUNOX (lunar oxygen) rockets will also be used. After

the cycler is situated in its orbit, it will use the solar electric drives and Aluminum/LUNOX rockets to make minor orbital adjustments. Lunar flyby will affect the cycler's trajectory in ways that I cannot predict, thus course corrections will be needed from time to time.

The taxis will consist of single E.T.s fitted with rocket motors, LSS, etc. Basically, they will be interlunar ships like those described in the January, 2003, Moon Miner's Review #32, refitted with couches for about 400 people. There's a lot of room in one of those E.T.s. It may be possible to cram more people in there, but I tend to be conservative. A taxi will use about 600 tons of Al/LUNOX to rendezvous with the cycler and transfer to L2. Another 600 tons will be needed to leave L2 and retrorocket into LEO on the return flight. Retro-rocketing into LEO seems safer than aerobraking. Three tons of fuel and oxidizer will be needed for each of the 400 passengers. Since it will take about fifty cents worth of electricity to launch a pound from the Moon with mass drivers, it will only cost each passenger \$3,000 for propellant alone -- much less than the cost of propellant for a trip aboard one of those old spartan 50 passenger ships that are now taxis.

When everything is added up the round trip might cost an individual as little as \$100,000! Call it wishful thinking! If the cycling station consists of two rings of 12 E.T.s each and four E.T.s in the hub, for a total of 28 tanks, there will be about 56,000 cubic meters of volume or 140 cubic meters per person with 400 people aboard. The Skylab had 100 cubic meters per occupant. A nuclear submarine has about 70 cubic meters per person and the

Salyut station had 50 cubic meters per person [2]. Cycling stations will truly be space luxury liners.

FOOTNOTES:

[1] <http://www.inspi.ufl.edu/index.html> and [www.highway2space.com/ast/presentations/7g\\_knigh.pdf](http://www.highway2space.com/ast/presentations/7g_knigh.pdf)

[2] Marshall Savage. The Millennial Project. Little, Brown & Co. 1994.

NOTE: I used the Quick Orbits program from delta-utec to determine orbital velocities, etc. Also, 28 ETs would amass 925 metric tons, so a guesstimate for the station's mass would be about 2000 tons at most. That's lighter than the

NEP liner I tried to design (in MMM # ) with its massive radiation shield and power plant. The taxis could use much less than 1200 tons of propellant also with just a small increase in Isp from 250 sec. to 280 sec., but I try to estimate conservatively. <DD>

**P.S.: For a previous design study of what an Earth–Moon Cruise Hotel Ship might look like, see the "The Frontier Builder: An Earth–Moon Hotel Cruise Ship: a Definition & Design Exercise" © 1992 Doug Armstrong & Peter Kokh. The authors concentrate on ship design and architecture after discussing the activities that should be accommodated. They also discuss ways to keep the ticket price down. I chose to concentrate on the propulsion question, the one aspect they did not address. Well illustrated. See: [http://www.moonsociety.org/publications/mmm\\_papers/transitel.htm](http://www.moonsociety.org/publications/mmm_papers/transitel.htm)**

## MMM #174 – April 2004

### Experimental Lunar Rockets

By Dave Dietzler < [Dietz37@msn.com](mailto:Dietz37@msn.com) >

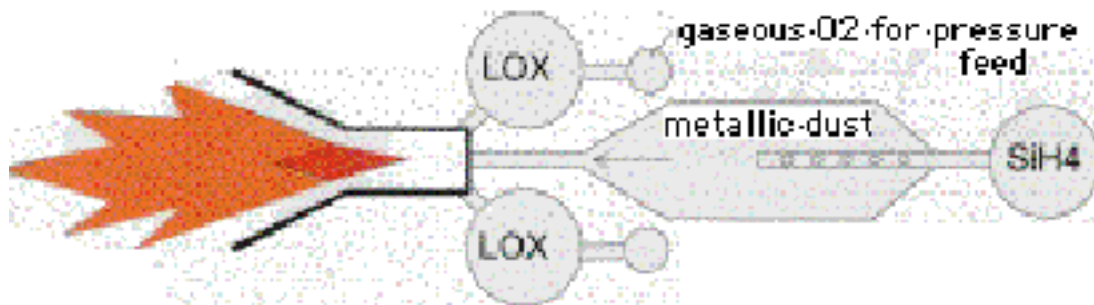

Silane carrier gas/powdered metal base fuel rocket motor

#### Burning Lunar Aluminum in Liquid Lunar Oxygen

Several ways to burn lunar aluminum and LOX in rocket motors have been proposed. Some have suggested a roll of sheet aluminum or foil, wire mesh or a hexagonal array of aluminum bars in a hybrid motor. Aluminum dust and LOX have been mixed up to form a monopropellant.

My suggestions have been aluminum beads fused together at the edges or aluminum dust in a binder of metallic calcium in a hybrid motor. The calcium makes the aluminum more "friable" – able to remain in powder form.

Real situation testing is needed

All these ideas need extensive testing not only here on Earth but in the vacuum and weightlessness of space and in the low gravity of the Moon. Fire burns differently in microgravity. Solid fuels that might slog out of the rocket nozzle on Earth might stay in place in low lunar gravity or in space. LOX / aluminum mixtures might separate in a gravitational field but remain suspended in "zero-G."

Rocket motors using aluminum dust suspended in crystalized sulfur, molten sulfur and LOX or molten sulfur and aluminum dust slurry are also worth investigating. A number of small experimental rockets should be tested at the ISS and at the future lunar outpost. Model rocket enthusiasts should get a thrill out of that!

#### Hydrogen assisted aluminum / oxygen combinations

Also of interest are rockets that burn a slurry of liquid hydrogen and aluminum and/or magnesium powder. A slurry of silane [SiH<sub>4</sub>, a liquid quasi analog of Methane CH<sub>4</sub>, silane could serve as a "hydrogen-extender"] and aluminum and/or magnesium is also of great interest.

We need hydrogen to make silane and there isn't much of it in regolith. From 100 million tons of regolith, enough to get one ton of <sup>3</sup>He, we could get 4,000 tons of hydrogen. That's enough to make 32,000 tons of silane which would be burned with 64,000 tons of LOX. That's plenty for an early mining base, but it won't be enough for tourism! If we can make a slurry of SiH<sub>4</sub>, Al and Mg that is perhaps 25% to 30% silane by mass, we could greatly extend our hydrogen resources. If you compare two rock-



ets, one using LH<sub>2</sub>+LOX at 450 seconds and the other using SiH<sub>4</sub>+LOX at 340 seconds you will find that the silane rocket uses as little as half as much hydrogen.

If there really is six billion tons of water at the lunar poles we don't have to worry about a hydrogen shortage for a long time, but it would be wise to extend our hydrogen resources by making silane anyway. If we could make a slurry of silane and metal based fuels we could slash hydrogen demands even more. Silane has a much higher boiling point than LH<sub>2</sub> (-112 C. versus -253 C.) and is much denser ( 0.7 g/cc versus 0.07 g/cc), so it will be easier to handle, liquefy and store. Rockets running SiH<sub>4</sub> will have smaller fuel tanks than rockets on LH<sub>2</sub> and this will allow a better mass ratio.

I wonder about the reliability of Al+LUNOX burning hybrid motors. The aluminum fuel could literally fall apart and that would be catastrophic. If we use alloys of aluminum and magnesium which have much lower melting points than either of the two metals they are composed of, things will be entirely different. Since there is so much magnesium in regolith we want to burn it if we can.

#### **Iron, silicon ,and other fuel options**

Iron is plentiful and available in powdered form. But it has a very low heat of combustion and the exhaust product is very heavy so iron may not make a good rocket fuel for space vehicles. But powdered iron has been proposed by several investigators as a rocket fuel for lunar "hoppers" shuttling in ballistic hops from one location on the Moon to another. Iron oxide powder would be the rocket exhaust from such an engine.

Silicon is abundant and it burns with as much heat as aluminum but is harder to ignite and keep burning. Alloys of magnesium, aluminum and silicon must be investigated. So we have a variety of substances to experiment with.

The silane plus LUNOX rocket should be reliable even in a gravitational field. The SiH<sub>4</sub>, Al, Mg slurry might sludge out in the Moon's gravity. It might do the same thing under acceleration in space. Maybe an in-tank agitation system could prevent that. Perhaps a system using metallic powders flushed into the motor by gaseous silane rather than a slurry fuel would be superior.

Time for down and dirty homework

The rocket jocks have a lot of research ahead to keep them busy in the future. Perhaps some of these fuel combinations could be safely investigated as part of science projects, certainly in College and University Engineering Departments. Now if only we could come up with an X-Prize type incentive for the most promising demonstration! Availability of all lunar fuels minimizing hydrogen would advance the attainment of economic breakeven . < DD >

#### **Back Reading from MMM issues past:**

"Bootstrap Rockets" MMM #6, June 1987 <http://www.asi.org/adb/06/09/03/02/004/bootstrap.html>

## MMM #176 - June 2004

### Musing about Space Elevators: Drawbacks & Advantages



By Dave Dietzler <[Dietz37@msn.com](mailto:Dietz37@msn.com)>

I've been reading up about space elevators. I'll concede that they are possible, but only if we can mass produce C60 carbon nanofiber cables and do it cheap, and only if we have rockets big enough to send the reel of cable plus its electric motors and solar panels up to GEO.

It will take a lot of horsepower to haul things up 22,400 miles so we will need big solar panels array. As David Heck and I agreed way back in December, I believe, space elevators will be slow. If you climb the cable at 1,000 miles per hour, which will take a lot of energy (just consider fuel gulping jets that travel at this speed), it will take almost a day to reach orbit!! A rocket or jet/rocket spaceplane can get you to LEO in ten minutes. This is an important consideration.

And what if the cable snaps? Can you parachute down? You can parachute back or glide back in rocket propelled vehicles if there is an engine failure. The bright side is that space elevators won't explode.

Another drawback is that a space elevator only touches one place on Earth. A rocket can take off from anywhere on the globe. And space elevators can only take you to GEO or fling you off the counterweighted end into space. Rockets can ascend to any orbit and any altitude and any inclination to Earth's equator. So space elevators are not a free lunch and rockets will be with us for a long time.

I do see one great use for near term space elevators – cargo. Humans can fly up in rockets. Cargo can be hauled up slowly to GEO. So what if cargo takes its time or the cable snaps? Cargo is what costs. Humans aren't that heavy. Ten humans with luggage only weigh a metric ton if we estimate 100 kg. (220 pounds) per person and luggage. With an early space elevator consisting merely of a cable and a reel we can send thousands of tons of cargo to GEO. From there it will either be flung off the end of the counter balancing cable at about 44,000 miles up or use ion drives to go to lunar orbit or a Lagrange point station or even Mars. In this way, we can have our cakes and eat them too. We can fly humans via our VTOLs and HOTOLs to LEO space hotels and haul cargo up by cable to save a fortune. Whether it will be economical to send loads of rocket fuel up to GEO and then send it down to LEO via ion drives to fuel up taxis in LEO that they fly to higher orbits, cycling stations or escape velocity I do not know. Making sure all this does not crash into the cable will be tricky.

In Arthur C. Clarke's **Fountains of Paradise** a 44,000 mile high tower was built. If we just have a big station at GEO and lower a ribbon of C60 nanofiber to Earth's surface and extend a counterbalancing ribbon another 22,000 miles this should be much more practical than a solid tower, and this is something we will be less likely to crash into as it can be reeled up and out of the way with advanced warning!! More to think about. <DD>

Editor's own musing: Hey Dave, what if we have a cable passenger car that rides up the elevator à la maglev? Once the car cleared the atmosphere, it should be able to build up some real speed without heat from air drag or friction from contact with the cable.

But what about power demands? If the power were generated in space by a solar power satellite network, the amount of power needed might not be a problem.

Personally, while I believe a space elevator could work, I am a "doubting Thomas" about finding a way to build it. It is going to be one very tricky engineering proposition, and I'll have returned to stardust long before it becomes more than science-fantasy.

### **Launchtracks, an alternative to Elevators**

As to cargo, let's not forget the other long-talked-about option: launch tracks up the side of equatorial mountain massifs. In essence, a launch track is a grid-powered "first stage" that remains on the ground. We highlighted a set of candidate mountains in MMM # 99 Oct. '96; p 4. "Mountains Made for Launchtracks" – which identified four special merit peaks:

- **Mt. Cayambe**, Ecuador, 19,160 ft., 0°, 40 m. NE of Quito
- **Mt. Kenya**, Kenya, 17,040 ft., 0°, 100 mi. NNE of Nairobi
- **Mt. Cameroon**, Cameroon 4+°N, 13,353 ft., 60 miles from the Nigerian border, 10 mi N of the port of Buea
- **Mt. Kinabalu**, Sabah, Malaysia, 13,455 ft., 6+°N. Near NE tip of Borneo. About 40 miles ENE of the South China Sea port of Kota Kinabalu, and 80 miles WNW of the Sulu Sea port of Sandakan

All of these are on or near enough to the equator and have reasonable transportation access. The first two are checked for being virtually smack dab on the equator. As such both are candidate mountains for an Earthside terminus of a space elevator, one handy for the Americas, the other handier for Europe, Africa and western Asia. The last, while 6+ ° off the equator, would be handier to Pacific Rim customers.

Launchtracks have the significant advantage of being deployable from Earth's surface, and involving nothing more exotic than Maglev transportation. Reserved for cargo canisters only, to be delivered to a specified holding area, an orbital "cargo yard," they could be engineered for massive G-forces and seem significantly more near term. Let's pursue both options, pushing the possibilities as far as they will go, making no premature choices. Balloon-launching is another nearer-term option, but one that has met with limited trial success and promises less down the road. <PK>.



THE OUTPOST TRAP

## Technologies Needed to Break Free

By Peter Kokh

Despite the best of current announced intentions, it is politically and economically predictable that NASA's lunar outpost (even if is "internationalized" by taking on "partners" in a contract) will be stripped of any and all features seen as "frills" or "extras." Consider how the planned 7-man International Space Station was summarily slashed without partner consultation in the stroke of a presidential pen to a 3-person one: 2.5 persons needed for regular maintenance and a half-person is available for scientific research. It can and will happen again, unless ...

It becomes our cause, the accepted challenge of those of us who owe it to our own dreams, to do every-thing in our power to get the outpost built, outfitted, and supplied on a more rigorous and stasis-resistant path. The/a lunar outpost must be designed with expansion in mind, with a suite of easy expansion points, expressing an architectural language that is expansion-friendly. No all-in-one "tuna can stack", please!

To this end, we must reexamine every aspect and angle of setting up a lunar outpost.

### I. Transportation System Architectures: Designing cannibalizable items for strategic reuse in Earth-Moon Transportation Systems.

**NOTE 1:** The author is not a rocket scientist, engineer or architect. The examples given below may not all be feasible, but we hope that those that are not, will suggest other possibilities that are worth exploring.

**NOTE 2:** We do not expect NASA to embrace any revolutionary space transportation system architectural turnabout. But it is something that commercial space transportation providers might do well to study.

**NOTE 3:** Those in the business may be quick to insist that these ideas are all impractical. So be it. They are not part of the solution. We are looking not for those who say "it can't be done," but for those who say "we'll find a way to do it anyway!" If it were not for the "Young Turks" in various fields, we would all still be swinging from the trees. We must find the hidden, unsuspected pathways!

Way back in MMM #4, April 1987, we pointed out that Marshall McLuhan's dictum that "the media is the message," might be transposed to "the rocket is the payload." Of course, you can only push this so far. But this daring architectural philosophy offers the best way to escape the imagined, unnecessarily self-imposed tyranny of the mass fraction rule. "Of the total weight, 91 % should be propellants; 3 % should be tanks, engines, fins, etc.; and 6 %t can be the payload."

<http://www.allstar.fiu.edu/AERO/rocket5.htm>

This article is reprinted at the start of this issue. We are not talking about exotic fuels or better rocket engines, but ways to include the 3% "tanks, engines, fins, etc." into the payload.

In the case of the Shuttle, the mass of the vehicle is much greater than the mass of the payload, so we do not come close to the ideal. At the time (the April 1987 article), I offered this simple example. In the shuttle space transportation system, the payload that gets to stay in orbit is a needlessly small portion of launch vehicle mass.



Adopting philosophy “the rocket is the payload” we could, if we so dared, deliver much more to orbit.

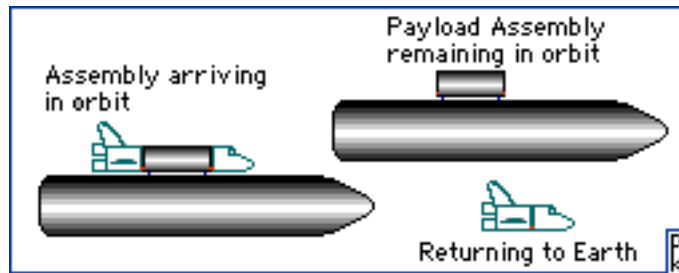

In the suggested alternative, the orbiter has a fore and aft section: Crew Cabin and Engine pod with much smaller wing/tail assembly. There is no payload bay. A much larger payload, with a light-weight faring if needed, takes its place. The External Tank is also placed in orbit as part of the payload. A stubby shuttle is all that returns to Earth. Savings include not just the payload bay section but the much lighter smaller wings and tail. The article referred above to is reprinted in MMM Classic #1, p 10, a freely accessible pdf file at:

[http://www.moonsociety.org/publications/mmm\\_classics/mmmc1\\_Jul2004.pdf](http://www.moonsociety.org/publications/mmm_classics/mmmc1_Jul2004.pdf)

Again, don't waste time writing MMM with all the reasons this couldn't be done. Instead, consider yourself chal-lenged to figure out how we could do this anyway.

This is only one suggestion of how we can “cheat” the mass-fraction “rule.” The shuttle system will not figure in the establishment of a lunar outpost. So it is not these details, but the spirit behind them that we are trying to get across. Attitude, attitude, attitude!

### Terracing the way back to the Moon

It seems unlikely that the Lunar frontier will be opened with vehicles that depart Earth's surface, make the entire trip out to the Moon, and land on the Moon's surface directly. So what we have to examine is all the various parts:

- Earth surface to LEO (low Earth orbit) transports
- LEO to Earth Moon L1 or Low Lunar Orbit ferries
- Lunar orbit to lunar surface landers

At each phase, if the vehicle addresses the design challenges, material and/or useful assemblies and sub-assemblies can be deposited at the next. Whether it be all in one ride, or by a succession of waves, more payload gets delivered to the Moon's surface, and/or more robust way stations are constructed in LEO and LLO (low Lunar orbit) or at the L1 Lagrange point. No opportunity is missed. See “The Earth-Moon L1 Gateway” MMM #159, OCT 2002. You can download this issue freely at:

[http://www.moonsociety.org/publications/mmm\\_classics/mmmc16\\_July2007.pdf](http://www.moonsociety.org/publications/mmm_classics/mmmc16_July2007.pdf)

We would be remiss if we did not point out that one of the most brilliant components of the **Artemis Project™** Reference Mission architecture involved just such a mass-fraction cheating device: reduction of the portion of the landing craft that “returns” to the open-vacuum “space motorcycle” I think it can be shown that most objections to this design as vulnerable to micro-meteorite impact are baseless. Micromete-orites strike the Moon, and spacesuited astronauts!, on the surface, with velocities much higher than the velocity such a craft would need to reach lunar rendezvous orbit. It was the incorporation of this feature that allowed the Artemis Project™ ferry to deliver the relatively massive triple unit SpaceHab-based outpost core to the surface.

Whether the Artemis Project™ Reference Mission will fly as designed is not our topic and irrelevant. The point is that it demonstrates, at least in this instance, the kind of breakthrough paradigm-scuttling innovation that alone will get us to the Moon “to stay.”

### Stowaway Imports: smuggling more to the Moon

Another article we wrote that suggests ways to “smuggle” more useful material and items to the Moon is “Stowaway Imports” in MMM #65, May 1993. This article is republished in MMM Classics #7, freely downloaded at

[http://www.moonsociety.org/publications/mmm\\_classics/mmmc7\\_Jan2006.pdf](http://www.moonsociety.org/publications/mmm_classics/mmmc7_Jan2006.pdf)

The idea here, is that it is inevitable that there will be structural, outfitting, or packaging items aboard craft landing on the Moon that are not needed for the return to the vehicle’s base, be it in LLO, LEO, or Earth itself. The cost of getting these items to the Moon is prepaid as part of the cost of getting the payload consist to the Moon, whether or not they remain on the Moon or not. So if we leave them there, these items are a bonus.

Packaging containers, stuffing, dividers, etc. can be made of items not yet possible to duplicate on the Moon: some Moon–exotic element such as copper, or an alloy, some reformable plastic, biodegradable materials useful as fertilizers, nutritional supplements, whatever. Everything not absolutely needed for the ride back is game for scavenging. On crewed vehicles this can consist of everything from tableware to bedding, to appliances and even cabin partitions.

Some items can be thoughtfully predesigned for second use on the Moon as is. Others will be melted down or reformed for the useful material they contain. It’s all free, or at least at less cost than replacing them for the next outbound trip to the Moon. Only the “squeal” need return!

Designing moon–bound craft to be cannibalized in this fashion will require resourcefulness, and exploration of a lot of options, some more promising and less difficult than others. Stowaway imports are a way to supplement what personnel on the Moon will be able to produce or fabricate for themselves, thus leading to swifter development of a more diversified lunar startup economy.

Cargo craft landing on the Moon might be designed for one way use only. Fuel tanks will be prize imports, landing engines may be reusable for surface hoppers. The idea is to build these craft cheaply and in numbers, much in the mold of WW II “Liberty Ships.” If some crash or go astray, the loss will not be critical.

In our Lunar Hostel’s paper (ISDC 1991 San Antonio, TX

- [http://www.moonsociety.org/publications/mmm\\_papers/hostels\\_paper1.htm](http://www.moonsociety.org/publications/mmm_papers/hostels_paper1.htm)

we introduced the “frog” and the “toad” – Moon ferry under–slung crew cabins that could be winched down to the surface, lower its wheeled chassis, and taxi to the outpost: amphibious space/surface craft. The “frog” would return. The “toad” would be designed to spend the rest of its service life on the Moon as a surface transport “coach.”

### **Modular Transportation**

One of the more outstandingly successful innovations of modern transportation is the pod. Cargo in uniformly sized and shaped pods is transported on trucks, flatbed railway cars, and ocean going cargo ships.

The space transportation industry, especially the commercial sector, would do well to develop standardized pods, not waiting upon NASA clues which may never come, simply because the need does not arise in the very limited NASA lunar outpost mission plan. There may be more than one pod design, however, depending on the nature of the cargo. Liquids and aggregate materials (a load of wheat, for the sake of an example) may require container constraints, for shipment through the vacuum of space, that large assemblies do not.

The pod agreed upon would have significant repercussion for modular systems shipped to the Moon: modular power plants, modular water recycling systems; modular regolith processing systems; modular food processing systems; modular hospital cores; the list of possibilities is endless. No one size is ideal for all applications. However, we suggest that the current modular factory system serve as a model and size guideline, as it has proved remarkable successful. See MMM #174 April, 2004 “Modular Container Factories for the Moon.” You can download this issue freely at:

[http://www.moonsociety.org/publications/mmm\\_classics/mmmc18\\_Jan2008.pdf](http://www.moonsociety.org/publications/mmm_classics/mmmc18_Jan2008.pdf)

Such a pod could also deliver inflatable modules to the Moon, which could then be outfitted on location, with cannibalized components and/or items manufactured by startup lunar industries. The result would be quicker build–out of the original outpost structure.

### **Transportation Systems Architecture Upshot**

If we intend to expand the outpost into a real industrial settlement on an “inflationary fast–track” – the only way it can be done economically – the Earth–Moon transportation system must be so–

designed from the gitgo, down to the last seemingly insignificant detail. A missed opportunity could spell the difference between success and failure. Our purpose in giving the examples above is less to fix attention to our examples than to get across the spirit. Spacecraft architecture, systems architecture, industrial design for reusability as is or with minimum processing effort, choice of materials, etc. And all vehicles at every stage should be designed this way.

Again, these lessons will be lost on NASA as its objectives are strictly limited: to deploy a moon-base in order to prepare for manned exploration of Mars. “.” But commercial providers are likely to look for more extensive use of their products, for other more open-ended markets. It is with them that all hope lies. Those that adopt the above philosophy as a cornerstone of their business plans are more likely to survive and thrive long after NASA’s government-limited goals are met.

MMM #209 – October 2007

## THINKING OUTSIDE THE MASS FRACTION BOX: 1

NASA’s Lunar Architecture Design Goals  
are Good, but not quite what we need to Maximize our Lunar Presence Investment

By Peter Kokh

Moon Society Advisor and Videographer Chip Proser has asked me to define the steps we need to take to realize a human presence on the Moon to support a full buildout of an Earth-Moon Economy. Actually, we have talked about most of the elements and steps needed in various articles in MMM through the years.

### Thinking within the “Mass Fraction” Box

But it is a very worthwhile endeavor to do the exercise afresh, and with deliberation. We’ll make a start with this article, laying out basic concepts to “really maximize” the payload delivered to the Moon. This means throwing out the window of the slavishly worshiped law of “mass fraction.” According to Wikipedia,

“In aerospace engineering, the **mass fraction** is a measure of a vehicle's performance, determined as the portion of the vehicle's mass which does not reach the destination. ... In rockets for a given target orbit, a rocket's mass fraction is the portion of the rocket's pre-launch mass (fully fueled) that does not reach orbit. ... typically around 0.8 to 0.9 [80–90% of the takeoff mass does not reach orbit]”

The figure is even more discouraging when we are considering the typical mass fraction deliverable to the lunar surface.

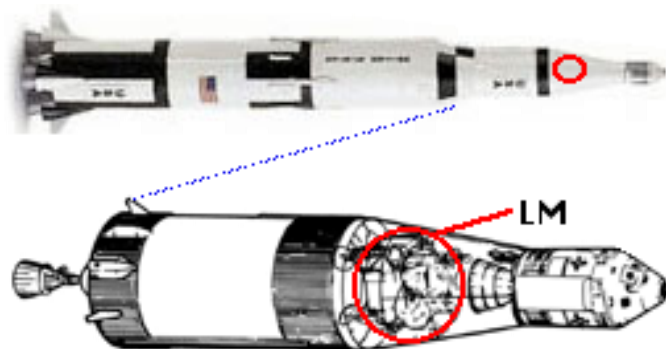

The goal, adopted by NASA, to design the landing craft in such a way as to maximize delivered payload, is excellent. According to the Connally Study:

- minimize ascent module mass
- minimize descent module mass
- maximize landed “payload” mass
- simplify interfaces

- move functions across interfaces when it makes sense

Thus, by use of a minimal ascent vehicle, NASA can land a much more spacious crew cabin. But this is still a sample of thinking within the Mass Fraction Box.

### Thinking outside the “Mass Fraction” Box, Part 1

When you think of it, the payload “landed to remain on the Moon” in the Apollo missions consisted only of the descent stage, and assorted equipment left behind. Not much! NASA’s new “space-motorcycle”-inspired plan will allow leaving the spacious crew cabin behind. That’s a big step, but still within the “Mass Fraction Box.”

Our first article on “Thinking outside the “Mass Fraction Box” was “**Essays in ‘M’: Marshall McLuhan: “Medium is the Message”** in MMM #6, June 1987. This is republished in MMM Classic #1 – download from:

[www.moonsociety.org/publications/mmm\\_classics/](http://www.moonsociety.org/publications/mmm_classics/)

In this article, we pointed out that the most common flaw in thinking within the “mass fraction box” was to assume without question that no part of the vehicle itself could be reassigned as “payload.” We illustrate the possibilities by offering an alternate configuration for the Space Shuttle Orbiter. I urge you to download that volume cited above, if only to get this point across.

Here we are talking about delivery to the lunar surface. In that context, our quest to cheat the “mass fraction” rules drives us to make sure **that everything that we have paid precious fuel to land on the Moon, and which will not depart on the ascent vehicle, is something that has more than temporary usefulness: that includes every part of the landing platform mass:**

- fuel tanks & descent engine & ● vernier rockets
- cargo hold & ● unloading equipment
- leg struts & ● foot pads, ● etc.

There are several approaches and types of solutions for this design challenge:

- The item can be reused as is. for example, the bulk of the descent platform, minus engines and fuel tanks, might be reused as a platform for a telescope
- The item’s design could be tweaked to enable it to serve some different application, whether similar or quite different, e.g., landing struts could be assembled in line to use as an antenna mast, or alternatively to serve as part of a space frame for a canopy shed
- Perhaps part of the descent stage equipment could be designed as a mobile chassis for the crew cabin, either to taxi the cabin to its installation site, or to turn the cabin into a pressurized lunar surface bus.
- The item could be forged of a material invaluable on the Moon, such as lead, copper, brass, or stainless steel; some components, for example shipping stuffs, could be made of reusable plastics, or compressed biodegradables rich in nutrients scarce in the regolith

You get the idea. See “Stowaway Imports,” in MMM # 65, May 1993, republished in MMM Classics #7, downloadable from web address above.

We would be delighted to see the NASA Moon Lander Office adopt these design goals also. This is not a new philosophy. Poor people are known to use all parts of a slaughtered pig “except the squeal!” NASA should and must adopt a “we are poor” posture, in the sense that the agency will never get all the money it might want and must learn to make do with what it gets. And to do that successfully, means not to cut this and that, that’s a petulant knee jerk reaction, but to exercise maximum resourcefulness. Use everything twice!

Note that our subtitle at left reads: “Thinking outside the “Mass Fraction” Box, **Part 1**” We hinted in our reference to the article from MMM #6, that the launch vehicle itself, and every stage of it, can be redesigned to add more to what lands on the Moon and **contributes to the buildup of the lunar outpost/settlement.** We’ll leave you with that thought until next time. **MMM>**

MMM #210 – November 2007

THINKING OUTSIDE  
THE MASS FRACTION BOX: 2

# Improving on NASA's Lunar Architecture Design Goals

By Peter Kokh

In the first installment last month, Part 1, we talked about making maximum use of everything landed on the Moon. That way everything we land on the Moon becomes payload delivered, not just the crew and cargo. Let's carry the argument further.

## The Translunar Injection Stage as a Deliverable

Any part of the Earth Orbit <> Lunar Orbit ferry vehicle that delivers the landing craft to low lunar orbit for its descent to the Moon's surface, which is not needed for the return to Earth orbit can be delivered the rest of the way to the lunar surface at little extra cost. What things this may consist of depends on the vehicle's design. Expended fuel tanks (unless they are refueled with lunar liquid oxygen) and farings are two obvious suggestions. Of course, this implies that these items can be replaced in LEO for the next trip out to the Moon.

In Apollo, the Saturn 3rd stage that brought the LEM and Apollo Command Module was effectively tossed overboard, left to crash on the Moon. (area in dotted box)

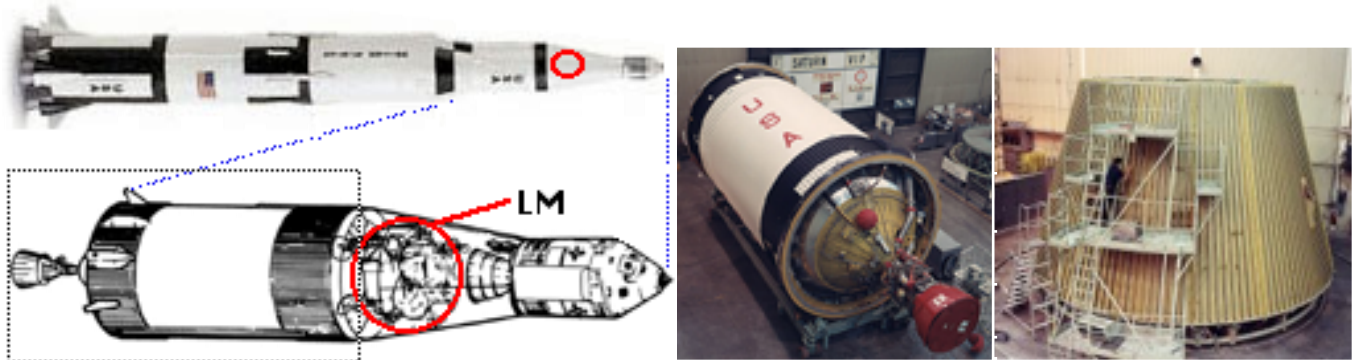

Saturn S-IVB left

S-IVB Adapter Skirt right

[http://en.wikipedia.org/wiki/Saturn\\_V#S-IVB\\_third\\_stage](http://en.wikipedia.org/wiki/Saturn_V#S-IVB_third_stage)

The S-IVB: 58' 7" [17.85m] tall/long; 21' 8" [6.6m] wide, such a volume landed could provide ample storage, or, set on its side, a spacious 2-floor habitat module. The adaptor skirt covered the S-IVB engine and mated the S-IVB to the Saturn 2nd stage. This could be saved also.

Yes, to deliver this stage the rest of the way to a soft landing on the Moon requires more fuel, but at least the oxygen required could be brought up from the lunar surface. Delivered, this adds large fuel tanks which could be put to welcome use in the moonbase, plus an engine, cannibalizable wiring and other components. Remember, we already paid the freight to get it almost all the way!

Those with shortsighted vision would not want to bother, but if you are a prospective lunar pioneer, not to take advantage of such a golden opportunity would be unforgivable, and as lunar frontier history may someday judge, forever listed as an act of unthinking treason against the future Lunar Republic.

We are not suggesting that the Lunar Module ride to the surface atop this 3rd stage, though if we decided to do that, the weight savings involved in not needing to equip the Lunar module with its own separate descent stage engines and tanks, might go a good ways toward paying for the extra fuel.

The equivalent of the Apollo Command Module needed to return crew to Earth orbit or to Earth directly, could be dropped off en route, breaking into lunar orbit, while the 3rd stage with lunar module and minimized

ascent stage continued directly to the lunar surface. It's a different lunar architecture but the potential payoff in "total payload delivered" is too great not to pursue. As we work out the design and tradeoff particulars, a show-stopper problem may emerge, but with the right attitude, we can bet that a doable workaround will be found.

In the scenario above, even the farings that protected the lunar lander on its trip up through Earth's atmosphere, could make the trip all the way. They would surely be useful for one thing or another.

**A Proper Guiding "Philosophy" is essential**



We must always keep in mind that maximum total payload mass delivered is the Holy Grail. That implies, of course, that we have predesigned every “hitchhiking” component to be able to serve new uses and functions on the Moon, or have made that component of a material that we cannot yet produce on the Moon, or may never be able to produce, such as copper, brass, zinc, lead, and reshapable thermoplastics, to name a few.

What about parts for which we can foresee no reuse or reapplication potential? We can think of two approaches right off the bat. Make them of materials needed on the Moon. Store them up until someone does have use for them. At the very least, they can be used in frontier sculptures, symbolizing the effort it took to establish the frontier! Art is one very important way we begin to accept our new surroundings as “home.”

Face it, we will not have bottomless financial reserves, we will need to be spartan. Why not borrow the operating principal used by the poor who need to use all of everything that comes their way, in this example, a slaughtered pig -- “use everything except the squeal.” To put it in more common terms, we need to maximize and ramp up our “resourcefulness.”

### **This is not “Apollo II”**

We need to remember that in the Apollo program, the idea was not to establish a permanent base, but to conduct a series of science “picnics” at scattered surface sites. In that light, minimizing landed mass on the Moon was the proper design goal. Now, as we pick one site and try to build it up to the point where it becomes a truly functional complex serving a wide variety of operations on a long term basis, everything changes. We will want to deliver as much, not as little, as possible.

By including as second class payload, not just crew, cargo, and initial cabin, but the entire landing craft and perhaps the entire assembly that left Earth orbit bound for the Moon, we demolish the Old “mass fraction limits” on deliverable payload. And we demolish those limits at relatively little extra expense. The payoff of adopting this design philosophy is that a given stage of moonbase buildout can be reached in fewer trips from Earth, or conversely, with the same number of trips from Earth, we can reach a much larger, more complex and elaborate lunar outpost buildout.

This is important for an operation that needs to maintain public and political support to continue. The more we achieve with the lowest cost, the faster our presence on the Moon grows first to a fully functional science and exploration outpost, then towards one involving a growing number of civilians involved in industrial operations aimed at tackling Earth’s energy and environmental problems, the more surely it will survive changes in political administrations, and congressional whims.

### **A parallel with the Opening Act of the Universe**

The only safe lunar outpost expansion philosophy is an “inflationary” one, growing and evolving very fast, not very slow. Until we reach a stage where our presence on the Moon can survive periods of interrupted support from Earth, everything is tentative, subject to a change in the winds that could mean a second retreat from Luna.

Such a swift buildout approach will, when all is counted up, be significantly less costly than a go slow, pay as you go approach. Time is the most costly expense of all. We should know this from the Shuttle program. Initial cost per launch figures were based on sixty launches per year, one every six days. Now we are lucky to do four or five. But the expense of the standing army of people needed for turnaround, as well as of management, never goes down in proportion to mission rate.

Further, with each delay, inflationary pressures come into place. To get our money’s worth we not only have to reuse everything sent toward the Moon on the Moon, but we need to buildout our lunar facilities and operations with all due speed.

### **The “Medium is the Message”**

We noted last month that extending Marshal McLuhan’s dictum that the medium is the message to rocket transportation and delivery architectures, the rocket itself can be part of the payload, if properly designed, in all its parts, for useful applications at the delivery site.

Meanwhile, the original second stage, which delivers the moon-bound stack to Earth orbit, should itself be predesigned so that all its components can serve some useful function in Earth orbit, building up the transportation hub with refueling, assembly, and maintenance operations functions. We’ve already paid the freight to deliver its fuel-expended dry mass to LEO. If we do not leave it there and find some way to use it to ramp up orbital operations, we are just tossing money away. Here too, we can treat the Mass Fraction limits.

It begins to look as if the Mass fraction rule was a product of neanderthal thinking. We got to where we are by taking advantage of every opportunity, not by mindlessly throwing opportunities away, because in our narrow horse-blinded professions we can't see the possibilities!  
Next Month, Part 3 – Bootstrapping through LEO and LLO with early lunar products.  
<MMM>

MMM #211 – December 2007

### THINKING OUTSIDE THE MASS FRACTION BOX: 3

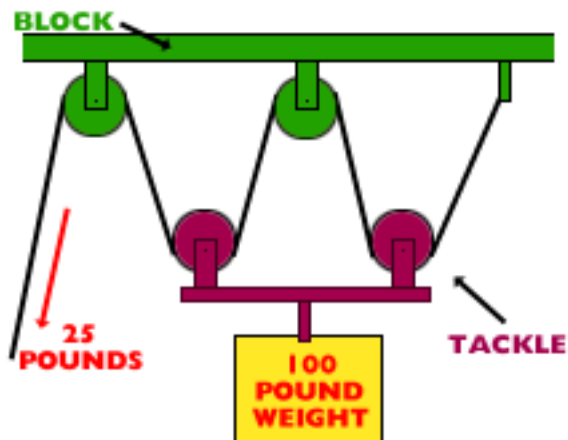

#### The Block & Tackle Pulley as an Analogy of the Power of Leveraging Concurrent Space Developments to deliver much more to the Moon

By Peter Kokh

“ in Earth orbit you are halfway to anywhere”  
Heinlein

– Robert A.

#### The “effective” cost of goods delivered to the lunar surface depends on the amount, or lack of infrastructure along the way.

Archimedes invention of the pulley more than 2200 years ago is one of the most important mechanical contributions to early civilization. By realizing a predictable mechanical advantage, the “energy cost” of moving an object from one plane, say Earth’s surface, to another, say the Moon’s surface is significantly reduced. The block and Tackle pulley multiplies the advantage.

What does this have to do with space transportation in general, and with the cost of delivery of goods from Earth to the Moon in particular? We certainly are not talking about setting up a physical block and tackle system in space! Rather we want to apply the analogy above in a way that illuminates the best way for us to proceed.

In short, transporting things to the Moon without any intervening infrastructure, i.e. not cashing in any infrastructure discounts or advantages, is going to remain very expensive. The “Moon Direct” plan, if we can call it that, is the “horse blinder” choice. “We are directed to put an outpost on the Moon, not to establish infrastructure along the route.” What looks like dedication will someday reveal itself to be an outright waste of resources and opportunities. Future Lunans may even view it as criminal.

In previous parts of this article, we have noted that anything taken to orbit that might be useful in setting up shop on the Moon, but left to fiery destruction as its orbit decays, could be taken to the Moon at much less expense from LEO than from Earth’s surface – if Heinlein is right, for about half the cost. And that includes a lot of material, whether usable in its current form or not. The deliberate “wasting” of the External Tank is but the most obvious and long standing forfeit of opportunity. We fully understand all the disadvantages and obstacles to reusing the ET. But they are insignificant in comparison to what could have been gained by committing to the modest expense of parking them in a higher very long duration orbit until the opportunity to use them in LEO or take them to the Moon arose. As a Society, we have become addicted to favoring short-term advantages over long-term goals, and such a

habit, if we don't fight the addiction, could have us following the Romans into oblivion. Again, I understand the excuses. But excuses are just what they are.

The same holds true of anything else delivered to LEO and GEO, which when no longer useful there, could be delivered to the Moon at "half the cost." LEO and GEO are pulleys in any future fully developed lunar transportation system. So is the Earth-Moon L1 Lagrange point and other lunar orbits. Anything delivered that far that could be used, reused, restructured, or cannibalized on the Moon will be far cheaper to deliver than an equivalent item all the way from Earth.

### **The Lunar side of the Block & Tackle**

I remember Gordon Woodcock's paper which sought to prove that lunar oxygen used to refuel Moon-bound cargo ships, could only reduce the cost of shipping to the Moon, but not make it profitable. Duh! What's wrong with reducing costs? Lunar oxygen, which is abundant beyond exhaustion, can be shipped to L1 and to LEO with every returning vehicle, to partially refuel each next Moon-bound craft. LOX is thus another pulley in the system. As to LH2, which is not in large supply on the Moon, we oppose shipping that off-Moon as fuel, or even for using on the Moon as fuel, except for fuel cells in which hydrogen can be recovered. Any shipment of hydrogen off the Moon limits the size to which lunar settlements and biospheres can grow. In that perspective, such shipment and usage becomes treasonable against the Lunan Frontier.

### **Lunar Exports**

Many people point out that the Moon has nothing of value "on Earth" except perhaps Helium-3, and maybe platinum (I am very dubious of this latter idea.) What these people are failing to understand is that the logical export partner of the Moon, is not Earth, but LEO. Anything that can be made on the Moon to fit service needs in LEO can be shipped to LEO at a 20:1 fuel cost advantage over shipment of equivalent goods up from Earth's surface. Of course, that statement does not factor in the need to amortize the costs of developing lunar industries needed to export such items. That does not change the argument, however.

Items made of concrete, cast basalt, glass, alloys of steel, aluminum, magnesium, and titanium are candidates. Yes, there will be some specialty materials that lunar industries won't soon be able to match. But in designing LEO installations – space stations, laboratories, factories, tourist facilities, whatever, if the design team tweaks the design to use lunar products, the cost savings will be considerable. Even dehydrated food, over 50% lunar oxygen by weight, can be shipped more cheaply to LEO than from Earth! The point is, that all these export products will help defray the cost of shipping things in LEO the rest of the way to the Moon. Another Pulley!

### **Not to forget GEO**

GEO -- Geostationary Earth Orbit -- is long overdue for wholesale restructuring of the way the limited and invaluable slots along this orbit are assigned and utilized. With large platforms supplying power and station keeping, serviced by robotic tugs, many communications and other GEO satellites can share the same orbital slot, taken to the platform by the tug, and "plugged in." GEO is almost saturated in our present "hunter-gatherer" level of allotting space. How will products from the Moon help?

We already understand that lunar materials can bring down the cost of solar power satellites and relays in GEO by substantial proportions. [See last month's MMM proposal for a World Wide Orbital Grid.] These same materials can help build new and larger platforms for communications and other uses. And the tugs needed will be of use as well in LEO in maximizing reuse and salvage of items in orbit, including gathering them for transshipment to the Moon. GEO platforms, power systems and tugs -- another Pulley"

### **"Mechanical" Cost Advantages**

Any estimate of what it will cost to open the Lunar Frontier, that neglects the opportunities to ship to the Moon anything shipped to LEO, GEO, or other points in between and no longer needed at those points, or which neglects to credit exports from the Moon to LEO, GEO, or other points between will necessarily be fantastically outlandish.

At the same time, we are not saying that opening the Lunar Frontier will quite pay for itself in the near future. That said, we are confident it will do so much more quickly than most authorities now estimate. Those less optimistic predictions are a natural, given the human tendency to be too optimistic in predicting the near-term future and far too pessimistic in predicting the long-term future.

I was asked recently to outline “The Ten Steps Needed to Create an Earth–Moon Economy.” I dislike pre–set outlines. Whether it is five steps or fifty is uncertain. But this set of articles on “Thinking outside the Mass–Fraction Box” are my first installment towards an answer to that request. In other words, we are not going to succeed in setting up an Earth–Moon economy without paying attention to “the pulley points” along the way.

**LEO & GEO can only be fully developed using the significant cost advantage of Lunar materials and exports.**

**The Moon cannot be fully developed without access to materials and items shipped to LEO which when they are of no further use there, are then transshipped to the Moon.**

### **The first Step: a refueling station in LEO**

At the 2007 International Space Development Conference in Dallas over the Memorial Day Weekend, Dallas Bienhoff of Boeing gave a convincing presentation that simply by refueling Moon–bound craft in LEO, we could deliver 60% more goods for the money. Please view the three video segments produced by the Moon Society in which Bienhoff explains his thesis.

<http://link.brightcove.com/services/link/bcpid537086541/bclid537026504/bctid1171893807>

<http://link.brightcove.com/services/link/bcpid537086541/bclid537026504/bctid1173355232>

<http://link.brightcove.com/services/link/bcpid537086541/bclid537026504/bctid1171893809>

Bienhoff is correct in saying that NASA has an obligation to identify the least expensive way back to the Moon. However, that constraint imposed by Congress, is shortsighted, in words we all know, “pennywise and pound foolish.” The current Spartan approach can only be defended if setting up a lunar outpost is a goal in its own, without considering further use of that outpost, or further lunar developments.

Many years ago, I wrote in an In Focus editorial which I can’t locate at the moment, that the space enthusiast community has all too often attempted to sell the ladder of our dream one rung at a time. When we do that, the rung in question gets designed as a be–all and end–all in itself, not as a rung leading to the next rung, not as part of the ladder. Thus we have only ourselves to blame for the Space Station becoming a black hole for funding, leading nowhere. In the selling of the Station, it became not a depot to outer space as conceived of by Wernher von Braun, but a downward looking Earth–research laboratory, the pride of “yo–yo space.” We were afraid that if we talked about our real dream, no one would listen. The result of this space enthusiast consensus strategy of the early eighties is 20–some years since of going nowhere.

If we promote the NASA permanent, but not permanently occupied, science outpost as a goal in itself, that’s what it will become. Because we can’t allow ourselves as a nation to look further down the road, we will continue to make stupid shortsighted decisions which will only bring further delays to opening the Moon.

Anything that is worth doing is worth doing right. We have to rethink the NASA moonbase as a rung in a ladder, that means flushing LAT–2 down the LATrine. It’s a quite brilliant design intended to lead to nowhere.

### **Ten Steps to an Earth–Moon Economy?**

It includes building up a block–&–tackle–reminiscent set of cost savings enhancers in LEO, GEO, L1, and on the Moon itself. And it includes dumping LAT–2 constraints. NASA has rightfully canceled further biological life support system research as not of use for its current concept of the lunar outpost. Can there be any more eloquent clue that the agency is off track, way off on a tangent?

NASA itself admits the potential for using lunar resources, but has chosen for this Congressional assignment to constrict its vision to what is pertinent for the mission so defined. In its dedication, NASA has unwittingly chosen to become part of the problem. Yet the agency has enormous expertise and problem solving resources. It needs a change in direction that unleashes those talents. Perhaps the next administration will see to that. In the Apollo program, NASA was at its prime. Under present leadership, the agency is playing a caricature role, expertly. But this is the price we pay for a space program that continues to be a political football.

We, those of us in the bleachers, disparaged by NASA and the government alike, have to be vigilant for ways to make an end run around what is happening. The LEO and GEO and even Lunar export

options we have mentioned will be the work of private enterprise. That's our point of entry. Optimism has to be earned. <MMM>

## MMM #231 – December 2009

### AUGUSTINE COMMISSION RESULTS IN A NUTSHELL

John K. Strickland [jkstrick@io.com](mailto:jkstrick@io.com) November 2009

With the obvious proviso that the US government should **not** be building launch vehicles itself, for the next decade at least, the government, for good or ill, will have a large influence on any exploration or activity outside LEO.

The Augustine commission has given us some real direct benefits with its discussions and conclusions, such as stating in plain English the following points, of which I consider these to be the 20 most important ones: (Paraphrased points – all are from items appearing in the original Commission release on September 8, 2009). Here is a link to the summary report for reference:

[http://www.nasa.gov/offices/hsf/related\\_documents/summary\\_report.html](http://www.nasa.gov/offices/hsf/related_documents/summary_report.html)

- (1) Human spaceflight program planning should **begin with choices about Goals** before picking Destinations. (Here at last is Official Acknowledgement of the importance of first stating fundamental goals.) !!!!
- (2) There is a strong consensus in the US that the next manned spaceflight **goal** should be to go **beyond LEO**.
- (3) The intent or ultimate **goal** of the human program should be **expansion into the solar system**.
- (4) The best human **exploration goal** (with an extended human presence on the surface) is Mars, for a variety of reasons. (NOTE: This does not address the Moon as a **space** development goal or location)
- (5) Mars is the **ultimate long range destination** for human activities in the solar system, but it is **not** the best initial one.
- (6) A **transportation architecture** should be created which is “**flexible**” and can support **multiple objectives**.
- (7) (Human) Exploration will benefit from the availability of a **heavy lift booster**. (70 tons to LEO or more).
- (8) Switching to a **single launcher** development program from a 2–launcher program is more economical and could speed development.
- (9) Crew Transport to LEO should be turned over to the **Commercial Sector**.
- (10) A **new competition** to create this crew transport service should be initiated.
- (11) **Launch Service Guarantee Contracts** should be considered by the US Government to stimulate investment in and development of advanced launchers and to reduce ground to LEO costs.
- (12) **Commercial Transport of propellants to LEO** is important (and the Committee members showed strong interest in **Propellant Depots** as key to future human space operations – you need them for commercial propellant delivery.)
- (13) The Human spaceflight program should align with **national objectives**. (This could be an opening for **Space Solar Power** if clean energy is a national objective).
- (14) NASA should **resume** its critical role in long–range and critical areas of **technology development**.
- (15) **International Partners** should be engaged and integrated into the critical path components for future programs (This includes transport vehicles).
- (16) NASA's Administration needs the **authority to manage its own budget** and funding once it has been authorized.
- (17) The arbitrary **deadline** of late 2010 for ending the Shuttle program **should be relaxed** in the name of safety.

- (18)The planned Human exploration program is **not feasible** with the current budget. (An “Emperor is Naked” notice)
- (19)NASA will probably not have an Ares launcher ready **within 7 years**. (Another “Emperor is Naked” notice).
- (20)The Space Station should **not be de-orbited** just after it is finished. Such a move would be **illogical and wasteful**; and keeping it until at least 2020 will allow continuing scientific work and further international cooperation in space. (Still Another “Emperor is Naked” notice).

### The "Flexible Path" or Third Option

The "Flexible Path" or Third Option the Commission created can be both an obstacle and a benefit. If the option results in the creation of specialized, expendable spacecraft to explore asteroids, we will get some good science results (and good practice for long duration missions) from a few human expeditions to asteroids, and that is all.

**If, on the other hand**, it results in the creation of a set of flexible, re-usable spacecraft and a rational, integrated space transport system using private launchers to reach LEO, we will be ready to go to either the Moon, Mars, or asteroids. Let us hope it leads to the latter option.

### FLEXIBLE PATH: GOOD OR BAD

A discussion about NEO missions under the Augustine Commission’s “flexible path” option led to these conclusions.

<http://www.telegraph.co.uk/science/space/6425811/Asteroids-should-be-next-small-step-for-man-in-space-panel-tells-President-Barack-Obama.html>

In reference to flexible path missions to near earth asteroids, we should remember that: The vast majority of asteroids are basically made of very primitive rocks (ordinary chondrites), neither pure nickel-iron metal mix nor water-rich carbonaceous chondrite. (There are, however, significant amounts of the nickel-iron in the ordinary chondrites, but it would have to be separated from all of the rocky material).

Low Relative velocity Near Earth Objects tend to have very long intervals before they return to the vicinity of Earth again, since the orbits of NEO’s are often similar in period to the Earth. Thus any mineral extraction from a specific object is a process that would have to occur on the scale of decades.

- Objects which have more elliptical or highly inclined orbits and which may be synchronized with the Earth by accident, will have much higher flyby velocities, making rendezvous and return harder.
- Before you create a mining industry to exploit asteroid resources, you need a reason for that industry to exist. (What are you going to use the asteroidal materials for?)
- No one has yet created a spacecraft that uses artificial gravity, so there would be no gravity on any asteroid mission until we develop such spacecraft.
- ‘**Asteroids only**’ missions could become a near-term dead end, even though, long-term, they represent a vital source of bulk materials and minerals for a spacefaring civilization.
- We have to deal with the economics of space as it exists now, not in 30 years. Thus we need generalized infrastructure (and transport) development first, missions second. **JKS**

MMM #232 – February 2010

## An L1 Space Station: Gateway to the Moon

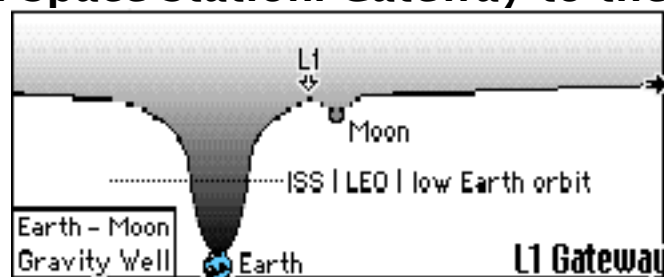

## Introduction

A space station at the Earth–Moon L1 point could greatly facilitate the build up of a manned lunar base. Humans could travel to the L1 station with chemically propelled rockets that dash through the Van Allen Belts to minimize radiation exposure time and descend to the lunar surface in chemically fueled Moon Shuttles. They could land anywhere on the nearside within hours to a day. Propellant for the Moon Shuttles would be delivered to L1 economically with electrically propelled robotic tankers that spiral slowly from LEO to L1. Cargos for the lunar base could be sent to L1 with electrically driven robotic freighters and then landed on the Moon with chemically propelled rocket landers. The best form of electric propulsion might be solar powered VASIMR with argon propellant.

The L1 station would allow humans to inspect, refurbish and even repair spacecraft for descent to the Moon or return to Earth. Back-up Moon Shuttles could be docked at the L1 station just in case Moon Shuttles on the lunar surface malfunction so that teams on the Moon don't find themselves stranded. This would improve safety and mission success rates. A small crew could remain on the station to monitor and if necessary repair tracking and communication equipment vital to the safety of explorers on the Moon. They could also maintain space telescopes on the station.

In the early days of lunar base buildup, crews on the L1 station could teleoperate robots on the lunar surface with only a fraction of a second delay time. Since there is a three second delay when teleoperating robots from Earth, robots must move slowly and can only do crude tasks. From L1, finer telerobotic tasks could be done necessary for readying a base for human inhabitation without incurring the cost of landing humans.

Although L1 is outside of the Earth's magnetic field, workers there would only endure radiation exposures similar to those expected for travelers to Mars and this will be tolerable if a solar flare shelter is included on the station.

## Manned Transportation

Since it takes less delta V to reach L1 than to retro rocket into LLO with a fully fueled lunar descent/ascent vehicle and then rocket back to Earth, Apollo style, a much smaller Earth launch rocket is needed. Instead of the Ares V monster rocket being developed at taxpayer expense, I suggest using a SpaceX Falcon 9 Heavy with a new cryogenic upper stage. This rocket could put 65,280 lbs. in LEO. Rocket engines burning LH2 and LOX could have a specific impulse of 460 seconds and an exhaust velocity of 4.5 km/sec. This is found by multiplying the specific impulse by 0.0098. Then we use the rocket equation,  $e^{(dV/c)}$ , to find the mass ratio. The mass ratio is the mass of the rocket and payload loaded with propellant divided by the mass of the payload and rocket empty after burning all propellant. The term  $e$  is the natural log, 2.718. This number is raised to the power of the quotient of the delta velocity,  $dV$ , that is the change in the rocket's velocity, divided by  $c$ , the exhaust velocity. Since the  $dV$  to L1 is about 3.15 km/s, we can use the rocket equation to determine:

- $e^{(3.15/4.5)} = 2.01375$   $65,280/2.01375 = 32,417$
- $65,280 - 32,417 = 32,863$  propellant mass
- tankage and motors 15% of 32,863 = 4929 lbs.
- $32,417 - 4929 = 27,488$  lbs or 13.7 English tons for the crewed module. This would include about a ton of propellant for maneuvering into and out of L1

A 13.7 ton spacecraft is very respectable. The Apollo Command module amassed 12,800 lbs, the Soyuz 14,350 lbs. and the Orion CM 19,000 lbs. The crewed module to L1 does not need a large service module with rockets capable of braking into LLO and accelerating to lunar escape velocity.

Landers, or Moon Shuttles, would be sent to L1 with electric drives and fueled at L1. I envision reusable single staged vehicles powered by LH2 and LOX. To prevent problems with cryopropellant boil off during lunar surface missions, reliquefaction devices tended by robots would be landed ahead of time.

## Robotic Transportation

Electric propulsion will definitely lower the cost of cargo transport to the Moon because it uses far less propellant and allows much more cargo from LEO to reach the Moon, so the price per pound is less. However, electric propulsion is slow so we must use space storable propellants like MMH (mono-methyl-hydrazine) and NTO (nitrogen tetroxide) for lunar landers. Non-toxic and inexpensive kerosene

and nitrous oxide are also possibilities. These propellants are not as powerful as LH2 and LOX so they will land less cargo.

What if we shipped space storable water to low lunar orbit and cracked it to hydrogen and oxygen at a LLO station, liquefied them and pumped them into empty landers with cargos on board arriving from LEO via electrically propelled vehicles? We could land larger cargos. The only problem is that a station in LLO is not going to stay in orbit because of the Moon's "lumpy" gravitational field caused by mascons. What if we shipped water to a L1 station and converted it to LH2 and LOX there?

MMH and NTO 316 sec. Isp or 3.097 km/s exhaust V. Since the delta velocity from LLO to the lunar surface is about 1.6 km/sec. we find:

- $e^{(1.6/3.097)} = 1.67$
- LH2 and LOX 460 sec. Isp or 4.5 km/s.

Since the dV from L1 to the lunar surface is about 2.4 km/s. we find:

- $e^{(2.4/4.5)} = 1.7$

So even though the delta V from L1 to the lunar surface is higher, LH2 and LOX have so much higher performance than MMH and NTO that the mass ratio therefore payload is about the same. In addition, less electric drive propellant would be needed to reach L1 because the dV to L1 is less than to LLO and just as important, less time would be required, and time is money. So there is an advantage to sending cargo to the Moon via an L1 way station.

Moreover, landers designed to run on LH2 and LOX could eventually be fueled on the Moon with propellants derived from lunar ices, if we can get them.

#### **R&D Projects to LEO**

- Falcon 9 Heavy, 65,280 pounds payload

#### **R&D Projects to o L1**

- Solar electric drive systems for propelling a medium sized space station with inflatable habitat modules and fuel storage tanks assembled in LEO, or even a renovated ISS?
- Propellant tankers using SEP (Solar Electric Propulsion) to deliver water to L1
- In space water storage, electrolysis, cryogenic liquefaction and propellant storage and transfer systems
- A cryogenic upper stage using LH2 and LOX for propulsion of a crewed module capable of re-entry at near Vesc that amasses about 27,000 lbs. to L1
- Reusable SEP cargo vehicle for moving landers and other payloads from LEO to L1

#### **To the Lunar Surface**

- Reusable single staged manned landers that use LH2 and LOX.
- Initial propellant for first descent sent to L1 with SEP as H2O that is processed to LH2 and LOX at the L1 station.

These vehicles will load up with enough LH2 and LOX to descend to the lunar surface and return to L1. Cooling equipment to keep the cryogenic propellants cold during a prolonged stay on the Moon will be landed ahead of time. Using hydrogen mined on the Moon to fuel these vehicles is undesirable because lunar hydrogen resources are so scarce. Since oxygen is abundant in regolith it would be possible to land these vehicles with only enough LH2 for return ascent to L1 and tank up on LOX on the lunar surface. Eventually, other fuels like aluminum will be produced on the Moon.

- One-way LH2 and LOX fueled cargo landers that will be "cannibalized" on the Moon

#### **Conclusion**

An L1 space station and Falcon 9 Heavy. rockets in addition to more new hardware like VASIMR drives would make for a cheaper, more reliable system for the Industrialization and settlement of the Moon. The Apollo system might have been the quickest way to defeat the Russians during the Space Race, but it is not the most efficient way to reach the Moon and the present Return to the Moon project is misguided. Instead of a taxpayer funded Ares V monster rocket that is too large for any commercial or defense payloads, a system based on privately financed Falcon rockets and an L1 way station should be developed. Electric drive systems and a reusable tug for transporting unmanned cargos from LEO to L1 where the tug docks with the L1 station and leaves its cargo module then returns to LEO to pick up another cargo module containing machines or water are also essential parts of this system.

**DD**



### On “L1” from Past Issues of MMM

MMM #159 “Expanding the Manned Space Envelope: The Earth–Moon L1 Gateway” and #160 Constructing an L1 Gateway on a “Just-in-Time” Schedule (as Business & Industry would do it)

Both preserved in MMM Classic #16 pages 45–47 and 51–53 respectively. Download from [www.moonsociety.org/publications/mmm\\_classics/](http://www.moonsociety.org/publications/mmm_classics/)

**NOTE: “L1” and “L5” are esoteric terms for many!**

Dave Dietzler and Peter Kokh have been tossing about some more people–friendly names:

“**The Pass**” and “**The Lagrange Gap**”

i.e. through the “mountain ridge” between the Earth’s deep gravity well and the Moon’s shallower well.

See the illustration just below the title of this article.

Too many people have grown up with the proverbial dictum about there being no “up” and no “down” in space. For all practical reasons, in travel between gravity well destinations, this is a misleading sophism.

It is commonplace to show Earth–Moon and Earth–Mars trajectories in a flat plane, when it would be more helpful to show them against a gravity well map. Yes that is harder to do, like most things worth doing!

**Gravity Wells Comment:** Perhaps this is something we need to promote!

This should be part of our strategy of getting across to people the need to place infrastructure way stations to enable less expensive, more heavily trafficked personnel and cargo travel between Earth and Moon: LEO, GEO, and L1 were all bypassed by NASA because, for a low traffic operation like Apollo, it made no sense to invest in such infrastructure, and we all now understand that this “low traffic” assumption was/is a “self-fulfilling prophecy.”

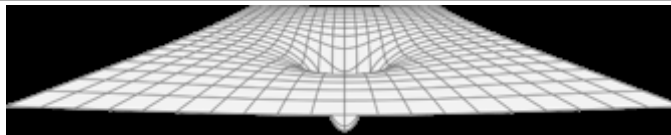

Above, how space is warped by a heavy mass “at the bottom of a gravity well.” Applies to all bodies of size: the Sun, Earth, Moon, Mars, Jupiter, etc.

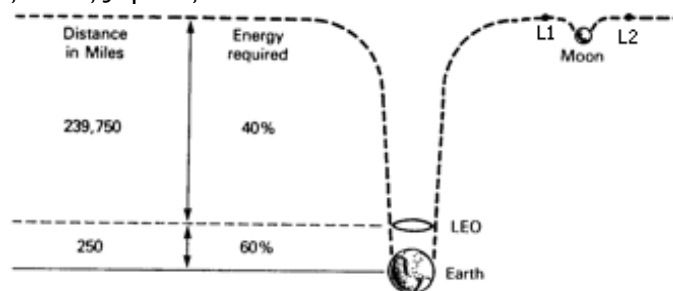

**Robert A. Heinlein** first noted, “once you are in Earth orbit, you are halfway to anywhere!”

Gravity Wells: an animated illustration

[http://www.opencourse.info/astronomy/introduction/06.motion\\_gravity\\_laws/gravity\\_well.gif](http://www.opencourse.info/astronomy/introduction/06.motion_gravity_laws/gravity_well.gif)

An illustration by our own Ken Murphy

<http://www.outofthecradle.net/WordPress/wp-content/uploads/spacefarersem1.jpg>

A great YouTube Explanation

[http://www.youtube.com/watch?v=VBOHtF3WhMw&feature=player\\_embedded](http://www.youtube.com/watch?v=VBOHtF3WhMw&feature=player_embedded)

“If Earth’s gravity well is 22 steps deep, the Moon’s gravity ‘dimple’ is only 1 step deep in comparison.”

The general “terrain” of the Solar System is like a great plateau, seemingly flat, but like the Great Plains States, gradually sloped uphill from the Sun outwards as this area is on the shoulders of the Sun’s giant gravity well.



## Salvaging the Google Lunar X-Prize “Also-Rans”

By David A. Dunlop, Moon Society Director of Project Development

### Google Lunar X-Prize –

[www.googlelunarxprize.org/lunar/about-the-prize/introductory-video](http://www.googlelunarxprize.org/lunar/about-the-prize/introductory-video)

[www.googlelunarxprize.org/lunar/about-the-prize](http://www.googlelunarxprize.org/lunar/about-the-prize)

[www.googlelunarxprize.org/lunar/about-the-prize/rules-and-guidelines](http://www.googlelunarxprize.org/lunar/about-the-prize/rules-and-guidelines)

[www.googlelunarxprize.org/lunar/teams](http://www.googlelunarxprize.org/lunar/teams)

### Opportunities, Incentives, and Tools For New Lunar Science Missions

#### Google Lunar X-Prize Teams

- Twenty teams are now vying for Google Lunar X-Prizes. While only two teams at best will win the 1<sup>st</sup> and 2<sup>nd</sup> prizes, the other team programs may offer potential options for further development. If so, their investments to date should not be wasted.
- Their merits with regard to technological innovation or cost-efficient models should be not go untested simply because they were not the first or second to land on the Moon.
- GLXP teams that do not win 1<sup>st</sup> or 2<sup>nd</sup> prize will require incentives and support to continue advancing their projects to flight readiness status and actual flight to the Moon.
- These also-rans may present opportunities to “re-purpose” their lunar landers to deliver needed or desired science payloads to lunar surface.
- Evaluation of each team’s design should be made in terms of
  - Risk reduction,
  - Technical feasibility
  - Cost efficiency
  - Suitability as platforms for lunar science missions that should be supported by the various national space agencies for those teams open to a follow-on incentives program to the original GLXP program.
- NASA and ILEWG (International Lunar Exploration Working Group) partners should support lunar program approaches and incentives that foster both international and commercial collaborations.

**Incentive Science Contracts** are an example of how this could work

- \$50M incentives should be offered for delivery of ILN (**International Lunar Network**) science packages comprising laser retro-reflector cube, seismometer, lunar radiation monitors, and heat flow probes – <http://nasascience.nasa.gov/missions/iln>

#### Technology Incentives

- A. NASA and DOE should offer RTG technologies as a missions-enabling technology incentive to lunar rover missions that deliver long duration sorties on the models of Pathfinder, Spirit, and Opportunity, and which address high priority science objectives. This should be jointly competed by ESMD (NASA Exploration Science Mission Directorate) and SMD (NASA Science Mission Directorate).

[http://en.wikipedia.org/wiki/Radioisotope\\_thermoelectric\\_generator](http://en.wikipedia.org/wiki/Radioisotope_thermoelectric_generator)

- B. Incentives should be created for technology demonstrations that use non-nuclear techniques to survive the lunar night cold temperature cycle, such as “Lunar Wadis” – see preceding article.
- C. Incentives should be offered and competed for principal investigators and teams which can demonstrate achievement of science goals that are on lunar science road map so that the process of lunar science missions development is more “granular” and financial “assets can be brought to the table” in consideration of lunar missions proposals by science investigators and teams whose instruments have been competitively qualified.

### **Open-Source Student Lunar Lander Engineering Missions**

As a means of driving down the cost of lunar transportation and creating opportunities for the next generation of lunar engineers and scientists, the ILEWG nations should support University-based engineering teams and networks working on a transparent open source basis.

Following the precedents of the ESMO (European Student Moon Orbiter) and ASMO (American Student Moon Orbiter), and **cubesat** projects ILEWG partner nations should all support at least one “open source” and “ITAR free” student lunar lander missions. This would create a pool of shared designs and platforms for engineering support of lunar landers and rovers and the expansion of the “lunar robotic village” by 2020.

These student lunar lander platforms should be cost justified by the requirement to deliver lunar a greater volume of lunar science packages to the surface, the need for technology demonstrations on the lunar surface, and the support of engineering workforce development goals.

### **An Open-Sources Science Proposals Database**

An open data base for lunar science missions proposals should be created which identifies principal investigator, sponsoring organization, proposed science instruments, Their Technology Readiness Level, Lunar Science road Map Objectives, mass, power requirements, cost, so that the lunar community of interest is easy to identify and the lunar mission “market” potential for lunar science is transparent. This database should build on the Lunar Orphans Flight Test (LOFT) list of NASA Lunar Commercial Services Commercial Crew and Cargo Office and the ESA Lunar Science Proposals Solicitation lists. All ILEWG member agencies should be invited to support this database. **DAD**

**MMM #238 – September 2010**

## **“In this decade” - JFK - 3 words that won us the Moon Race, but which have hamstrung us ever since**

When JFK gave his famous “We choose to go the Moon” speech, these three fateful words torpedoed Wernher von Braun’s plan. Sure he got to be in charge, but it was no longer his tune to which we would march. We could not delay achievement of the real goal, beating the Russians, and Oh, by the way, we will visit the Moon .... To set up a logical infrastructure along the way so that if we planned to stay, we could do so with an economical space transportation system. We were in a race, and the Moon was just a handy goal, dispensable once met. We would not delay the race to build an orbiting depot and assembly station. We would never have gone to the Moon as all, if it were not a way to trump the Russians big time, at their own game.

Those of us who were around at the time, when Nixon (not Congress) pulled the plug on Kennedy’s thing, were disappointed to be sure. But Saturn V was not the right vehicle and transportation system on which to build a sustainable Moon venture that included a permanent and growing presence. To stay, we would have had to pull the plug on Saturn V, which we did anyway, and start with a transportation system that involved logical nodes. And so began the campaign to convince President Reagan to give NASA a new goal, building a space station.

Well, we lost that one too. We got a space station of sorts, but it was a “yoyo space” thing, downward looking at Earth, and not a outer-space oriented depot or assembly station. It was even put in an orbit unfit to serve as a transfer point. Yes, that orbit was necessary to get the Russians to agree to partner with us, Clinton’s deal-clinching strategy to keep Russian scientists gainfully employed rather than out there looking for work in nations with mischievous intentions. Yes, the Space Station has done great things, and kept space in the public eye. But it is boundary layer space, not the outer space that includes the Moon and planets and beyond.

Once again, the space community mounted an effort to get the government to consider going back to the Moon. Both Bushes came up with flawed plans. By then NASA only knew one way to do the Moon, the wrong way. So along comes Mike Griffin, who gives us a Saturn V substitute, a way to get to the Moon without building the infrastructure that might allow us **to stay!**

Let's stop blaming Obama for halting what was a farce, in the first place. Let's stop cheering on Senators who would reverse Obama's decision. If we want to return the Moon "to stay," we have to abandon **Space Transportation 1.0**. We have to start with a clean slate, and brainstorm **Space Transportation 2.0**

What we have been trying to do for over forty years has been a pathetic reenactment of the tale of Sisyphus, the mythical Greek figure who kept trying to push a big rock to the top of a hill, only to lose the battle and watch it roll back to the bottom, retrace his steps and try again to push it to the top. We did not settle the west that way. We did not set out from the East Coast with a gigantic 50 ft wide half a mile long Conestoga wagon pulled by a team of a thousand horses. No, we built places along the way, St. Louis, Kansas City, Omaha, Denver, Salt Lake City, etc. At these stops we could replenish all our supplies, even personnel. At each stop, we dropped off things (passengers too) needed there and picked up new supplies, fresh people. Every waypoint made the next waypoint doable and at a reasonable cost. Going from Sacramento to San Francisco, the last step, was no more expensive than going a similar distance much further east.

So how do we take a page from the mid-1900s, a century and a half ago? It is pathetic that it is taking so long to learn what is really an obvious lesson!

### **Waypoints on the Road to the "Moon to Stay"**

Let's back up a bit. No I am not a rocket scientist. But rocket science is the problem. Why, because it is impatience that is always the problem. Building bigger and more powerful rockets is just making it more expensive to go nowhere.

It would seem that low Earth orbit is waypoint one. But I think it would pay to revisit how we launch from Earth. The most expensive thing is getting off the ground, and vertical launch is the most expensive way to do that. Fly back boosters, even rocket sleds, to launch horizontally to a level where the atmosphere is much thinner, need to be revisited. Always keep in mind that impatience is the enemy, the chief way we defeat ourselves in whatever we do. It simply should not take that much oomph to get us into orbit, or to the point where a smaller second stage could take over from a smaller first stage and successfully get the same payload into space. The masculine power trip way is not only not always the best way; it is almost always the worst way. So the first way point is the in transit level at which atmospheric resistance significantly drops off.

### **Low Earth Orbit**

We all know how useful low Earth orbit is. It is a great place to study the Earth. Our remote sensing and weather and navigational satellites have given us a much better understanding of our home planet. And the International Space Station has helped as a platform. It is also a great place to assemble things to large and/or to heavy to be sent up in one payload. To date, except for the Space Station itself, which proves the point, we have tried to avoid in-space assembly by building ever-bigger rockets for ever-heavier and larger payloads.

What we haven't yet got right is that every part of a rocket that makes it to low Earth orbit, could have been designed "transformer style" to serve as components for something to be assembled in orbit. We just throw that "stuff" away: fairings, spent stages, External Tanks!

For every ton of satellite mass in orbit, we have thrown many tons away that could not be integrated into something useful whether larger platforms, assembly and repair facilities, additional space stations or facilities for space stations. But then we are a throwaway people. Like our simian predecessors, who seemingly can't be house-broken, we apparently can't be planet-broken; it is easier to throw away and to trash than to reuse and reassign items and materials that have done their initial job. Had we not been so macho, and had been into husbanding everything that makes it into space, we could be decades ahead of where we are now, and probably without a space debris problem of such magnitude.



Impossible? If you think so, perhaps your imagination has become fossilized. Hold a design competition for ideas on what we can do with this or that throw-away item and prepare to be amazed at what still flexible minds can imagine! Get with the program or get out of the way. We'd all still be in the stone age if it were not so.

### **Geosynchronous Orbit**

Now we get to where it gets real fun! Perhaps most of us do not realize the scale of Geosynchronous orbit. At 23,000 miles above Earth's surface, 27,000 miles above its center, it is  $2\pi r$  or 170,000 mi. (230,000 km) in circumference. Yet, it is limited. We don't need our communications satellites slowly drifting into one another, so international agreement limits "stations" to 2 degree intervals. Dividing 170,000 by 180 gives us a spacing less than a thousand miles apart. But we already have well over 180 objects in GEO. And if and when we start building solar power satellites in GEO, and these things will be large, the situation could become dicey.

One way to alleviate crowding would be to build giant platforms that could provide power, station-keeping and repair services to dozens, hundreds, or even thousands of individual communications and TV relay units. Where would we get the materials to build such platforms? We need not build more GEO-bound rockets, but only design their rocket casings in a way that, again, "transformer-style," can self-unfold into platform strut sections. Maybe we need to mandate our rocket scientists and engineers to watch more Saturday morning cartoons – some of them probably never heard of the "transformers." Well, the kids and toymakers all know, so maybe when they grow up, they can turn things around.

Ultimately, of course, building materials for GEO platforms and SPS stations, can be shipped down from the Moon at much less expense than up the shorter distance from Earth. IF GEO is to be the linchpin of the 21<sup>st</sup> century economy (up from \$250 billion per year of economic value to \$250 trillion), lunar resources will be the principle enablers. (Mars will contribute nada, zilch.)

### **The Earth-Moon L1 Gateway**

This is the next waypoint, the "Sacramento" stage if you will. And in similar fashion, this gateway can be built up from components needed to get that far, but not going the rest of the way to the Moon's surface.

We will want an L1 Space Station with storage, even warehousing capacity, vehicle repair and maintenance facilities, fuel storage, cargo storage for trans-shipment, crew quarters for personnel in transit. L1 will grow apace with facilities on the Moon's surface, into a major transfer and service space-port in the sky.

If L1 doesn't grow, neither will the lunar frontier. Reuse of every last item that arrives there not going further, is the key. See our slide show on L1 growth:

[www.moonsociety.org/spreadtheword/pdf/L1phases.pdf](http://www.moonsociety.org/spreadtheword/pdf/L1phases.pdf)

### **The Moon's Surface**

Nor does our "transformer" routine stop at L1. Every part of a ship that lands on the Moon, and which is not needed for a return flight (100% if it is an unmanned cargo ship) should be designed for reuse or cannibalization on the Moon – down to the last strut, landing pad, fuel tank, --- everything, not just what's in the cargo hold – and that goes for packaging materials as well. To paraphrase a colorful description of rural southern cooking, using every part of the pig except the squeal (and maybe finding a use for that as well.)

Now I have just offended those who believe that reusability is the key to economy. No, not if you mean reusing the same thing over and over for its original purpose. To do that you have to get it back

to its original port and that is wasting fuel. Second, by reusing as is, you do not benefit from the economy of mass production. We don't need ten reusable rockets that get used a hundred times. We need a thousand rockets that get used only once, as a rocket, but then are put to permanent use taken apart and transformed into something needed on the frontier. Old timers will remember the World War Liberty ships, which we turned out cheap by the hundreds. Mass production and total reuse of materials at a destination – that's economy on steroids, if you will!

Yes things should be reused, but as materials, not as originally assembly components. We have to get into this new way of thinking about things and their utility. Look at a lander's legs and pads, and see a mobile crane! We may have to tweak original designs to get the most reuse potential out of them. And this redesign may cost some, but the rewards for reusability will pay off handsomely. Let's sponsor and run contests annually for the most innovative reuse of all these things used only once in transit. Let the young people clear the cobwebs in our older brains! We will fail if we do not pass the torch!

### **Summing up "Space Transportation 2.0"**

- # Every item that leaves Earth surface should be designed for reusability of its constituent parts or materials.
- # Components should be designed to serve some new function or purpose at the way station at which their original function has been achieved
- # Power is less important than economy and reusability
- # Nothing that can be used at a way station should be sent back down the line Earthwards. It is better in the long haul to keep sending up new rockets and rocket components that can be put to new use up the line, than to return them back down the line – false economy
- # Complete Hardware Utilization Mission Architectures = "CHUMA" (thanks to Dave Dietzler for this acronym)
- # Everything in the sacred traditional way of doing things should be reexamined in light of this new paradigm.
- # **The goal is not to return to the Moon.**
- # **The goal is not to return to the Moon to stay.**
- # **The goal is to return to the Moon and keep growing a lunar frontier civilization which in turn will feed Earth's needs in GEO and elsewhere and help us all rejuvenate and preserve the Eden that Earth once was. We are going to have to travel a lot of light years to find another like it.**

If this seems absurd, check out this report:

<http://www.foxnews.com/story/0,2933,529059,00.html>

We have to quit saying "we can't" when we haven't really tried. To the Moon, to stay! PK

**MMM #241 – December 2010**

## **Lockheed-Martin Proposes Tele-Robotic Exploration of the Moon's Farside From the L2 "Perch" using its Orion Crew Capsule**

By David A. Dunlop and Peter Kokh

**Proposal to Send Astronauts to Moon's Far Side**

By Leonard David: 23 November 2010

<http://www.space.com/news/moon-far-side-astronaut-mission-101123.html>

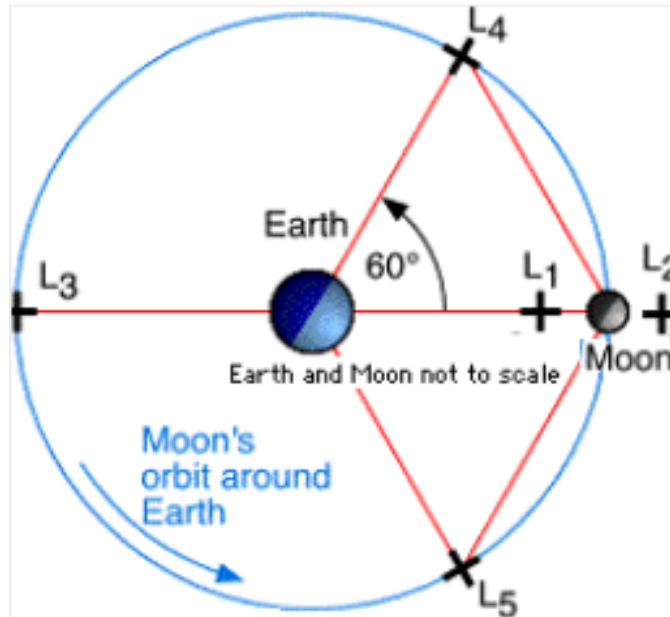
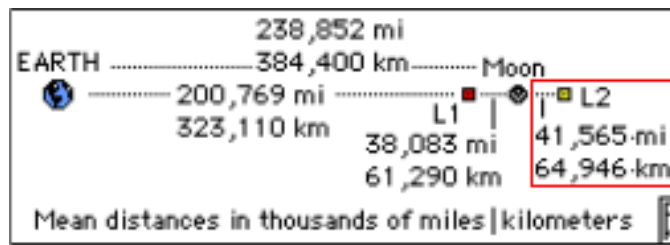

This proposal is a clever bit of "space strategy" in the context of the US political climate.– D. Dunlop  
**An L2 Mission and the new "Flexible Path"**

Instead of a Manned Space Program focused on the Moon, the new space paradigm is a "Flexible Path" that would use deep space missions of increasing difficulty to advance our capacity to operate beyond Earth orbit. Missions to near Earth asteroids, then to the moons of Mars have been identified as consistent with this goal.

But there just may be a neat way to sneak in a manned Moon Mission. Lockheed-Martin would not send its craft and crew to the Moon's surface but rather to the stable L2 point some 40,000 miles above the Moon's Farside,. Here the crew would be able to stay in contact with Earth but also teleoperate rovers on the Moon's farside surface that would investigate some of the Farside's secrets and mysteries. These science goals are at the top of the wish list of many, if not most, lunar scientists, as Farside is notably different from Nearside in several ways.

**Lockheed-Martin cites these mission plusses:**

- It could sharpen skills and technologies needed for a trip to an asteroid
- It showcases techniques useful for exploring Mars by teleoperation as astronauts orbit the red planet.
- It would serve as a "shakedown cruise" to practice medium duration missions and the higher-speed reentry needed for exploration missions before the next step – missions to asteroids.
- It would demonstrate additional capabilities for longer and more distant exploration before the Mars orbit mission.
- It would prove out the Orion capsule's life support systems for a one-month duration
- It would measure astronauts' radiation doses from cosmic rays and solar flares to verify that Orion provides sufficient protection, as it is designed to do

All of these demonstrations need to be done at any rate, and doing them from a point beyond the Moon, increasing our knowledge of the Moon and our operating abilities on its surface seem to this writer as a bouquet of plusses. Not to support this mission, because it is not the lunar human return mission we want, would be foolish.

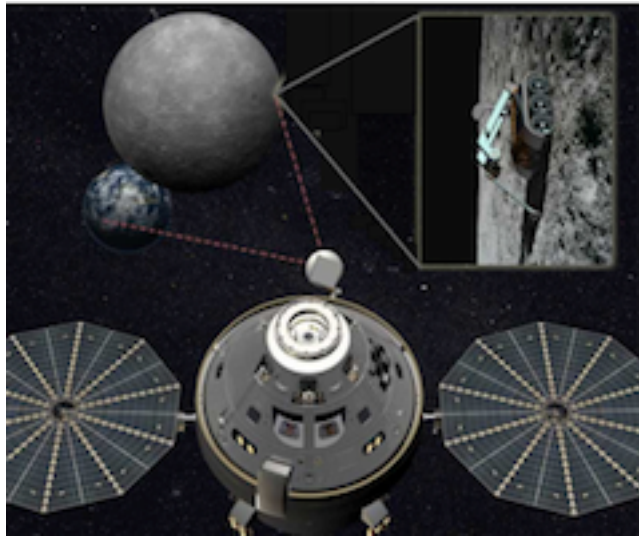

**Above:** The Orion craft left, with a view of farside while in line of sight with Earth, teleoperating surface rovers.

This proposal reinforces the Obama Administration's space goals of advancing NASA's mission to go beyond LEO to the asteroids and Mars while actually first going to the Moon to pursue lunar exploration goals that would otherwise be abandoned. This nicely positions it to be supported by the Republicans in control of the House and who favored the Constellation Moon program. It ensures continued funding for the Orion capsule, which is being built under Marshall Space Flight Center in Alabama, and it supports lunar lander projects.

#### **The Advantages of an L2 Teleoperations Perch**

From a "halo" orbit around the L2 Lagrange point where the Moon's and Earth's gravitational forces cancel each other out, at an average distance of 41,500 mi ~ 65,000 km above the center of the lunar farside, the Orion capsule could remain in-line-of-sight of Earth, essential for communications, while being able to tele-operate robotic equipment anywhere on the lunar farside surface below, something that otherwise cannot be done directly from Earth or Earth-orbits. The lunar "farside" is the side of the Moon never visible from Earth, as the Moon turns on its axis in the same period of time that it orbits Earth, always with the same "nearside" facing us. It is sometimes erroneously called the dark side of the Moon but Farside takes its turn in the sunlight just as does the familiar Nearside and on the same 29.5 day cycle.

The point is that there is much on the farside that has our scientific curiosity aroused. Lunar probes in low lunar orbit have mapped this whole area in visual light and other revealing wavelengths. But such craft, being out of line-of-sight of Earth at the time, cannot be used to relay teleoperation commands to robotic equipment on that side of the Moon. If we want "ground truth" landers and rovers to tell us more, we either have to fully automate them, letting them download their findings to orbiting craft when they pass overhead, for delayed relay to Earth, or we have to have such a perch as L2 from which human teleoperators can work directly.

Beyond operation of ground truth probes, at some time we might want to pre-construct landing areas, and places to store supplies for future manned surface missions. From L2, all this is possible. From L4 and L5 we can see 60° around the limb of each side of the Moon, but cannot see the central Farside 60° slice.

Having a lunar lander vehicle (which had been eliminated with the cancellation of the old Constellation program is also another way to "practice for Mars". The lunar exploration roadmap calls for a sortie mission capability to sample areas of the Moon other than those visited by Apollo. So these are "face-saving" ways to consider putting back the human lunar lander module in the NASA budget. In essence this is a way to have a Moon Program without calling it a Moon Program! But this is not part of the Lockheed-Martin Proposal.

#### **Hardware: Getting Orion to L2: Heavy-lift vs. Delta-V**

Another fight in Congress is about the development of a heavy lift launch vehicle versus man rating the Atlas V. This scenario show that it could be done either way. If an Atlas V was used to boost



Orion into LEO then another vehicle (Centaur) would have to rendezvous and dock with it to boost it beyond the Moon. The Orion capsule is too heavy to be boosted by the Falcon 9. So using Orion in essence makes the Atlas V the key launcher system for manned operations beyond LEO. It also creates a requirement for secondary launches to fuel these missions. That also is something that justifies fuel depot requirements, which is yet another strategic piece that is needed to routinely go beyond LEO and the ISS.

### **Salvaging parts of the puzzle**

Rendezvous and docking is another one of the strategic capabilities covered in the new Obama budget. Development of an unmanned heavy lift vehicle that uses shuttle-derived technologies and infrastructure is what Congress demanded and which keeps up employment levels at Marshall, Johnson, and Kennedy space centers. It would continue to use the space shuttle main engines, the external tank, and solid rocket boosters like the old shuttle system. It would however have a top mounted large (15 m diameter) faring. This is in essence the Direct Proposal that was an underground rebellion against the old Aries V design.

This is also a political fight within NASA and within Congress. Some at NASA want to see everything contracted out while others want to preserve a NASA government launch capability with its associated infra-structure and employment.

### **Political suspense**

The real issue is whether NASA will be deeply slashed and cut back to 2008 expenditure levels of \$17.4B from the recently agreed \$19B level or continued on the current spending level on a continuing resolution basis in Congress if no political agreements are reached.

### **Our curiosity about the Moon's Farside**

If you look at a globe of the Moon, the farside and nearside look like parts of two different planets. Some 2/5<sup>th</sup> of the nearside is covered by the dark lava plains, called maria (MAH-ri-a) or "seas." Lava basalt products will be a key early industry, and the pre-sheltered subsurface lavatube networks that are found in these "seas," may become the major areas for human settlement. The farside, in contrast, has a much smaller share of such dark, basaltic terrain.

And between the equator and the South Pole on farside, lies the deepest and largest lunar basin. As there are only scattered areas of subsequent lava flooding in this basin, it is expected that some of the basin floor may be covered with lunar mantle material, so far unsampled. However, some central peaks of larger craters may contain upthrust mantle material as well, and there are plenty of these on the nearside. But we won't know until we go there in person or with teleoperated mining equipment and samplers similar to Mars-bound Curiosity.

The growing interest in the Moon's farside is thus mainly a scientific one. But make no mistake; the farside will see its share of human frontier activity. Some of the relatively flat lava sheet areas may make ideal sites for extensive of radio telescope arrays, future successors to those at Socorro, NM and the larger array now being built in Chile's Atacama Desert: ALMA. [following article]

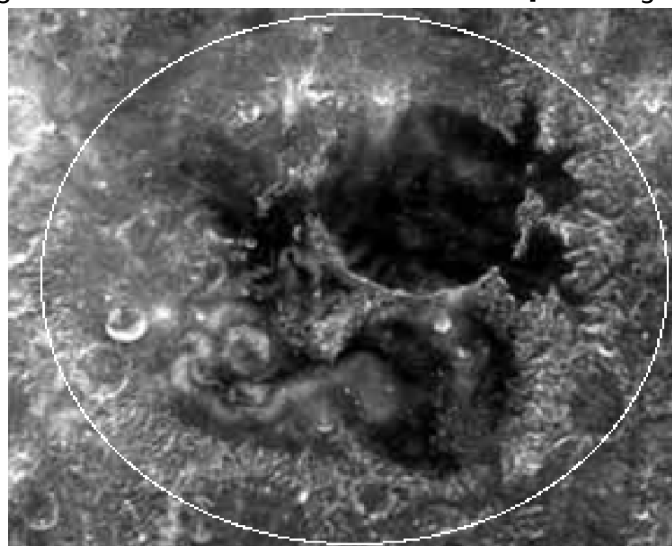

**Bottom previous page:** Mare Ingenii, which could host such an array, is of special interest because it has a small local magnetic field” antipodal to the point of impact that created the great nearside Mare Imbrium basin. The ionized plasma cloud from that impact surrounded the lunar globe in minutes, converging over Mare Ingenii.

**Below:** The Crater Tsiolkovsky has a dark sheet of lava covering it, with a magnificent bright central massif, Mt. Nikolas (if we follow our suggestion to name central Peaks with the first or given name of the person in whose honor the crater has been named) From a distance, such as from L2, this crater will stand out, proud.

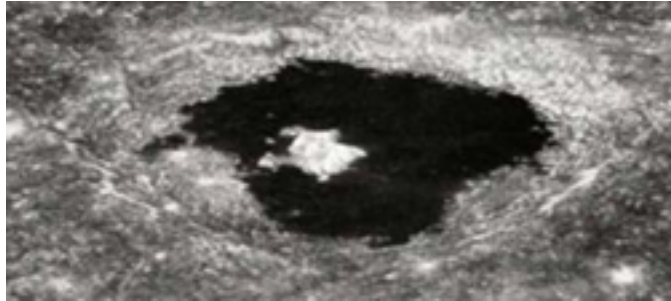

Some very low altitude areas in the Apollo crater might have mantle material on the surface. And then there is the most spectacular multi-ring “bullseye” impact basin on the Moon, Mare Orientale, just beyond the limb in Farside – **below..**

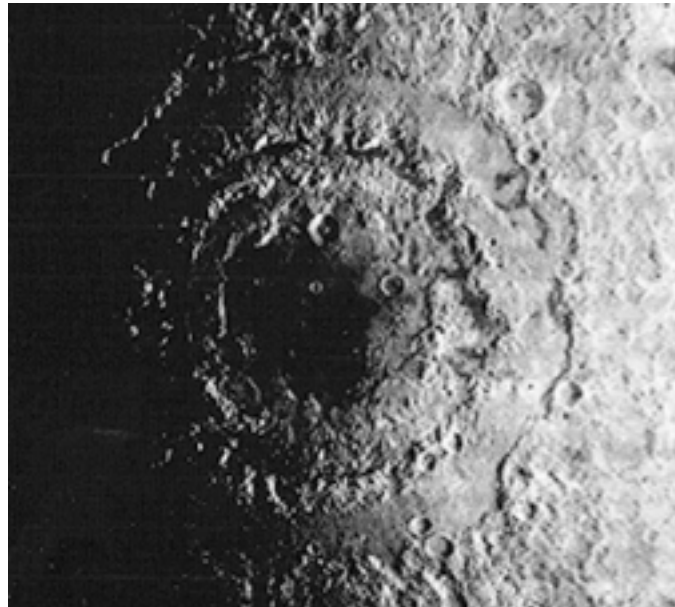

#### **Additional Science Goals on Farside:**

##### **The International Lunar Network Commitment**

There are international agreements NASA has signed for the development of an International Lunar Network. This initiative is also located a Marshall. It involves placing four different landers on the lunar surface. There is also a push for a lunar lander sample return mission at the South Pole Aitken Basin in the Science Mission Directorate competition for a large new mission. This proposal ties that mission to the manned mission so a number of lunar related missions are involved.

[http://en.wikipedia.org/wiki/International\\_Lunar\\_Network](http://en.wikipedia.org/wiki/International_Lunar_Network)

”The **International Lunar Network** or **ILN** is a proposed network of a series of landed stations of the **United States** and the other **space-faring countries** on the lunar surface in the 2010s. Each of these stations will act as a **node** in a lunar **geophysical** network. Ultimately this network could comprise 8–10 or more nodes operating simultaneously. In the ILN concept, each node will have a minimum of two core capabilities. These capabilities include seismic sensing, heat flow sensing, and laser **retro-reflectors**, and will be specific to each station. Because some nodes are planned to be located on the **far side of the Moon**, **NASA** will study a lunar communications relay satellite capability as a part of its

contribution to this project.[1]

“Individual nodes launched by different space agencies can and likely will carry additional, unique experiments to study local or global lunar science. Such experiments might include atmospheric and dust instruments, plasma physics investigations, astronomical instruments, electromagnetic profiling of lunar [regolith](#) and crust, local geochemistry, and [in-situ resource utilization](#) demonstrations.[1]”

Lunar Science Program, Science Mission Directorate, NASA.Solicitation Number: NNH09ZDA005L.  
Release Date: November 17, 2008

#### **While we are there: a Farside Phase Photo Set**

This Mission as proposed would last two weeks, allowing the crew to teleoperate probes and rovers on the surface for the full 2-week long dayspan duration at any one place. But we might want to teleoperate more than one rover at more than one place, mutually displaced east-west from one another, the mission would need to be longer to fit in partially overlapping local dayspans.

But for however long the crew is hovering over the farside, they could take daily Moon Phase photos. These photos are useful for the enriched long-shadow terrain details they show along the day/night and night/ day terminators. We have no such photos of the farside, and this inexpensive frosting project would contribute to public familiarity with “the rest of the Moon.”

Close-ups of areas ideal for a farside Radio Telescope array dedicated to the S.E.T.I. would also increase public interest; also photos of farside lava tube skylights.

The farside has much fewer lava flow mare areas; its crust seems to be notably thicker than that on the nearside; its southern South-Pole Aitken (“SPA”) basin is the largest and deepest on the Moon and may expose deep mantle materials not sampled by the Apollo crews.

#### **Where does advocacy come in?**

While such a mission would not put humans on the Moon, it would increase our knowledge of the Moon and could fill in many blind spots in our grasp of the Moon’s history and future potential. Further, it would keep the Moon in the public eye, increasing support for a future manned return.

The Moon Society has yet to consider taking a position on this option! We do not know if there is an NSS position. Speaking for myself, this sounds like a win-win proposal for both lunar and Flexible Path advocates. Time will tell if it goes anywhere. But we see no downsides.

MMM

## MMM #242 – February 2011

### **Telepresence-operated “Robonauts” will revise all “Scenarios”**

By Peter Kokh

At first impression, those of us who want to see human frontiers develop “and prosper” on the Moon, Mars, the asteroids and elsewhere in the Solar System may think that the emergence of robonauts threaten that dream. But quite the opposite is likely. These “stand ins” will pave the way at far less expense,

We have already integrated “teleoperation” of equipment” into our expectations. Japan and Russia, as well as our own Carnegie-Mellon robotics team, have suggested that site preparation and many construction chores could save substantial amounts of time and money. It costs a lot to put a human on the Moon! Humans are most effectively assigned to chores that cannot be teleoperated. Teleoperated equipment will allow humans to go to the Moon to begin at once to do what only they can do.

Enter the “robonauts” and telepresence! Here the human controller on Earth “sees what the robonaut sees, feels what the robonaut feels.” This is ideal for scientific tasks – for example, where it is not the size, shape or weight of a rock which is of interest, but its chemical-mineralogical makeup.” Robonauts can collect samples of special interest, freeing humans of that tedious chore, so that when they arrive, they can examine a pre-selected collection, without wasting hours and days in field work.

Robonauts do not need food, rest or relaxation.

They can work around the clock, through a team of tele-presence operators on Earth. They do not get bored. Thus the quality of their work is more likely to be high. As to teleoperated equipment, there will be many chores which cannot be done into their manipulation tools, one of a kind chores, that could not be foreseen, or which will be so uncommon that it would not be cost-effective to further specialize those tools and programs. A robonaut with hands human-like in their degrees of motion, can use hand tools for a limitless list of special tasks. Robonauts can do things too dangerous or risky for human crews. T companions can relieve humans of all sorts of risky and tedious chores.

In his article "O'Neills High Frontier Revisited and Modified" blow, Dave Dietzler shows how the emergence of robotic technologies also radically changes that scenario of how solar power satellites will be produced and deployed. No need for hyper expensive Space Settlements, that could delay the construction of SPS systems by many decades. Humans will still be involved, in lesser numbers, with far lower thresholds of support.

To sum up, lunar resources are still a best bet to lower SPS construction and deployment costs, but the cost of accessing those resources will fall by an order of magnitude or more by reducing the amount of human workers involved.

Consider that a lunar settlement can begin very small and grow as needed, module by module. In Contrast, a Space Settlement has to be built to a set size, whether it is occupied by a starter crew, or at full capacity. Space Settlements have a built-in high threshold, greatly exacerbated by the insistence on Earth-normal gravity levels. **PK**

## O'Neill's High Frontier Updated and Modified

By Dave Dietzler

Choosing the machines for the lunar industrial seed<sup>1</sup>, designing them and building them will require years of careful consideration and a small army of engineers, but there is no fundamental scientific or philosophical reason that this cannot be done.

### Introduction

It has been over thirty years since "**The High Frontier**"<sup>2</sup> was published and during that time most of the people I've discussed it with have agreed upon a modified version of things. In discussions and e-mails most of us have agreed that

The 100 million ton plus space colony is out of the picture and most SPS assembly work should be done in GEO with teleoperated robots.

O'Neill and others focused on the space colony and kind of slighted the Moon.

They figured the mining machines and mass driver would be launched from Earth with low cost Shuttle Derived Vehicles landed on the Moon in pieces and assembled by a crew of about 50 Moon miners<sup>3</sup>.

Raw regolith would be launched into space where it was processed into metals for construction, oxygen for rockets and excess raw regolith and slag that would be used for space colony radiation shielding as well as mass driver propelled space ship reaction mass. Regolith processing would be done at L5 construction shacks. These modular construction shacks would be launched from Earth, assembled in LEO and propelled with arc-jets to L5. The space colony would come next and 10,000 workers would be transported from Earth to do the work of SPS construction. Solar Power Satellites built at L5 would be moved down to GEO to sell power and start accruing profits.

The Moon plays a much more complex role in our vision. We will include tourism, astronomy and scientific research, SETI, asteroid mining, asteroid deflection and materials for ships to Mars and other destinations in the solar system. Moon mining will not be limited to simple open pit mining of regolith. Mining bases will be located on mare coasts where aluminum and calcium rich highland regolith as well as basaltic iron, magnesium and titanium rich mare regolith can be accessed.

There will be polar ice mining camps, KREEP mining in the Imbrium rim, mining of pyroclastic glass for native glass and elements that can be extracted from the surfaces of glass particles more easily than by extraction from complex minerals, and possibly even drilling for volcanic gases. Mining of vast areas of the mare for solar wind implanted volatiles including normal helium 4 and possibly helium

3 that are not likely to be found in polar ices of cometary origin – these all feature prominently in our vision.

Numerous mining bases will be linked by dirt roads and railways to mass driver sites and a circumlunar power grid will emerge for 24/7 power. All materials, or at least the 99.5%, needed for bootstrapping of lunar industry, creation of construction shacks and space tugs, and for SPSs will come from the Moon and possibly from the asteroids as well.

We are not certain about launching materials and finished products to L5. It might be possible to launch to L2 mass catchers and then haul cargos down to GEO or even launch directly to GEO. It might also be more plausible to launch to LLO (low lunar orbit) and collect the payloads, and then haul them down to GEO.

It is probable that L5 will not be very important and that construction shacks will all be located in GEO and that these will be mostly robotic.

While the nearly three second lag time that exists for teleoperation of robots on the Moon will hamper robotic operations on the Moon but not prohibit them entirely, the fraction of a second lag time for teleoperation of robots in GEO will not be a significant barrier to robotic construction in space.

### Transportation System

Earlier it was thought that the space shuttle or a space shuttle-derived vehicle would launch cheap and that LH2/LOX fueled rockets would be used to propel cargoes from LEO to the Moon. Our view is quite a bit different. Launch costs are high, even with Falcon rockets that offer the lowest price to LEO at present.

- We propose the use of **electric drives** to move cargoes from LEO to an L1 space station economically. Propellant masses for electric drives will be only a fraction of the mass of the cargo. Chemically propelled rockets would require propellants that amass several times the cargo mass and subsequently the cost of launching this extra mass to LEO would be several times higher than with electric drives.
- At the **L1 station** space storable water from lunar polar ice would be converted to LH2 and LOX for landers. The first payloads would consist of solar panels, digging machines, regolith refining equipment and fueling systems for aluminum and liquid oxygen powered reusable landers.
- **Lunar fuels** must come on-line early to eliminate the cost of launching propellants for landers from Earth's surface to LEO.

### Bootstrapping and ISRU [In Situ (Latin for “on site”) Resource Utilization]

We will not ship a complete mining system to the Moon and then focus on space construction. To reduce upported<sup>4</sup> mass and costs, we will land an industrial seed that will include manned habitat to bootstrap up industry on the Moon.

We will start out with small mining machines and build bigger ones. We will even build the mass driver or drivers on the Moon. We will mine at **multiple sites** (poles, mare coast, pyroclastic glass fields, KREEP terrains, crater central peaks, lava tubes, perhaps even drilling near volcanic domes) to get all necessary materials and link the mining sites with railroads to the mass driver sites.

Several years, perhaps decades, of work will be needed to build up industry on the Moon to the point at which SPS construction can begin. Long-term bonds will have to be sold to finance this project along with support from international governments.

The bootstrapping and ISRU concept will be applied to the SPS construction shacks too. We will launch the “bare bones” for these stations from Earth and enlarge them with metals and finished products from the Moon until we have the space infrastructure needed to build SPS. The construction shacks will be located in GEO. Lunar mass drivers will launch materials into space and mass catchers will haul those materials to GEO instead of L5. The GEO construction shacks will house only enough humans to supervise the robots that are teleoperated by Earthside crews with only a fraction of a second lag time for radio waves to travel from Earth to GEO and back.

### More Brains Equals Less Payload and Lower Costs

The construction of lunar industry and SPSs will require a lot of planning and intelligence to figure out just how to do; But physically, it will involve no more time, energy, robot labor and manpower than building a giant space colony for 10,000 people would!! Why build that space colony when we need

more infrastructure on the Moon and 90%+ work in space can be done with teleoperated robots and ground crews around the world connected by the internet???

We need more than just a single strip mine in the mare. While the **mare** can supply plenty of iron, titanium, magnesium, silicon and oxygen and lesser amounts of aluminum and calcium, the **high-lands** can supply more vital aluminum and even cement produced by roasting highland soil in solar furnaces. There are highland areas where the regolith is 98% anorthite and this would be ideal feedstock for aluminum, calcium, silicon and oxygen production.

**Calcium** might become the conductor of choice since it is a better conductor than copper and highland soil is richer in this metal than mare soil. Calcium metallurgy and manufacturing for out-vac cables and perhaps even mass driver coils must be developed. So the coasts become attractive.

There might even be blasting into hard rock with magnesium/LOX-based explosives if we find rock out-crops rich with industrial metals. The Imbrium coast is attractive because it contains lots of KREEP that can supply rare earth elements, potassium, phosphorus, thorium and uranium.

The Aristarchus pyroclastic glass fields that could supply nickel, copper, zinc, gallium, chlorine and other elements and the Marius Hills beneath which there might be chambers of volcanic gas evoke curiosity. Crater central peaks have never been sampled. Could they contain heavier elements thrust up from the mantle?

I have speculated that since chromite is found in mare regolith, and this heavy mineral sinks in lava to form thin layers like those of the Bushveld igneous complex in South Africa, there might be layers of chromite deep beneath the mare that have been thrust up in some crater central peaks. If so, this would be quite a find, since chromite is a source of the vital industrial metal chromium.

The best mining sites and the best mass driver sites might not match so it will be necessary to build a **system of roads and railways** to link them. While it has been stated that mineral processing would be best done in space where solar energy is constantly available, a system of cables and solar power plants at the limbs of the Moon could supply energy to mining and mass driver bases constantly and when we are looking at things on this scale it should not be impractical to build a lunar power grid. It's also possible that a lunar power beaming system might prove to be superior to GEO powersats. The major obstacle here is not the construction of vast solar power farms at the limbs of the Moon for LPS but the construction of transmitting dishes miles in diameter. Perhaps large farms of small phased array dishes could do the job of transmitting microwaves 240,000 miles to reasonably sized rectennas on Earth but I am no expert when it comes to this so I might be way off target.

Choosing the machines for the lunar industrial seed, designing them and building them will require years of careful consideration and a small army of engineers, but there is no fundamental scientific or philosophical reason that this cannot be done. Three dimensional printers guided by computers that can crank out parts made of basalt, glass and metals could be at the heart of the bootstrapping lunar industrial seed. Robots will be key to assembly work.

Metal casting seems likely, but we will rely on cold working like forging and extruding as much as is possible. A manned presence will also be essential. Skilled human workers are the ultimate multi-purpose robots. Humans might need biological sustenance, rest and recreation, but we are very versatile. Robots tend to be better and rapid repetitive jobs where high accuracy and reliability are required.  
**DD**

## The new Space Age Era of Human-Robonaut Synergy

By Peter Kokh

Robotics has come a long way in the past six years! And the promise is becoming real. Robotic assistants can relieve humans of tasks that are dangerous, boring, tiring, repetitious, etc. And they do not need life support, rest, entertainment, or socializing. They will not only pave the way for humans, but work side-by-side with humans after crews arrive, with future settlers also.

Whether the word "robonaut" sticks, or becomes replaced with the earlier "droids" (short for androids) is immaterial. The evolution of humans and robots working together is now well underway. Ro-

botic assistants can take care of chores that are boring, tedious, repetitious, and/or dangerous. They do not need food, rest, sports, relaxation, or entertainment. They do not require life-support in transit or on the job. They do not produce wastes that need to be treated and recycled.

As for **R2, now aboard ISS**, the coming year will see it undergoing tests to make sure the trip to the space station caused it no trouble. Astronauts aboard the station will have a chance to get used to R2 and learn to work with it/him. In time, both will become comfortable working together. We need to get to the point where we can trust robonauts as reliable helpmates. No one can predict how long that will take, as adjustments in the robonaut's capacities and abilities may be needed. In the real world, needs emerge which might not have been foreseen.

One big challenge for NASA engineers has been to retrofit all of the robot's electronics to withstand radiation in space. They also worked to make Robonaut 2 as "smart" as possible. R2 has some 38 Power PC processors, including 36 embedded ones. The embedded chips are running in the machine's joints: its hands, shoulders, waist, elbows, neck and five large joints in each arm.

NASA also plans on periodically upgrading R2, it will be attached to a pedestal on the space station and it will work in place. By year's end, one or two legs may be installed to allow R2 to move around the station. A single leg could be easily attached to the robotic arm outside the space station so it can assist astronauts during spacewalks. In time, R2 could relieve astronauts of EVA assignments. Unlike humans, robonauts will not have to go through time-consuming pre-breathing steps. EVAs are risky and tiring.

We can expect to see robonauts fully integrated into ISS crews, becoming comfortable and reliable as partners, with a significant increase in overall mission productivity. Meanwhile, we will probably see robonauts become common in upper income households (as in the Jetsons cartoon series.) The "humans vs. robots" debate will become a curiosity of history. Both sides will have won, and the future of space activities will unfold more quickly and at less expense.

Some science fiction scenarios foresee humans in danger of replacement. Some see "Borg-like" transformations of humans. We see robonauts becoming faithful and enabling companions to humans, a path that dogs have been down long ago. Robonauts will hasten and deepen the pioneer settlement of space frontiers. Science-fiction stories that do not include this partnership will become dated. We have lived to see the day when this brighter, more promising future was introduced! **PK**

*The Dennis Cripps Cartoon*



The MMM Editor boarding the Moonship for Luna City

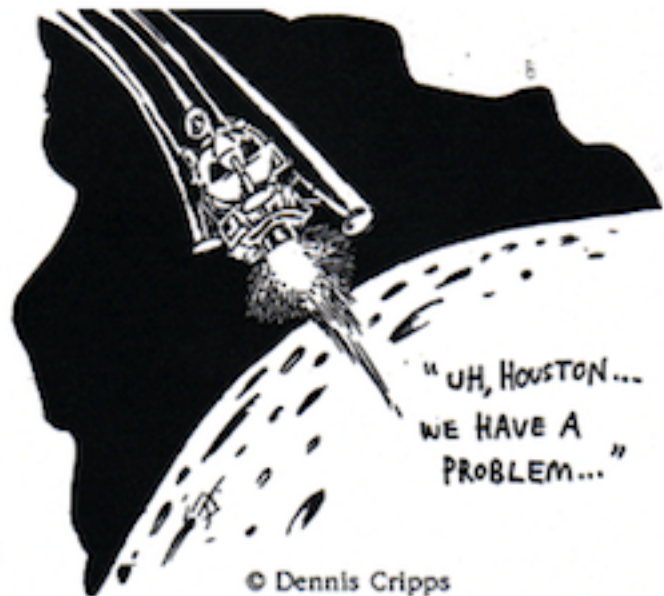

Whoops, only one landing pad is deployed!

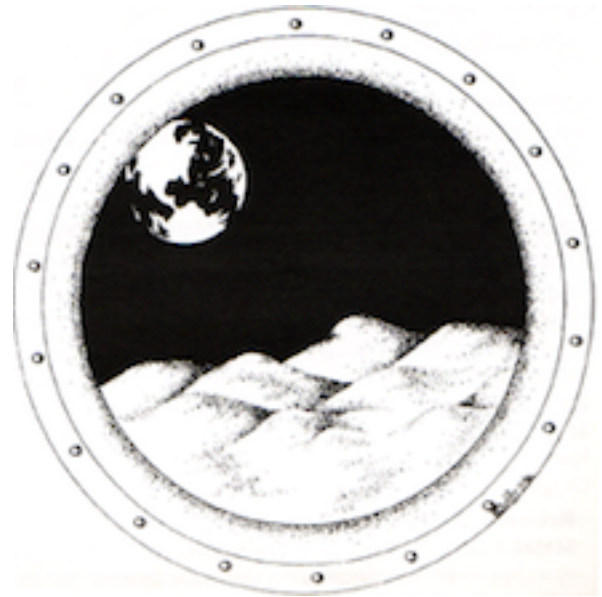
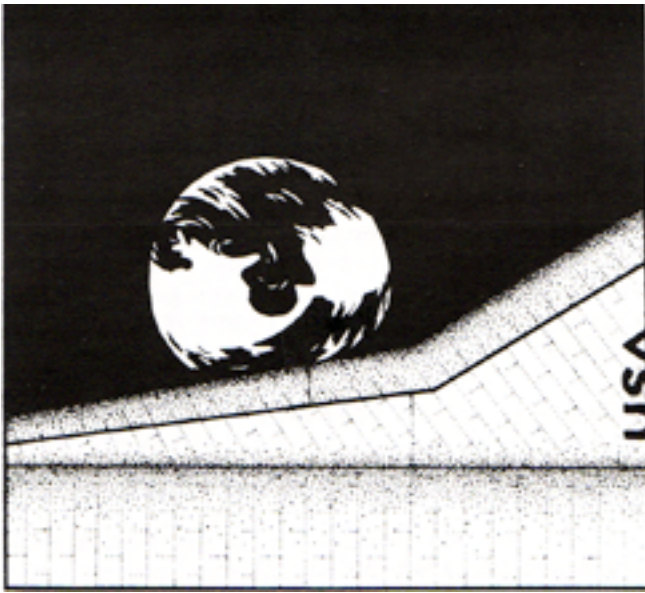

Transformer Toys set the bar for Space Vehicle components that can be given new assignments on the Moon.