



University of Luna Project™



Research
Students
Enterprise™

Launching

The University of Luna Project



Launching the University of Luna Project



- **Our long term Vision** is of the growth & development of **civilian lunar settlements guided by a University of Luna**
- Our Long term Mission is **to create the conditions** under which such an institution can and will arise - *by work now*
- Our strategy can be summed up as the “**University of Luna Project**” - [ULP]

painting by Pat Rawlings with permission

The University of Luna Project: *What & Why*

- *In the first settlements on the Moon, the pioneers will be challenged by the unfamiliar environment and unfamiliar resources.* They must develop new processing and manufacturing methods, and ways to use substitute materials to meet their needs and minimize the total mass of imports. They will need new farming and gardening methods. They will need assistance in developing new enterprises, new art media and techniques, new sports, and lunar-appropriate forms of recreation and healthy lifestyles.

The University of Luna Project: *What & Why*

- *In the first settlements on the Moon, the pioneers will be challenged by the unfamiliar environment and unfamiliar resources.* They must develop new processing and manufacturing methods, and ways to use substitute materials to meet their needs and minimize the total mass of imports. They will need new farming and gardening methods. They will need assistance in developing new enterprises, new art media and techniques, new sports, and lunar-appropriate forms of recreation and healthy lifestyles.
- *A University of Luna could help develop the tools to make it easier for pioneers to adapt to their new environment, and to thrive and prosper.*

The University of Luna Project: *What & Why*

- *In the first settlements on the Moon, the pioneers will be challenged by the unfamiliar environment and unfamiliar resources.* They must develop new processing and manufacturing methods, and ways to use substitute materials to meet their needs and minimize the total mass of imports. They will need new farming and gardening methods. They will need assistance in developing new enterprises, new art media and techniques, new sports, and lunar-appropriate forms of recreation and healthy lifestyles.
- *A University of Luna could help develop the tools to make it easier for pioneers to adapt to their new environment, and to thrive and prosper.*
- *But there will be no Lunar Frontier and no University of Luna on the Moon if we do not learn more about the Moon now, and pre-develop now the key technologies to expand from a first outpost towards real enterprise-based settlement. *To lay these foundations we are launching “The University of Luna Project.**

U. of Luna Project Department Structure: **Areas in which we must do R&D *now* - I**

SELENOLOGY DEPT

- ✓ Completing the Economic Geography of Lunar Resources
- ✓ Data Mining Projects
- ✓ Identification of logical Transportation Corridors
- ✓ Ground Truth landers & rovers
- ✓ Feature and Place Name Registry
- ✓ Identification of areas of Geological, Scenic, Historical value for protected status

U. of Luna Project Department Structure:

Areas in which we must do R&D *now* - I

SELENOLOGY DEPT

- ✓ Completing the Economic Geography of Lunar Resources
- ✓ Data Mining Projects
- ✓ Identification of logical Transportation Corridors
- ✓ Ground Truth landers & rovers
- ✓ Feature and Place Name Registry
- ✓ Identification of areas of Geological, Scenic, Historical value for protected status

ENERGY DEPT.

- ✓ He3 extraction, handling, shipping
- ✓ Lunar Solar Power Systems
- ✓ Power Storage System
- ✓ Dayspan/Nightspace Operations
- ✓ Recycling of embodied energy
- ✓ Energy efficiency research
- ✓ Industrial parks organized into a thermal cascade
- ✓ Lunar sourceable fuels
- ✓ Mass driver systems for bulk export
- ✓ Mass catcher systems for import

U. of Luna Project Department Structure:

Areas in which we must do R&D *now* - II

ASTRONOMY DEPT

- ✓ Farside radio astronomy
- ✓ Optical astronomy installations
- ✓ Telescopes for Lunar amateurs

LUNAR TECHNOLOGY DEPT

- ✓ Mining & Processing Technologies
- ✓ Lunar-deficient element sources
- ✓ Lunar Satellite systems research
- ✓ Water-conserving Manufacturing
- ✓ Dust control systems
- ✓ Lunar-Appropriate Industrial Design - MUS/cle Design Projects
- ✓ Disassembly-friendly assembly for proper recycling

U. of Luna Project Department Structure:

Areas in which we must do R&D *now* - II

ASTRONOMY DEPT

- ✓ Farside radio astronomy
- ✓ Optical astronomy installations
- ✓ Telescopes for Lunar amateurs

LUNAR TECHNOLOGY DEPT

- ✓ Mining & Processing Technologies
- ✓ Lunar-deficient element sources
- ✓ Lunar Satellite systems research
- ✓ Water-conserving Manufacturing
- ✓ Dust control systems
- ✓ Lunar-Appropriate Industrial Design - MUS/cle Design Projects
- ✓ Disassembly-friendly assembly for proper recycling

MATERIALS RESEARCH DEPT

- ✓ Concrete
- ✓ Glass, glass fiber, glass composites
- ✓ Ceramics
- ✓ Cast basalt
- ✓ Metal alloys

ARCHITECTURE

- ✓ Modular architecture system
- ✓ Surface structure architecture
- ✓ Shielding systems
- ✓ Warehouse systems
- ✓ Flare sheds
- ✓ Construction systems
- ✓ Low gravity Stair / ladder design

U. of Luna Project Department Structure:

Areas in which we must do R&D *now* - III

AGRICULTURE & BIOSPHERE

Agriculture & Food Processing

- ✓ Development of new hybrids
- ✓ Biological Diversification project
- ✓ Wild Areas project
- ✓ Food processing
- ✓ Biomass waste recycling
- ✓ Fiber production
- ✓ Pharmaceutical production
- ✓ Climate options

Lunar Biospherics research

- ✓ Modular biospherics
- ✓ Graywater and blackwater systems
- ✓ Environmental protection protocols

U. of Luna Project Department Structure:

Areas in which we must do R&D *now* - III

AGRICULTURE & BIOSPHERE

Agriculture & Food Processing

- ✓ Development of new hybrids
- ✓ Biological Diversification project
- ✓ Wild Areas project
- ✓ Food processing
- ✓ Biomass waste recycling
- ✓ Fiber production
- ✓ Pharmaceutical production
- ✓ Climate options

Lunar Biospherics research

- ✓ Modular biospherics
- ✓ Graywater and blackwater systems
- ✓ Environmental protection protocols

ARTS DEPARTMENT

- ✓ Made-on-Luna art media
- ✓ Made-on-Luna music instruments
- ✓ Lunar performing arts forms

TRANSPORTATION DEPT

- ✓ Vehicles for pressurized roads
- ✓ Design of surface highways and vehicles for various use
- ✓ Design of self-help roadway service stations, flare sheds, hostels
- ✓ Lunar railway & cableway systems
- ✓ Human-powered cycles for 1/6th G
- ✓ Suborbital transports and runways

U. of Luna Project Department Structure:

Areas in which we must do R&D *now* - IV

SPORTS & RECREATION DEPT

- ✓ Sports designed for lunar 1/6 th G
- ✓ Dance forms for 1/6 th G
- ✓ Out-vac (external surface vacuum)
recreation and sporting activities

FRONTIER MEDICINE / HEALTH

- ✓ Compact full-function hospitals
- ✓ Frontier first aid kits and systems
- ✓ Research in Earth-orbiting facilities
with 1/6th normal artificial gravity
for early cues of physiological and
other health problems in 1/6th G
- ✓ Nutritional diets for 1/6th gravity

U. of Luna Project Department Structure:

Areas in which we must do R&D *now* - IV

SPORTS & RECREATION DEPT

- ✓ Sports designed for lunar 1/6 th G
- ✓ Dance forms for 1/6 th G
- ✓ Out-vac (external surface vacuum) recreation and sporting activities

FRONTIER MEDICINE / HEALTH

- ✓ Compact full-function hospitals
- ✓ Frontier first aid kits and systems
- ✓ Research in Earth-orbiting facilities with 1/6th normal artificial gravity for early cues of physiological and other health problems in 1/6th G
- ✓ Nutritional diets for 1/6th gravity

HUMAN RESOURCES DEPT

- ✓ Production-supporting roles for seniors, children, adolescents, etc.
- ✓ Tasks to outsource to teleoperators on Earth to free pioneers for export and domestic production needs.
- ✓ Tasks for the antisocial element

POLITICAL SCIENCE DEPT

- ✓ Determination of the minimum needs for domestic home rule
- ✓ Developing a pre-agreed upon schedule for phasing in autonomy
- ✓ Earth Political, Economic, Cultural, Relations

Research Tools



- Lunarpedia.org
An open-source online Moon-focused Encyclopedia launched in January 2007
- **Data Mining Projects**, gaining fresh insights from data of lunar missions already flown - *engaging students*
- **“Spin-up” Enterprises** - doing the R&D for technologies needed on the Moon - *now* - for the sake of potentially **profitable terrestrial applications**, thus putting these technologies “on the shelf,” the bill for the R&D paid for by consumers - *engaging enterprise*

Research Tools

- Lunarpedia.org
An open-source online Moon-focused Encyclopedia launched in January 2007
- **Data Mining Projects**, gaining fresh insights from data of lunar missions already flown - *engaging students*
- **“Spin-up” Enterprises** - doing the R&D for technologies needed on the Moon - *now* - for the sake of potentially **profitable terrestrial applications**, thus putting these technologies “on the shelf,” the bill for the R&D paid for by consumers - *engaging enterprise*



- **Listing Masters & Doctoral Theses Topics** that address specific research holes - *engaging students*
- **Targeted College Engineering & College Design Competitions & Contests** - *engaging students*
- **Research-focused Curricula Development** - *engaging students*
- **Envelope Pushing Workshops**
- **Involving Universities and Corporations**
- **Lunar Analog Research Stations**

University of Luna Project *Operations*



Where will the Research be Done?

- ✓ At universities and colleges anywhere
- ✓ In corporate labs
- ✓ Wherever there is someone willing to take up the challenge

The University of Lunar Project will not compete for research funds

- ✓ The research dollars will go to the institutions and labs where the work is done

Launching the University of Luna Project

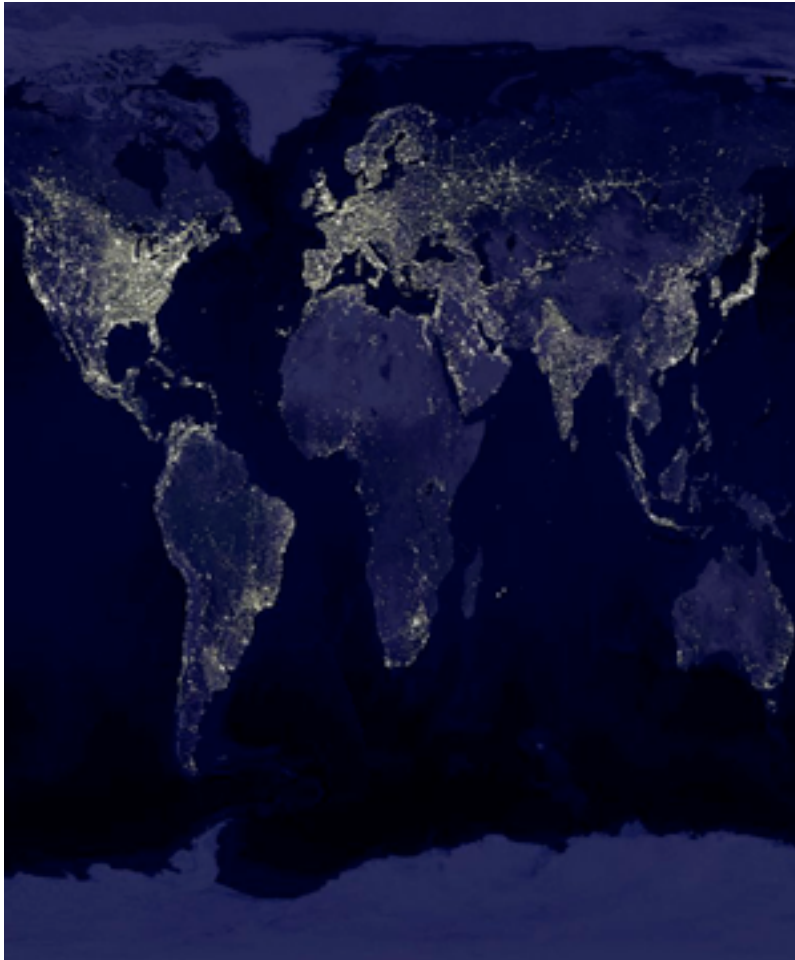

Whose Project is This?

- ✓ This is not a NASA project
- ✓ It is not a project of a consortium of national space agencies
- ✓ This is an open-source project to which anyone who believes the Moon has a place in our future is welcome to find a place and a way to contribute

We cannot plan the results

- ✓ What gets done will depend on the interests, talents, and energies of those who choose to participate
- ✓ *This could be your project !*

The University of Luna Project: a **Cyberspace Research Catalyst & Engine**

It will be broken into many parts

- ✓ Diverse projects
- ✓ In a large number of categories

What that means

- ✓ We need a a team of many individuals to oversee the work proposed and in progress in the areas they speak for
- ✓ There will be a number of website directories, with a team leader in charge of each
- ✓ The ULP will be a team effort

The University of Luna Project: a **Cyberspace Research Catalyst & Engine**

It will be broken into many parts

- ✓ Diverse projects
- ✓ In a large number of categories

What that means

- ✓ We need a team of many individuals to oversee the work proposed and in progress in the areas they speak for
- ✓ There will be a number of website directories, with a team leader in charge of each
- ✓ The ULP will be a team effort

Some teams will be more efficient and productive than others

- ✓ This can't be helped
- ✓ But everything we accomplish will help advance the day when the Lunar Frontier becomes a reality
- ✓ The more we accomplish, the more vigorous that frontier will be

No national space agency has the creation of an Earth-Moon economy as a goal

- ✓ That is a dream that is up to us to realize. We owe it to ourselves

Directing the University of Luna Project

This project is an initiative of The Moon Society

- ✓ However, it will function with full autonomy, having its own Board of Directors and its own Officers
- ✓ It will have its own budget and financing

Other space advocacy organizations are invited to cosponsor this initiative.

- ✓ Becoming a cosponsor does not involve a financial commitment, though a donation of any size would be welcome

Directing the University of Luna Project

This project is an initiative of The Moon Society

- ✓ However, it will function with full autonomy, having its own Board of Directors and its own Officers
- ✓ It will have its own budget and financing

Other space advocacy organizations are invited to cosponsor this initiative.

- ✓ Becoming a cosponsor does not involve a financial commitment, though a donation of any size would be welcome

Institutional sponsors are welcome

- ✓ Colleges, universities, individual university departments, and other institutions are invited to support this effort as a way to enhance and/or complement their own research programs

Industrial corporations and other enterprises of any kind are invited to support this effort

- ✓ To discuss ways in which you can participate, just send an email message to info@u-lunaproject.org

The University of Luna Project **in a Nut Shell**

- A “grass roots” effort on the part of those who believe that the Moon has a significant role to play in our future

The University of Luna Project **in a Nut Shell**

- A “grass roots” effort on the part of those who believe that the Moon has a significant role to play in our future
- United in activities aimed at providing the eventual pioneers with the tools they will need to succeed

The University of Luna Project **in a Nut Shell**

- A “grass roots” effort on the part of those who believe that the Moon has a significant role to play in our future
- United in activities aimed at providing the eventual pioneers with the tools they will need to succeed
- So that they can get off to a great start

The University of Luna Project: This Kind of Activity has Precedents - I

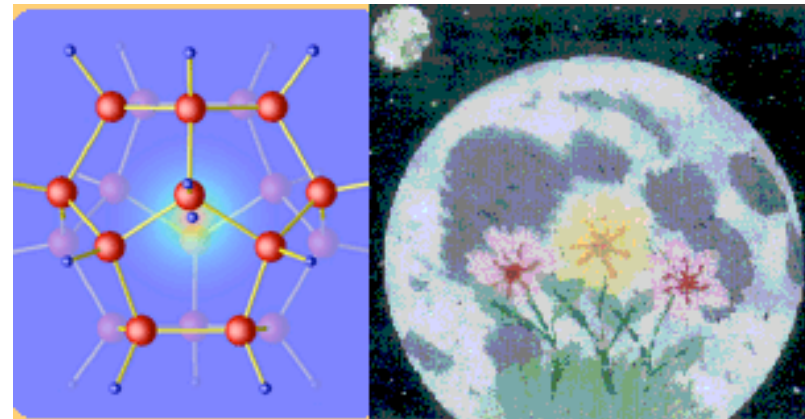
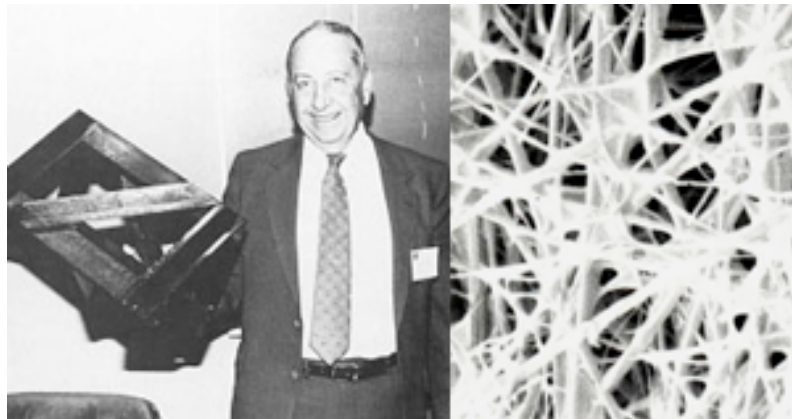
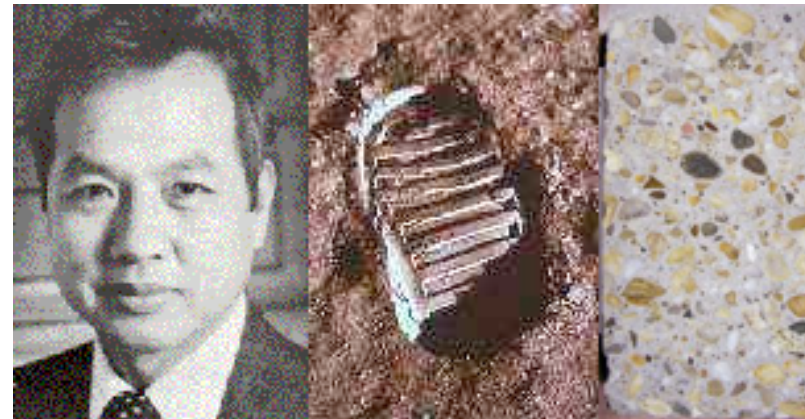
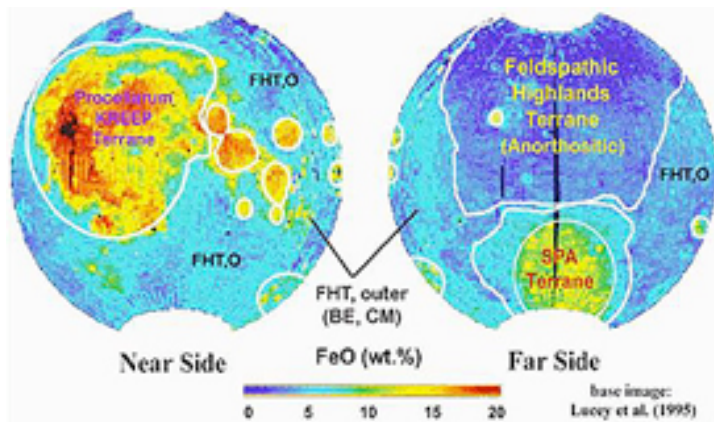

The University of Luna Project: This Kind of Activity has Precedents - II

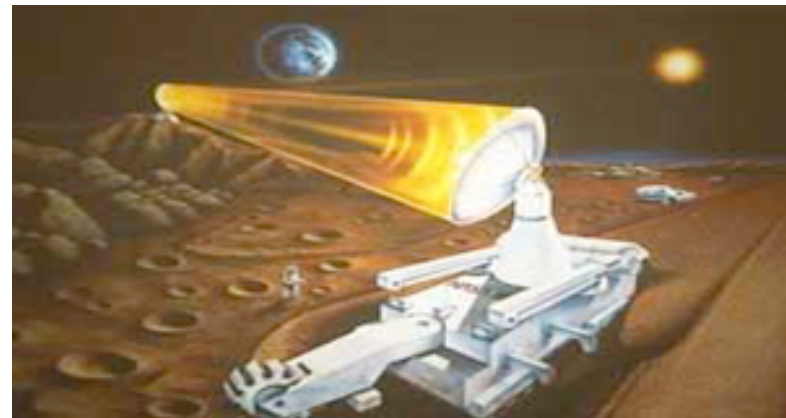
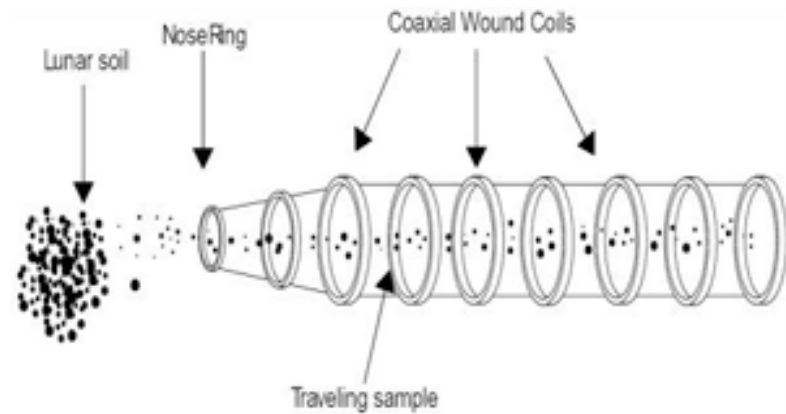
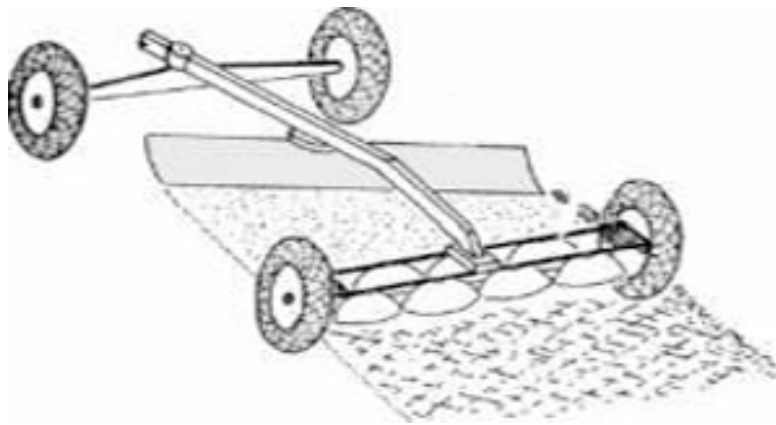

The University of Luna Project: This Kind of Activity has Precedents - III

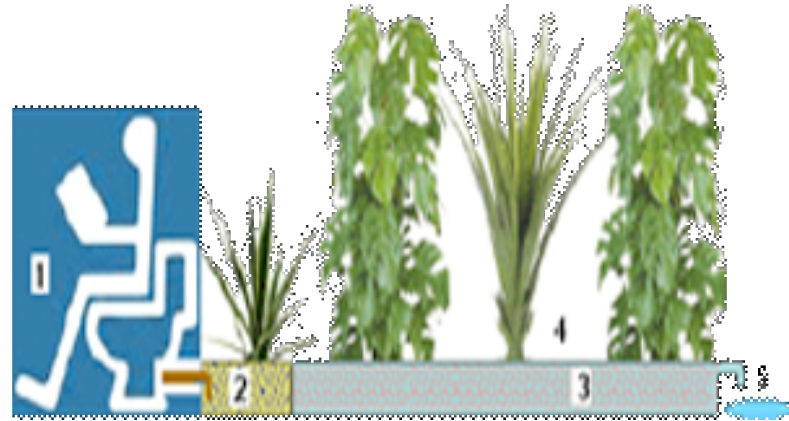
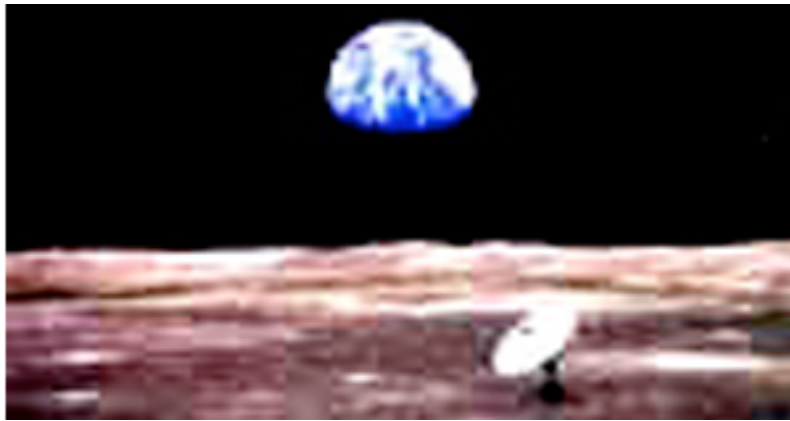

University of Luna Project - *Priorities*

- 1) Any and all **projects that engage youth**
The current generation will soon retire.
If we do not replace ourselves, it's over

University of Luna Project - *Priorities*

- 1) Any and all **projects that engage youth**
The current generation will soon retire.
If we do not replace ourselves, it's over
- 2) There is an urgent need to do what we can
to get the **instruments** flown that will
help complete the “**economic geography**”
of the **Moon's resources** and physical
assets of economic significance

The U-Luna Project: *Fast Forward*

Launching the real U-Luna on the Moon, *ASAP*



- Is this something that *will have to wait until* we have thousands of pioneers on the Moon?
- **No!** The University *on the Moon* can start off with the great bulk of its faculty on Earth, via the Internet and other real-time connections.
- Over time, the proportion of the faculty *actually on the Moon* will grow steadily
- UL-Luna City can start off with a hundred or so pioneers on the Moon and a handful of faculty

The Friends of The University of Luna Project

Any project as vast and comprehensive as this can be advanced by a
“Friends of” Organization

- ✓ The focus of such a group is **to complement the projects and programs** of the – *not to replace or duplicate services*

The Friends of The University of Luna Project

Any project as vast and comprehensive as this can be advanced by a
“Friends of” Organization

- ✓ The focus of such a group is **to complement the projects and programs** of the ULP – *not to replace or duplicate services*
- ✓ The Friends can arrange **introduction parties, educational events and organize fundraising efforts**
- ✓ The Friends of ULP can set up **speaking engagements, receptions, workshops and conferences** at various locations
- ✓ The Friends can do public outreach to **increase recognition, understanding, and support for the ULP’s vision, goals, and projects**

The Friends of The University of Luna Project

Any project as vast and comprehensive as this can be advanced by a
“Friends of” Organization

- ✓ The focus of such a group is **to complement the projects and programs** of the ULP – *not to replace or duplicate services*
- ✓ The Friends can arrange **introduction parties, educational events and organize fundraising efforts**
- ✓ The Friends of ULP can set up **speaking engagements, receptions, workshops and conferences** at various locations
- ✓ The Friends can do public outreach to **increase recognition, understanding, and support for the ULP’s vision, goals, and projects**
- ✓ The Friends can **arrange award ceremonies** in recognition of outstanding work in research and other areas
- ✓ **The Moon Society and other space activist societies** can help set up this “Friends of” organization

The University of Luna Project: U-LunaProject.org
Getting Involved - *Contact Info*

University of Luna Project™

- David A. Dunlop - dunlop712@yahoo.com
ULP Executive Director - 708-848-6605
- Peter Kokh - kokhmmm@aol.com - 414-342-0705
Chair of The ULP Board of Advisors

The University of Luna Project



The University of Luna Project

